

Ruckus FastIron Stacking Configuration Guide, 08.0.90

Supporting FastIron Software Release 08.0.90

Copyright, Trademark and Proprietary Rights Information

© 2019 ARRIS Enterprises LLC. All rights reserved.

No part of this content may be reproduced in any form or by any means or used to make any derivative work (such as translation, transformation, or adaptation) without written permission from ARRIS International plc and/or its affiliates ("ARRIS"). ARRIS reserves the right to revise or change this content from time to time without obligation on the part of ARRIS to provide notification of such revision or change.

Export Restrictions

These products and associated technical data (in print or electronic form) may be subject to export control laws of the United States of America. It is your responsibility to determine the applicable regulations and to comply with them. The following notice is applicable for all products or technology subject to export control:

These items are controlled by the U.S. Government and authorized for export only to the country of ultimate destination for use by the ultimate consignee or end-user(s) herein identified. They may not be resold, transferred, or otherwise disposed of, to any other country or to any person other than the authorized ultimate consignee or end-user(s), either in their original form or after being incorporated into other items, without first obtaining approval from the U.S. government or as otherwise authorized by U.S. law and regulations.

Disclaimer

THIS CONTENT AND ASSOCIATED PRODUCTS OR SERVICES ("MATERIALS"), ARE PROVIDED "AS IS" AND WITHOUT WARRANTIES OF ANY KIND, WHETHER EXPRESS OR IMPLIED. TO THE FULLEST EXTENT PERMISSIBLE PURSUANT TO APPLICABLE LAW, ARRIS DISCLAIMS ALL WARRANTIES, EXPRESS OR IMPLIED, INCLUDING, BUT NOT LIMITED TO, IMPLIED WARRANTIES OF MERCHANTABILITY AND FITNESS FOR A PARTICULAR PURPOSE, TITLE, NON-INFRINGEMENT, FREEDOM FROM COMPUTER VIRUS, AND WARRANTIES ARISING FROM COURSE OF DEALING OR COURSE OF PERFORMANCE. ARRIS does not represent or warrant that the functions described or contained in the Materials will be uninterrupted or error-free, that defects will be corrected, or are free of viruses or other harmful components. ARRIS does not make any warranties or representations regarding the use of the Materials in terms of their completeness, correctness, accuracy, adequacy, usefulness, timeliness, reliability or otherwise. As a condition of your use of the Materials, you warrant to ARRIS that you will not make use thereof for any purpose that is unlawful or prohibited by their associated terms of use.

Limitation of Liability

IN NO EVENT SHALL ARRIS, ARRIS AFFILIATES, OR THEIR OFFICERS, DIRECTORS, EMPLOYEES, AGENTS, SUPPLIERS, LICENSORS AND THIRD PARTY PARTNERS, BE LIABLE FOR ANY DIRECT, INDIRECT, SPECIAL, PUNITIVE, INCIDENTAL, EXEMPLARY OR CONSEQUENTIAL DAMAGES, OR ANY DAMAGES WHATSOEVER, EVEN IF ARRIS HAS BEEN PREVIOUSLY ADVISED OF THE POSSIBILITY OF SUCH DAMAGES, WHETHER IN AN ACTION UNDER CONTRACT, TORT, OR ANY OTHER THEORY ARISING FROM YOUR ACCESS TO, OR USE OF, THE MATERIALS. Because some jurisdictions do not allow limitations on how long an implied warranty lasts, or the exclusion or limitation of liability for consequential or incidental damages, some of the above limitations may not apply to you.

Trademarks

ARRIS, the ARRIS logo, Ruckus, Ruckus Wireless, Ruckus Networks, Ruckus logo, the Big Dog design, BeamFlex, ChannelFly, Edgellon, FastIron, HyperEdge, ICX, IronPoint, OPENG, SmartCell, Unleashed, Xclaim, ZoneFlex are trademarks of ARRIS International plc and/or its affiliates. Wi-Fi Alliance, Wi-Fi, the Wi-Fi logo, the Wi-Fi CERTIFIED logo, Wi-Fi Protected Access (WPA), the Wi-Fi Protected Setup logo, and WMM are registered trademarks of Wi-Fi Alliance. Wi-Fi Protected Setup™, Wi-Fi Multimedia™, and WPA2™ are trademarks of Wi-Fi Alliance. All other trademarks are the property of their respective owners.

Contents

Preface.....	9
Document Conventions.....	9
Notes, Cautions, and Warnings.....	9
Command Syntax Conventions.....	10
Document Feedback.....	10
Ruckus Product Documentation Resources.....	10
Online Training Resources.....	11
Contacting Ruckus Customer Services and Support.....	11
What Support Do I Need?.....	11
Open a Case.....	11
Self-Service Resources.....	11
About This Guide.....	13
Supported hardware.....	13
What's new in this document.....	13
Stacking Overview.....	15
Stacking.....	15
Network management and stack configuration.....	16
Switching and routing advantages.....	16
Campus Fabric.....	16
Ruckus stackable models.....	18
Stacking terminology.....	19
Stack unit roles.....	19
Stacking terms.....	19
Changes to Stacking in FastIron Release 08.0.90.....	23
Valid-stack-port sets.....	23
No more stack default-ports configuration.....	24
Stacking ports displayed even when stacking is not enabled.....	24
Changes to stack-port and stack-trunk configuration.....	25
General comparison of the new and old behaviors in configuring stacking ports and trunks.....	25
Comparison of configuration changes that use non-factory valid-stack-port sets.....	26
Comparison of common configuration procedures using factory-set default stacking ports.....	26
Changes to upgrade and downgrade for stacking from FastIron release 08.0.90.....	29
Upgrading to FastIron release 08.0.90 from earlier releases.....	29
Downgrading from FastIron 08.0.90 to earlier releases.....	30
Stack interactive-setup.....	31
Differences in stack unit replacement.....	32
Stack zero-touch provisioning.....	33
Stacking deployment guidelines.....	34
Constructing a new stack from scratch or adding new units to a stack.....	34
Replacing stack units.....	35
Adding new links between existing stack units.....	35
Support for two-unit stack linear-topology trunks.....	36
Building a two-unit linear-topology trunk manually.....	36
Building a two-unit stack with a linear-topology trunk using stack interactive-setup.....	40
Creating a two-unit linear-topology stack using stack zero-touch provisioning.....	42

Changing a live two-unit stack to a linear-topology trunk.....	45
Changing a live linear-topology trunk to a ring.....	46
Building a Stack.....	49
Planning to build a stack.....	49
Software requirements.....	49
Stack requirements.....	49
Ruckus stacking topologies.....	49
FastIron stacking distances and optics by device.....	50
Stacking configuration guidelines.....	54
Planning to build a stack with 802.1br switch port extender capability.....	55
Stack construction methods.....	56
The stack interactive-setup utility.....	56
Scenario 1 - Using stack interactive-setup to create a stack.....	57
Scenario 2 - Using zero-touch provisioning to configure a stack.....	77
Scenario 3 - Manually configuring a three member stack in a ring topology.....	83
Verifying a stack configuration.....	85
Displaying information on stack connections.....	87
Stacking by Device.....	89
ICX 7150 stack configuration overview.....	89
ICX 7150 stacking ports.....	90
ICX 7150 stacking topologies.....	92
ICX 7150 configuration notes.....	95
ICX 7150 stacking trunks.....	96
Converting stacking ports to data ports on ICX 7150 devices.....	101
ICX 7250 stack configuration overview.....	102
ICX 7250 stacking topologies.....	103
ICX 7250 stacking configuration notes.....	105
Reconfiguring ICX 7250 1-Gbps ports as 10-Gbps ports.....	106
ICX 7250 trunk configuration.....	106
ICX 7450 stack configuration overview.....	107
ICX 7450 stacking topologies.....	109
ICX 7450 stacking configuration notes.....	113
Configuring 10-Gbps stacking ports on ICX 7450 devices.....	113
Creating stacking trunks on the ICX 7450.....	115
ICX 7650 stack configuration overview.....	117
ICX 7650 stacking ports.....	118
ICX 7650 stacking topologies.....	119
ICX 7650 configuration notes.....	122
ICX 7650 rear-module options.....	123
Forming an ICX 7650 stack.....	126
ICX 7750 stack configuration overview.....	136
ICX 7750 stacking topologies.....	138
Installing the ICX 7750 in a remote stack.....	143
ICX 7750 stacking configuration notes.....	145
ICX 7750 trunk formation during interactive-setup.....	146
Removing stacking ports from an ICX 7750.....	147
Creating an ICX 7750 stacking link in a production environment.....	147
Converting an ICX 7750 trunk to a port connection in a live stack.....	148
Converting an ICX 7750 ring to a linear stack in a live environment.....	149

Restoring a data port from an ICX 7750 trunk in a live stack.....	150
ICX 7850 stack configuration overview.....	150
ICX 7850 stacking topologies.....	151
ICX 7850 configuration notes.....	154
Creating a two-unit ICX 7850 stack with a linear-topology trunk using stack interactive-setup.....	155
Using stack zero-touch provisioning to create a two-unit ICX 7850 stack with a ring topology.....	158
Creating a linear-topology trunk on a two-unit ICX 7850 stack in a live environment.....	162
Manually creating a two-unit ICX 7850 stack with a ring topology.....	166
Hitless Stacking.....	171
Hitless stacking overview.....	171
Hitless stacking behavior.....	171
Supported hitless stacking events	173
Non-supported hitless stacking events.....	173
Supported hitless stacking protocols and services.....	173
Hitless stacking configuration notes and feature limitations.....	176
What happens during a hitless stacking switchover or failover.....	176
Real-time synchronization among all units in a stack.....	176
Standby controller role in hitless stacking.....	177
Standby controller election.....	177
Runtime configuration mismatch.....	178
Support during stack formation, stack merge, and stack split.....	178
Hitless stacking failover.....	181
Enabling hitless stacking failover.....	181
Hitless stacking failover example.....	182
Hitless stacking switchover.....	182
Executing a hitless stacking switchover.....	183
Hitless stacking switchover examples.....	183
Displaying information about hitless stacking.....	187
Displaying information about stack failover.....	188
Displaying hitless stacking status.....	188
Displaying pending device roles.....	188
Displaying information about link synchronization status.....	188
Syslog messages for hitless stacking failover and switchover.....	189
Stack Management.....	191
Managing a stack through one IP address.....	191
Enabling or disabling stacking mode.....	191
Disabling stacking mode.....	192
Controlling the stack through the CLI.....	192
Logging in through the console port.....	192
CLI command syntax for stack units.....	193
Stack unit identification	193
Naming a stack unit.....	194
Stack management MAC address.....	195
Manually allocating the stack MAC address.....	196
Stack device roles and elections.....	197
Active controller.....	197
Standby controller.....	198
Bootup role.....	198
Active controller and standby controller elections.....	198

Active controller and standby controller resets.....	199
Standby controller selection based on priority configuration.....	200
Standby controller election criteria.....	200
Stack unit priority.....	200
Changing the priority of a stack unit.....	202
Stack software images.....	202
Confirming stack software versions.....	202
Stack mismatches.....	202
Advanced feature privilege mismatch.....	203
Minor mismatch for stack units.....	203
Major mismatch for stack units.....	204
Configuration mismatch for stack units.....	204
Memory allocation failure.....	205
Auto Image Copy for stack units.....	206
Copying the flash image to a stack unit from the active controller.....	207
Configuring stacking trunks in a live environment.....	207
Displaying multi-trunk stacking configuration.....	208
Error messages encountered when configuring a stacking trunk.....	208
Configuring stacking ports in a live environment.....	209
Adding, removing, or replacing units in a stack.....	210
Installing a new unit in a stack using stack interactive-setup.....	210
Removing a unit from a stack.....	210
Stack unit replacement.....	210
Moving a unit to another stack.....	215
Removing an active controller from a powered stack.....	215
Reloading a stack unit.....	215
Managing stack partitioning.....	216
Merging stacks.....	216
Unconfiguring a stack.....	217
Syslog, SNMP, and traps for stack units.....	218
Configuring SNMP for a stack.....	218
SNMP engine IDs for stackable devices.....	218
Displaying stack information.....	219
Displaying stacking topology.....	219
Displaying running configuration information.....	220
Displaying software version information.....	221
Displaying stack flash information.....	223
Displaying stack memory information.....	223
Displaying stack chassis information	224
Displaying stack module information.....	225
Displaying general or detailed information about stack members.....	225
Displaying information about stack neighbors.....	227
Displaying stack port information.....	228
Displaying stacking port statistics.....	228
Displaying stacking port interface information.....	229
Displaying IPC statistics for a stack.....	229
Displaying reliable IPC statistics for stack units.....	231
Displaying information on stack zero-touch configuration.....	233
MIB support for ICX stack configurations.....	235
ICX Stack Troubleshooting.....	237

Problems commonly diagnosed with stack formation.....	237
Manually triggering stack diagnosis.....	237
Troubleshooting an unsuccessful stack build.....	238
Troubleshooting stack interactive-setup.....	240
Troubleshooting unit replacement issues.....	241
Checking hardware after an upgrade failure.....	241
Troubleshooting image copy issues.....	243
Configuration, startup configuration files, and stacking flash.....	243
Stacking unit role transition considerations.....	244
Port down and aging.....	244

Preface

- Document Conventions..... 9
- Command Syntax Conventions..... 10
- Document Feedback..... 10
- Ruckus Product Documentation Resources..... 10
- Online Training Resources..... 11
- Contacting Ruckus Customer Services and Support..... 11

Document Conventions

The following table lists the text conventions that are used throughout this guide.

TABLE 1 Text Conventions

Convention	Description	Example
monospace	Identifies command syntax examples	<code>device(config)# interface ethernet 1/1/6</code>
bold	User interface (UI) components such as screen or page names, keyboard keys, software buttons, and field names	On the Start menu, click All Programs .
<i>italics</i>	Publication titles	Refer to the <i>Ruckus Small Cell Release Notes</i> for more information.

Notes, Cautions, and Warnings

Notes, cautions, and warning statements may be used in this document. They are listed in the order of increasing severity of potential hazards.

NOTE

A NOTE provides a tip, guidance, or advice, emphasizes important information, or provides a reference to related information.

ATTENTION

An ATTENTION statement indicates some information that you must read before continuing with the current action or task.



CAUTION

A CAUTION statement alerts you to situations that can be potentially hazardous to you or cause damage to hardware, firmware, software, or data.



DANGER

A DANGER statement indicates conditions or situations that can be potentially lethal or extremely hazardous to you. Safety labels are also attached directly to products to warn of these conditions or situations.

Command Syntax Conventions

Bold and italic text identify command syntax components. Delimiters and operators define groupings of parameters and their logical relationships.

Convention	Description
bold text	Identifies command names, keywords, and command options.
<i>italic text</i>	Identifies a variable.
[]	Syntax components displayed within square brackets are optional. Default responses to system prompts are enclosed in square brackets.
{ x y z }	A choice of required parameters is enclosed in curly brackets separated by vertical bars. You must select one of the options.
x y	A vertical bar separates mutually exclusive elements.
< >	Nonprinting characters, for example, passwords, are enclosed in angle brackets.
...	Repeat the previous element, for example, <i>member[member...]</i> .
\	Indicates a “soft” line break in command examples. If a backslash separates two lines of a command input, enter the entire command at the prompt without the backslash.

Document Feedback

Ruckus is interested in improving its documentation and welcomes your comments and suggestions.

You can email your comments to Ruckus at ruckus-docs@arris.com.

When contacting us, include the following information:

- Document title and release number
- Document part number (on the cover page)
- Page number (if appropriate)

For example:

- Ruckus SmartZone Upgrade Guide, Release 5.0
- Part number: 800-71850-001 Rev A
- Page 7

Ruckus Product Documentation Resources

Visit the Ruckus website to locate related documentation for your product and additional Ruckus resources.

Release Notes and other user documentation are available at <https://support.ruckuswireless.com/documents>. You can locate the documentation by product or perform a text search. Access to Release Notes requires an active support contract and a Ruckus Support Portal user account. Other technical documentation content is available without logging in to the Ruckus Support Portal.

White papers, data sheets, and other product documentation are available at <https://www.ruckuswireless.com>.

Online Training Resources

To access a variety of online Ruckus training modules, including free introductory courses to wireless networking essentials, site surveys, and Ruckus products, visit the Ruckus Training Portal at <https://training.ruckuswireless.com>.

Contacting Ruckus Customer Services and Support

The Customer Services and Support (CSS) organization is available to provide assistance to customers with active warranties on their Ruckus products, and customers and partners with active support contracts.

For product support information and details on contacting the Support Team, go directly to the Ruckus Support Portal using <https://support.ruckuswireless.com>, or go to <https://www.ruckuswireless.com> and select **Support**.

What Support Do I Need?

Technical issues are usually described in terms of priority (or severity). To determine if you need to call and open a case or access the self-service resources, use the following criteria:

- Priority 1 (P1)—Critical. Network or service is down and business is impacted. No known workaround. Go to the **Open a Case** section.
- Priority 2 (P2)—High. Network or service is impacted, but not down. Business impact may be high. Workaround may be available. Go to the **Open a Case** section.
- Priority 3 (P3)—Medium. Network or service is moderately impacted, but most business remains functional. Go to the **Self-Service Resources** section.
- Priority 4 (P4)—Low. Requests for information, product documentation, or product enhancements. Go to the **Self-Service Resources** section.

Open a Case

When your entire network is down (P1), or severely impacted (P2), call the appropriate telephone number listed below to get help:

- Continental United States: 1-855-782-5871
- Canada: 1-855-782-5871
- Europe, Middle East, Africa, Central and South America, and Asia Pacific, toll-free numbers are available at <https://support.ruckuswireless.com/contact-us> and Live Chat is also available.
- Worldwide toll number for our support organization. Phone charges will apply: +1-650-265-0903

We suggest that you keep a physical note of the appropriate support number in case you have an entire network outage.

Self-Service Resources

The Ruckus Support Portal at <https://support.ruckuswireless.com> offers a number of tools to help you to research and resolve problems with your Ruckus products, including:

- Technical Documentation—<https://support.ruckuswireless.com/documents>

Preface

Contacting Ruckus Customer Services and Support

- Community Forums—<https://forums.ruckuswireless.com/ruckuswireless/categories>
- Knowledge Base Articles—<https://support.ruckuswireless.com/answers>
- Software Downloads and Release Notes—https://support.ruckuswireless.com/#products_grid
- Security Bulletins—<https://support.ruckuswireless.com/security>

Using these resources will help you to resolve some issues, and will provide TAC with additional data from your troubleshooting analysis if you still require assistance through a support case or RMA. If you still require help, open and manage your case at https://support.ruckuswireless.com/case_management.

About This Guide

- Supported hardware..... 13
- What's new in this document..... 13

Supported hardware

This guide supports the following Ruckus products:

- Ruckus ICX 7850 Series
- Ruckus ICX 7750 Series
- Ruckus ICX 7650 Series
- Ruckus ICX 7450 Series
- Ruckus ICX 7250 Series
- Ruckus ICX 7150 Series

For information about what models and modules these devices support, see the hardware installation guide for the specific product family.

What's new in this document

The following tables provide descriptions of new information added to this guide for FastIron software release 08.0.90.

TABLE 2 Summary of enhancements in FastIron release 08.0.90

Feature	Description	Location
ICX 7850 stacking	Stacks of up to 12 ICX 7850 units are supported.	Refer to ICX 7850 stack configuration overview on page 150 for more information.
Configuration and behavior changes, overview	Numerous changes in stacking configuration are introduced in this release. The key changes are itemized in the remainder of this table. The section referenced in the next column provides an overview of the major changes.	Refer to Changes to Stacking in FastIron Release 08.0.90 on page 23 for more information.
Interactive-setup for stacking replaces stack secure-setup	The stack interactive-setup command is introduced to streamline and assist in stack configuration. The stack secure-setup command is deprecated.	Refer to Stack interactive-setup on page 31 for more information.
Zero-touch provisioning for stacking	The stack zero-touch-enable command is introduced to allow automatic stack configuration.	Refer to Stack zero-touch provisioning on page 33 for more information.
Elimination of required default-ports configuration	The default-ports command is deprecated beginning with this release. Configuring stacking ports is simplified.	Refer to No more stack default-ports configuration on page 24 for more information.
Two-unit linear-topology trunks	From this release, two-unit linear-topology trunks are supported on all ICX stackable models. The linear-topology trunk doubles the bandwidth of the stacking ports between two units and provides the same redundancy as a two-unit ring through trunk load balancing.	Refer to Support for two-unit stack linear-topology trunks on page 36 and to the topology section for each ICX model for more information.

TABLE 2 Summary of enhancements in FastIron release 08.0.90 (continued)

Feature	Description	Location
New configuration rules for stacking ports and trunks	Using the stack-port and stack-trunk commands is more intuitive, and some previous restrictions have been eliminated.	Refer to Changes to stack-port and stack-trunk configuration on page 25 for more information.
New downgrade behavior	Stacking port format and configuration change from this release. These changes create upgrade and downgrade issues that require a different strategy. The strategy includes storage of pre-08.0.90 release backup files and the introduction of related commands, show pre-8090-startup-backup and erase pre-8090-startup-backup .	Refer to Upgrade and downgrade changes beginning with FastIron release 08.0.90 on page 29 for more information.
Stacking deployment guidelines	General guidance on stack deployment based on new configuration capabilities has been added to this guide.	Refer to Stacking deployment guidelines on page 34 for more information.
Stack unit location	You can assign a name to a stack unit ID, for example, to indicate the building or rack location.	Refer to Naming a stack unit on page 194 for more information.
New show commands	show stack zero-touch log , show stack zero-touch ipc , show stack zero-touch status , show pre-8090-startup-backup	Refer to the command page for each command in the <i>Ruckus FastIron Command Reference Guide</i> for more information.
New configuration commands	erase pre-8090-startup-backup , stack interactive-setup , stack zero-touch-enable , and unit-name	Refer to related tasks in this guide and to the command page for each command in the <i>Ruckus FastIron Command Reference Guide</i> for more information.

Stacking Overview

- Stacking.....15
- Campus Fabric.....16
- Ruckus stackable models.....18
- Stacking terminology.....19

Stacking

A stack is a group of devices that operate as a single chassis.

A Ruckus stack contains from two to 12 units configured in a ring or linear topology. The units in a stack are from the same model family; that is, a stack can be an ICX 7150 stack, an ICX 7250 stack, an ICX 7450 stack, an ICX 7650 stack, an ICX 7750, or an ICX 7850 stack.

The members of a stack may be located together. For example, Top-of-rack switches can form a stack that acts as a single switch to manage data center access. Stack members can be physically separated, and the distance between stacking members depends on the type of connector cables used.

Certain fiber optic options increase the potential distance between stacks, which allows members of the same stack to reside in different wiring closets, on different floors of one building, or in different buildings across the campus as illustrated in the following figure. Refer to [FastIron stacking distances and optics by device](#) on page 50 for more information.

Ruckus stackable devices are connected either through dedicated stacking ports or through ports that can be configured for either stacking or data. The location of stacking ports and configuration options differ by device type. Refer to the section on each device type for more information.

FIGURE 1 Distributed campus stacking topology

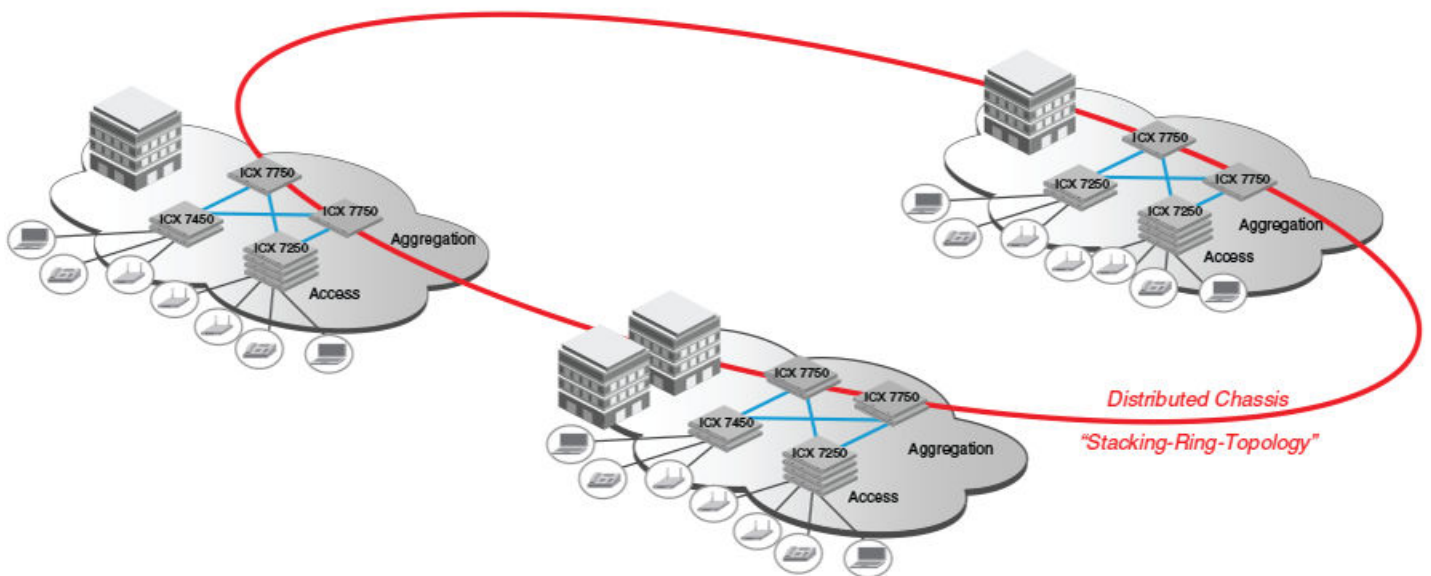

Network management and stack configuration

Even when all the switches within a stack are physically distributed, you can manage them as a single entity, enabling one-touch configuration changes via a single IP address.

The active controller manages the other stack units. It maintains the information database for all stack members and downloads software images as needed to all stack units. Each stack also has a standby controller for stack redundancy, and the stack can fail over seamlessly to the standby.

Configuring the stack through the stack interactive-setup utility is straightforward. Stack zero-touch provisioning can be enabled to automate stack interactive-setup so that no user intervention is required. Custom configuration can be combined with automated setup if, for example, you want to add units, move stacking ports, create trunks, or transform a default stacking port into a data uplink port.

Switching and routing advantages

Packet switching between ports on stack units is handled by the hardware. All protocols operate with stacking in the same way as on a chassis system.

You can use stack connections to link distributed switches instead of standard inter-switch links with Layer 2 Spanning Tree Protocol (STP) or Layer 3 routing. Using stack connections has significant advantages:

- Layer 2 simplicity. Stack links do not need to be considered as part of the overall network topology, which means that they can be used to provide resiliency, and Layer 3 routing is not needed to manage traffic flows.
- No closed links. Because the stack links are internal to the switches, they are not seen as part of a Layer 2 network. This means that all links can remain open and can be used to carry traffic simultaneously, maximizing throughput.
- Fast failover. The rapid detection and recovery techniques used on stack links mean that the failure of a link or a switch results in hitless failover, with no impact on user services.

The next section describes Switch Port Extender technology, which is based on an ICX 7650 or ICX 7750 core stack. Refer to the *Ruckus FastIron Campus Fabric Configuration Guide* for more information.

Campus Fabric

Campus Fabric is sometimes referred to as Switch Port Extender (SPX).

Campus Fabric creates a more scalable architecture based on IEEE 802.1BR standards. Ruckus Campus Fabric architecture adds ICX 7450, ICX 7250, or ICX 7150 devices configured as port extenders (PEs), or PE units, to a set of ICX 7750 or ICX 7650 stack units configured as the control bridge. The ICX 7750 or ICX 7650 control bridge (CB) provides a single point of management for the extended network. Active and standby controller functions are retained and continue to provide hitless recovery as well as extended administrative functions. Campus Fabric greatly increases the number of access devices that the network can support. The distributed CB at the center of Campus Fabric architecture manages PE units and hundreds to thousands of ports at the network edge.

PE units are standards-based devices. Typically lower in cost, PE units rely on the CB for most network functions. As the network expands, new PE units can be detected and added to the network automatically using defined Campus Fabric communication protocols. PE units also inherit Premium-license features from the CB, which further reduces cost.

Campus Fabric architecture simplifies network management by unifying core, aggregation, and access functions. As illustrated in the following figure, a core stack (distributed chassis) serving as the CB connects to downstream Campus Fabric (PE) units that aggregate large numbers of access devices.

FIGURE 2 Campus Fabric domain build-out from an ICX 7750 or ICX 7650 CB stack

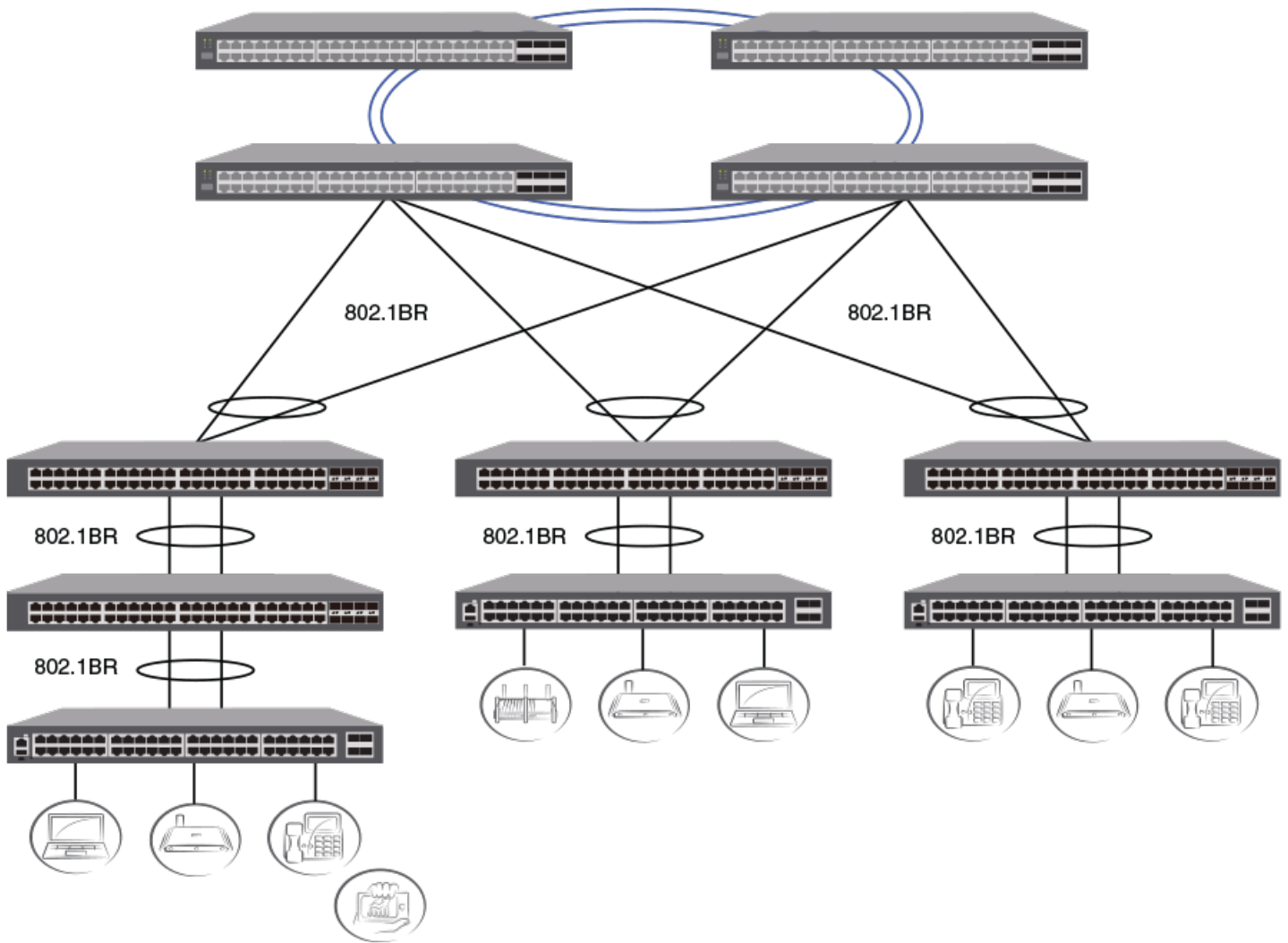

The following figure depicts three separate campuses, each with its own Campus Fabric domain, interconnected with a high-speed backbone.

FIGURE 3 Distributed campus network formed from connected Campus Fabric domains

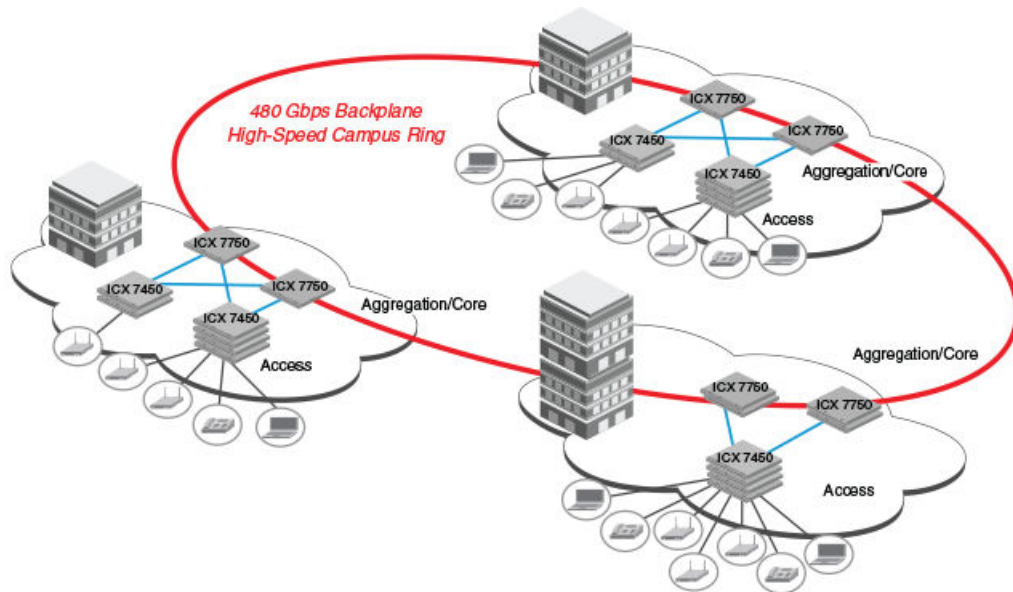

Ruckus stackable models

All ICX 7450, ICX 7650, ICX 7750, and ICX 7850 devices and some ICX 7250 and ICX 7150 devices can be members of a Ruckus ICX stack. ICX 7650 or ICX 7750 devices installed in a stack can also be configured as an 802.1br control bridge that manages ICX 7450, ICX 7250, or ICX 7150 devices configured as port extender (PE) units. Refer to the *Ruckus FastIron Campus Fabric Configuration Guide* for information on 802.1br configuration.

Refer to the following sections for information on ICX 7150 stacking:

- [ICX 7150 stack configuration overview](#) on page 89
- [ICX 7150 stacking topologies](#) on page 92
- [Planning to build a stack with 802.1br switch port extender capability](#) on page 55.

Refer to the following sections for information on ICX 7250 stacking:

- [ICX 7250 stack configuration overview](#) on page 102
- [ICX 7250 stacking topologies](#) on page 103
- [Planning to build a stack with 802.1br switch port extender capability](#) on page 55.

Refer to the following sections for information on ICX 7450 stacking:

- [ICX 7450 stack configuration overview](#) on page 107
- [ICX 7450 stacking topologies](#) on page 109
- [Planning to build a stack with 802.1br switch port extender capability](#) on page 55.

Refer to the following sections for information on ICX 7650 stacking:

- [ICX 7650 stack configuration overview](#) on page 117
- [ICX 7650 stacking topologies](#) on page 119.

Refer to the following sections for information on ICX 7750 stacking:

- [ICX 7750 stack configuration overview](#) on page 136
- [ICX 7750 stacking topologies](#) on page 138
- [Planning to build a stack with 802.1br switch port extender capability](#) on page 55.

Refer to the following sections for information on ICX 7850 stacking:

- [ICX 7850 stack configuration overview](#) on page 150
- [ICX 7850 stacking topologies](#) on page 151

For information about physical installation of each type of device, refer to the appropriate hardware installation guide.

Stacking terminology

Certain terms and roles specific to stacking are used throughout this guide. This section describes the roles stack units may assume as well as terms key to understanding stacking.

NOTE

Refer to the *Ruckus FastIron Campus Fabric Configuration Guide* for terms specific to IEEE 802.1br and switch port extender (SPX) capability.

Stack unit roles

- Active controller: Handles stack management and configures all system- and interface-level features.
- Standby controller: The stack member with the highest priority after the active controller. The standby controller takes over if the current active controller fails.
- Stack member: A unit functioning in the stack in a capacity other than active controller or standby controller.
- Stack unit: Any device functioning within the stack, including the active controller and standby controller.
- Standalone unit: An eligible unit that is not part of a stack that can be interchanged with an active controller without reload. A standalone unit becomes an active controller when any member joins the stack. An active controller becomes a standalone when it loses all stack members.

Stacking terms

- Bootup role: The role a unit takes during the boot sequence. This role can be standalone, active controller, standby controller, stack member, or PE (port extender, in an 802.1br Campus Fabric network).
- Clean unit: A unit that contains no startup flash configuration or runtime configuration. To erase old configuration information, enter the **erase startup-config** command and reset the unit without entering the **write memory** command. If a stack member is without an active controller, you can access its local console and enter the **stack unconfigure clean** command to convert it to a clean unit. Converting a unit to a clean unit does not remove its loaded licenses.

NOTE

An ICX 7650 device with startup-config flash using 40-Gbps stacking ports that has no other configuration is treated as a clean unit. Because an ICX 7650 device that uses 40-Gbps stacking requires the **rear-module stack-40g** command followed by the **write memory** and **reload** commands to change the default 100-Gbps stacking ports to 40-Gbps stacking ports, the related startup-config flash must be present.

- Control path: A path across stacking links dedicated to carrying control traffic such as commands to program hardware or software image data for upgrades. A stack unit must join the control path to operate fully in the stack.
- Default ports: FastIron devices used the default-ports to define stacking port candidates. The **stack default-ports** command is deprecated in Release 08.0.90. However, the default-ports are still used internally to define which ports can be stacking ports. From Release 08.0.90, these ports are often referred to as valid-stack-ports or simply as stack-ports. See also the term *Valid-stack-port set*.
- Direction: Every stack unit has one or two directions for linking to other units. Each direction is either a stack-port or stack-trunk. System output, for example, in show commands, uses "D0" or "dir 0" to indicate the first direction.
- Dynamic configuration: A unit configuration that is dynamically learned by a new stack unit from the active controller. A dynamic configuration disappears when the unit leaves the stack. The configuration becomes a static configuration after you enter the **write memory** command.
- Interprocessor Communications (IPC): The process by which proprietary packets are exchanged between stack unit CPUs.
- IronStack: A set of Ruckus stackable units (maximum of twelve) and their connected stacking links so that all units can be accessed through their common connections. A single unit can manage the entire stack, and configurable entities, such as VLANs and trunk groups, can have members on multiple stack units.
- Linear-topology trunk: A type of trunk available only in a two-unit stack to place stack-ports in both directions into a single trunk. The resulting trunk achieves the same redundancy as a two-unit ring and doubles the bandwidth of the stacking ports. All ports in the linear-topology trunk are used in forwarding between the two units, in contrast to a two-unit ring, which uses only one direction, even when two paths are available. For ICX 7750 devices, a linear-topology trunk may contain ports from two slots, for example, the configuration **stack-trunk x/2/1 to x/2/6 x/3/1 to x/3/6**. This feature is available in FastIron release 08.0.90 and later. Refer to [Support for two-unit stack linear-topology trunks](#) on page 36.
- Non-Functioning stack unit: A stack unit that is recognized as a stack member, and is communicating with the active controller over the Control Path, but is in a non-functioning state. A non-functioning stack unit will drop or discard traffic from non-stacked ports. This may be caused by an image or configuration mismatch.
- Reserved / provisional unit: A unit configuration number that has no physical unit associated with it.
- Sequential connection: Stack unit IDs, beginning with the active controller, are sequential. For example, 1, 3, 4, 6, 7 is sequential if active controller is 1. 1, 7, 6, 4, 3 are non-sequential in a linear topology, but become sequential in a ring topology when counted from the other direction as: 1, 3, 4, 6, 7. Gaps in numbering are allowed.
- Stack interactive-setup: An interactive tool that assists in discovering units and constructing a stacking system. The stack interactive-setup utility can also discover new links between existing stack units, enlarge a stacking trunk, or change a chain topology to a ring. The utility also provides an option for users to change member IDs interactively.

NOTE

Ruckus recommends the use of stack interactive-setup in preference to stack zero-touch provisioning (**stack zero-touch-enable** configuration) because the interactive-setup utility allows you more flexibility when selecting units, assigning, IDs, or configuring a linear-topology trunk. Stack interactive-setup displays warning messages about connection errors, making them easier to spot.

- Stack path: A data path formed across the stacking links to determine the set of stack members that are present in the stack topology, and their locations in the stack.
- Stack slot: A *slot* in a stack is synonymous with a *line model* in a chassis.
- Stack topology: A contiguously-connected set of stack units in an ICX stack that are currently communicating with each other. All units that are present in the stack topology appear in output from the **show stack** command.
- Stacking link: A cable that connects a stacking port on one unit to a stacking port on another unit.

- Stacking port: A physical interface on a stack unit that connects a stacking link. Stacking ports are point-to-point links that exchange proprietary packets. Stacking ports cannot be configured for any other purpose while operating as stacking ports. The number of available stacking ports depends on the platform. Some ports can be configured as either stacking ports or regular data ports. Refer to the hardware installation guide for the specific device for more information.
 - Stack-port: A configuration command used to define a single stacking port in one direction.
 - Stack-trunk: A configuration command used to define multiple stacking ports in one direction. A trunk is also referred to as a link aggregation group (LAG).
- Stack zero-touch provisioning (ZTP): Automatic discovery of stack members when **stack zero-touch-enable** is configured. When stack zero-touch provisioning is enabled, the system performs stack interactive-setup every three minutes in background, without any prompts to the user or opportunities for user input. The resulting configuration is similar to running stack interactive-setup and accepting all suggested values.
- Standalone unit: A unit that is not enabled for stacking, or an active controller without any standby controller or stack members.
- Static configuration: A configuration that remains in the database of the active controller even if the unit it refers to is removed from the stack. Static configurations are derived from the startup configuration file during the boot sequence, are manually entered, or are converted from dynamic configurations after a **write memory** command is issued.
- Trunked stacking port (trunk): A trunk consists of multiple stacking ports and is treated as one logical link. It provides more bandwidth and better resilience than individually connected ports. A trunk is often referred to as a link aggregation group (LAG).
- Unit replacement: The process of swapping out a unit with a clean unit that contains the same modules. Unit replacement is periodically triggered in background and does not require any command entry.
- Valid-stack-port set: A set of stacking ports that must be used to configure stacking. There are two stacking directions, so each valid-stack-port set contains two ports. Each stack direction must start with a specific port in the valid-stack-port set. For example, an ICX 7150-24P device has the valid-stack-port set (x/3/1, x/3/3, 2). In this notation, the "2" indicates that a stack-trunk can have up to two ports. The stack-port configuration must be a valid-stack-port (for an ICX 7150-24P, x/3/1 or x/3/3). A stack-trunk configuration contains contiguous ports starting from a valid-stack-port, for example, for an ICX 7150-28P device, **stack-trunk 1/3/3 to 1/3/4**. A platform may support multiple valid-stack-port sets. Both stacking directions must originate from the same set. For example, an ICX 7250 device has two valid-stack-port sets, (x/2/1, x/2/3, 2) and (x/2/5, x/2/7, 2). When you configure an ICX 7250 for stacking, you cannot configure stack-port 1/2/1 and stack-port 1/2/5 in the same unit. For more information, refer to [Valid-stack-port sets](#) on page 23 and to the stacking overview section for a particular ICX device.

Changes to Stacking in FastIron Release 08.0.90

- Valid-stack-port sets..... 23
- No more stack default-ports configuration..... 24
- Stacking ports displayed even when stacking is not enabled..... 24
- Changes to stack-port and stack-trunk configuration..... 25
- Changes to upgrade and downgrade for stacking from FastIron release 08.0.90..... 29
- Stack interactive-setup..... 31
- Stack zero-touch provisioning..... 33
- Stacking deployment guidelines..... 34
- Support for two-unit stack linear-topology trunks..... 36

Valid-stack-port sets

Ruckus stacking systems support flexible stacking ports. Most platforms allow users to select stacking ports from a list of ports. The ports that are not used as stacking ports can be used as data ports. The stacking port selection cannot be arbitrary. It must follow rules that respect the defined valid-stack-port set (*a/b/c*, *a/b/d*, *n*), where *a/b/c* and *a/b/d* are the starting ports of two directions, and *n* is the maximum number of ports in a stacking trunk. Some platforms support multiple valid-stack-port sets.

Ruckus supports linear or ring topologies. A unit has one direction (in a typical linear topology) or two directions (in a ring). Each direction contains one or multiple stacking ports. The command **stack-port** *unit/slot/port* contains one port, and the command **stack-trunk** *unit/slot/port to unit/slot/port* uses multiple contiguous ports.

In FastIron 08.0.90 or later, you must observe the following rules to configure the **stack-port** or **stack-trunk** command related to the valid-stack-port set.

NOTE

The examples given apply to ICX 7750 devices. Valid-stack-port sets for different ICX models differ and are provided in the stacking overview for each device. Every ICX 7750 device has six valid-stack-port sets. The three most common sets are (*x/2/1*, *x/2/4*, 3), (*x/3/1*, *x/3/4*, 3) and (*x/2/1*, *x/3/1*, 6), where *x* represents a stack ID, and the third number in each set specifies the maximum number of ports in a stacking trunk.

- A stack-port must be a port in the valid-stack-port set. For example, the configuration **stack-port 1/2/4** is allowed, but **stack-port 1/2/2** is not allowed.
- A stack-trunk must contain contiguous ports starting from one port in the valid-stack-port set. For example, the configuration **stack-trunk 1/3/1 to 1/3/5** satisfies the valid-stack-port set (*x/2/1*, *x/3/1*, 6), but the configuration **stack-trunk 1/3/2 to 1/3/4** is invalid.
- The number of ports in a **stack-trunk** configuration cannot exceed the number defined in the valid-stack-port set.
- The **stack-port** and the **stack-trunk** configuration for a unit must originate from the same valid-stack-port set. For example, the configuration **stack-port 1/2/1** and **stack-trunk 1/3/1 to 1/3/6** satisfies the valid-stack-port set (*1/2/1*, *1/3/1*, 6). The configuration **stack-port 1/2/1** and **stack-port 1/3/4** is invalid because the two stacking ports originate in different valid-stack-port sets.
- Adding **stack-port** or **stack-trunk** configuration may cause the removal of existing **stack-port** or **stack-trunk** configuration if the new configuration is not contained in the same valid-stack-port set. For example, suppose a unit configuration contains **stack-port 1/2/1** and **stack-port 1/2/4**. If you configure **stack-port 1/3/1**, the system removes

stack-port 1/2/4 and keeps 1/2/1 because port 1/2/1 and port 1/3/1 satisfy the valid-stack-port set (1/2/1, 1/3/1, 6). If you configure **stack-port 1/3/4**, the system removes both old stack-ports because no valid-stack-port set contains both the ports in the new configuration, 1/2/x and 1/3/4.

- If adding **stack-port** or **stack-trunk** configuration would cause the removal of a live stacking port or stacking trunk, the command entry is denied. For example, suppose a unit has a live link 1/3/1 to another unit. If you were to configure **stack-port 1/2/4**, it would cause the removal of 1/3/1 because the port combination (1/2/4, 1/3/1) is not contained in any valid-stack-port set. In this case, the system prints an error message and denies the configuration as shown in the following example.

```
ICX7750-26Q Router# configure terminal
ICX7750-26Q Router(config)# stack unit 1
ICX7750-26Q Router(config-unit-1)# stack-port 1/2/4
Error! It may break the link 1/3/1 -- 2/3/1.
If the link is not needed, please unplug cables and remove the configuration of both ends.
stack-port 1/2/4 would remove stack-port 1/3/1 to satisfy (1/2/1, 1/2/4, 3).
```

No more stack default-ports configuration

In releases prior to FastIron 08.0.90, users either had to use the factory-set default stacking ports or configure alternative default stacking ports using the **stack default-ports** command; otherwise, the desired stacking ports could not be configured, and the unit could not be discovered by the stack secure-setup utility (replaced by the stack interactive-setup utility in FastIron 08.0.90).

FastIron 08.0.90 eliminates the requirement of configuring default stacking ports. For example, you can link ICX 7750 ports on slot 3 and use the **stack interactive-setup** command to build a stack without any **stack default-ports** configuration. In releases prior to FastIron 08.0.90, users had to configure **stack default-ports 1/3/1 1/3/4** on every ICX 7750 unit that stacked from slot 3 before running the stack secure-setup utility because the factory-set default stacking ports are 1/2/1 and 1/2/4.

Stacking ports displayed even when stacking is not enabled

In FastIron releases prior to 08.0.90, when stacking is not enabled, the system does not display factory-default stacking ports in **show running-config** command output. However, in these releases, if the stacking ports have been changed, they are displayed. In contrast, FastIron release 08.0.90 always displays stacking ports in **show running-config** command output, regardless of whether stacking is enabled or whether the stacking ports are set to factory default or have been changed.

In all FastIron releases, when **stack enable** is not configured, the stacking ports are available for use as data ports and may contain any data port configuration such as tagged ports.

NOTE

FastIron release 08.0.90 corrects the difficulty of configuring stacking ports as breakout ports that was present in previous releases.

NOTE

Beginning with FastIron release 08.0.90, any stacking port can serve as a breakout port as long as the **stack enable** command is not configured. However, the stacking ports are always displayed in three-tuple format (x/y/z) even when they have been configured as breakout ports. For example, if port 1/2/1 is a breakout port, it appears in general configuration or **show** command output as 1/2/1:1; however, any output that shows the port as stack-port configuration displays the port as 1/2/1.

In all releases, when you enter the **stack enable** command, the system checks all stacking ports to make sure they contain no configuration. If any configuration is present, the **stack enable** command is denied.

Changes to stack-port and stack-trunk configuration

Beginning with FastIron 08.0.90, using the **stack-port** and **stack-trunk** commands to configure stacking ports and trunks eliminates the following restrictions that were present in previous configuration methods.

1. A stacking trunk had to be built on top of a stacking port. Without **stack-port** configuration, you could not add **stack-trunk** configuration. Both the **stack-port** and the **stack-trunk** configuration represented the **stack-trunk**.
2. In releases prior to FastIron 08.0.90, the command **no stack-trunk** changed a stacking trunk to its underlying stack-port; it did not remove all ports from the stacking trunk.
3. A **stack-port** configuration could contain one or two stack-ports. If you re-entered the **stack-port** command with only one of the original two ports, the other port was removed.
4. To configure stacking ports or stacking trunks that did not use the factory-set stacking ports, you first had to configure different default ports (choosing from those available) using the **stack default-ports** command.

The following sections provide more detailed comparison of new behavior and old behavior. All examples are based on ICX 7750 ports.

General comparison of the new and old behaviors in configuring stacking ports and trunks

The following table provides a side-by-side comparison of stacking port and stacking trunk configuration basics in FastIron 08.0.90 (New behavior) and prior releases (Old behavior). The new behavior uses one command per stack-port or stack-trunk.

TABLE 3 General comparison of old and new behavior

Objective	New behavior	Old behavior
1 port	stack-port 1/2/1	stack-port 1/2/1
2 ports	stack-port 1/2/1 stack-port 1/2/4	stack-port 1/2/1 1/2/4
1 trunk	stack-trunk 1/2/1 to 1/2/3	stack-port 1/2/1 stack-trunk 1/2/1 to 1/2/3
1 port and 1 trunk	stack-port 1/2/4 stack-trunk 1/2/1 to 1/2/3	stack-port 1/2/1 1/2/4 stack-trunk 1/2/1 to 1/2/3
2 trunks	stack-trunk 1/2/1 to 1/2/3 stack-trunk 1/2/4 to 1/2/5	stack-port 1/2/1 1/2/4 stack-trunk 1/2/1 to 1/2/3 stack-trunk 1/2/4 to 1/2/5

Comparison of configuration changes that use non-factory valid-stack-port sets

The following table provides a side-by-side comparison of new and old configuration command behaviors for stack configurations that use stack-ports other than the factory-set default ports. In the table, an ICX 7750 stack serves as the example, and configuration changes use stack-ports other than the factory-set combination (ports 1/2/1 and 1/2/4). The new behavior does not require you to use the **default-ports** command.

TABLE 4 Comparison of commands that use valid-stack-ports other than the factory-set default stacking ports

Objective	New behavior	Old behavior
1 port	stack-port 1/3/1	default-ports 1/2/1 1/3/1 stack-port 1/3/1
2 ports	stack-port 1/2/1 stack-port 1/3/1	default-ports 1/2/1 1/3/1 stack-port 1/2/1 1/3/1
1 trunk	stack-trunk 1/3/1 to 1/3/3	default-ports 1/2/1 1/3/1 stack-port 1/3/1 stack-trunk 1/3/1 to 1/3/3
1 port and 1 trunk	stack-port 1/2/1 stack-trunk 1/3/1 to 1/3/3	default-ports 1/2/1 1/3/1 stack-port 1/2/1 1/3/1 stack-trunk 1/3/1 to 1/3/3
2 trunks	stack-trunk 1/2/1 to 1/2/3 stack-trunk 1/3/1 to 1/3/3	default-ports 1/2/1 1/3/1 stack-port 1/2/1 1/3/1 stack-trunk 1/2/1 to 1/2/3 stack-trunk 1/3/1 to 1/3/3

Comparison of common configuration procedures using factory-set default stacking ports

The following series of tables provide side-by-side comparisons of new and old configuration behaviors required for standard stack configuration procedures when factory-set default stacking ports are used. The examples reference ICX 7750 stack configuration, for which factory-set default stacking ports are 1/2/1 and 1/2/4.

The old behavior sometimes required multiple commands to add or delete one stack-port or stack-trunk and sometimes needed only one command to add or delete two stack-ports or stack-trunks. In contrast, the new behavior always adds or deletes a stack-port or stack-trunk with one command.

TABLE 5 Removing a stacking port

	New behavior	Old behavior
Initial configuration	stack-port 1/2/1 stack-port 1/2/4	stack-port 1/2/1 1/2/4
Remove stack-port 1/2/1	no stack-port 1/2/1	no stack-port 1/2/1 or stack-port 1/2/4
Final configuration	stack-port 1/2/4	stack-port 1/2/4

TABLE 6 Changing a stacking port to a stacking trunk

	New behavior	Old behavior
Initial configuration	stack-port 1/2/1 stack-port 1/2/4	stack-port 1/2/1 1/2/4
Change stack-port 1/2/4 to stack-trunk 1/2/4 to 1/2/6	stack-trunk 1/2/4 to 1/2/6	stack-trunk 1/2/4 to 1/2/6
Final configuration	stack-port 1/2/1 stack-trunk 1/2/4 to 1/2/6	stack-port 1/2/1 1/2/4 stack-trunk 1/2/4 to 1/2/6

TABLE 7 Changing a stacking trunk to a stacking port

	New behavior	Old behavior
Initial configuration	stack-port 1/2/1 stack-trunk 1/2/4 to 1/2/6	stack-port 1/2/1 1/2/4 stack-trunk 1/2/4 to 1/2/6
Change stack-trunk 1/2/4 to 1/2/6 to stack-port 1/2/4	stack-port 1/2/4	no stack-trunk 1/2/4 to 1/2/6
Final configuration	stack-port 1/2/1 stack-port 1/2/4	stack-port 1/2/1 1/2/4

TABLE 8 Adding a stacking trunk

	New behavior	Old behavior
Initial configuration	stack-port 1/2/1	stack-port 1/2/1
Add stack-trunk 1/2/4 to 1/2/6	stack-trunk 1/2/4 to 1/2/6	stack-port 1/2/1 1/2/4 stack-trunk 1/2/4 to 1/2/6
Final configuration	stack-port 1/2/1 stack-trunk 1/2/4 to 1/2/6	stack-port 1/2/1 1/2/4 stack-trunk 1/2/4 to 1/2/6

NOTE

Adding a stacking trunk with no prior configuration in the old behavior requires two steps. The first **stack-port** command adds a stacking port. The second command, **stack-trunk**, changes the stacking port just added to a stacking trunk.

TABLE 9 Completely removing a stacking trunk

	New behavior	Old behavior
Initial configuration	stack-trunk 1/2/1 to 1/2/3 stack-trunk 1/2/4 to 1/2/6	stack-port 1/2/1 1/2/4 stack-trunk 1/2/1 to 1/2/3 stack-trunk 1/2/4 to 1/2/6
Remove stack-trunk 1/2/1 to 1/2/3	no stack-trunk 1/2/1 to 1/2/3	no stack-trunk 1/2/1 to 1/2/3 no stack-port 1/2/1
Final configuration	stack-trunk 1/2/4 to 1/2/6	stack-port 1/2/4 stack-trunk 1/2/4 to 1/2/6

NOTE

Completely removing a stacking trunk in the old behavior requires two steps. The first command, **no stack-trunk**, changes the trunk to a stacking port. The second command, **no stack-port** is required to remove the trunk completely. Another option is to enter the command **no stack-port 1/2/1**, which removes both the **stack-trunk** and the **stack-port** configuration.

TABLE 10 Changing the sole stacking port or trunk to another stacking port or trunk

	New behavior	Old behavior
Initial configuration	stack-port 1/2/1	stack-port 1/2/1
Change stack-port 1/2/1 to stack-trunk 1/2/4 to 1/2/6	stack-trunk 1/2/4 to 1/2/6 no stack-port 1/2/1	stack-port 1/2/4 stack-trunk 1/2/4 to 1/2/6
Final configuration	stack-trunk 1/2/4 to 1/2/6	stack-port 1/2/4 stack-trunk 1/2/4 to 1/2/6

NOTE

The new behavior must add the new stacking port or trunk before removing the old one because there is only one stack-port or stack-trunk, and there is no common port between the new and the old configuration.

TABLE 11 Removing a stacking trunk to add a new trunk that uses different valid-stack-ports

	New behavior	Old behavior
Initial configuration	stack-trunk 1/2/1 to 1/2/3 stack-trunk 1/2/4 to 1/2/6	stack-port 1/2/1 1/2/4 stack-trunk 1/2/1 to 1/2/3 stack-trunk 1/2/4 to 1/2/6
Change stack-trunk 1/2/4 to 1/2/6 to stack-trunk 1/3/1 to 1/3/6	no stack-trunk 1/2/4 to 1/2/6 stack-trunk 1/3/1 to 1/3/6	default-ports 1/2/1 1/3/1 (also generates stack-port 1/2/1 1/3/1) stack-trunk 1/3/1 to 1/3/6
Final configuration	stack-trunk 1/2/1 to 1/2/3 stack-trunk 1/3/1 to 1/3/6	stack-port 1/2/1 1/3/1 stack-trunk 1/2/1 to 1/2/3 stack-trunk 1/3/1 to 1/3/6

TABLE 12 Changing two stacking ports to ports in a different valid-stack-port set

	New behavior	Old behavior
Initial configuration	stack-port 1/2/1 stack-port 1/2/4	stack-port 1/2/1 1/2/4
change stack-ports to 1/3/1 and 1/3/4	stack-port 1/3/1 stack-port 1/3/4	default-ports 1/3/1 1/3/4 (also generates stack-port 1/3/1 1/3/4)
Final configuration	stack-port 1/3/1 stack-port 1/3/4	stack-port 1/3/1 1/3/4

NOTE

When you add a stack-port or a stack-trunk in a different valid-stack-port set, the system removes the old stack-port or stack-trunk if there is no valid-stack-port set that handles both the old and the new stack-ports or stack-trunks.

Changes to upgrade and downgrade for stacking from FastIron release 08.0.90

The stacking port format is different beginning with FastIron 08.0.90. The change in format creates upgrade and downgrade issues.

Upgrading to FastIron release 08.0.90 from earlier releases

Upgrades from earlier releases to FastIron 08.0.90 are seamless. FastIron 08.0.90 recognizes the old format and parses startup-config flash to convert the configuration to the new format. After upgrade, if you enter the **write memory** command to save the configuration, the new format is stored to startup-config flash.

In the following example, an ICX 7450 stack is upgraded to FastIron 08.0.90 from FastIron 08.0.80 startup-config flash. The user has not yet used the **write memory** command. Output for the **show configuration** command shows that the FastIron 08.0.80 startup-config flash remains in the old format. The command output for the **show running-config** command displays the runtime configuration in the new format.

```
ICX7450-48P Router# show configuration
!
Startup-config data location is flash memory
!
Startup configuration:
!
ver 08.0.80T213 <-- old 08.0.80 release startup-config flash
!
stack unit 1
module 1 icx7450-48p-poe-management-module
module 2 icx7400-xgf-4port-40g-module
module 3 icx7400-qsfp-1port-40g-module
module 4 icx7400-qsfp-1port-40g-module
priority 128
default-ports 1/2/1 1/2/3
stack-trunk 1/2/1 to 1/2/2
stack-trunk 1/2/3 to 1/2/4
stack-port 1/2/1 1/2/3
stack unit 2
module 1 icx7450-48p-poe-management-module
module 2 icx7400-xgf-4port-40g-module
module 3 icx7400-qsfp-1port-40g-module
module 4 icx7400-qsfp-1port-40g-module
priority 128
default-ports 2/2/1 2/2/3
stack-trunk 2/2/1 to 2/2/2
stack-port 2/2/1 2/2/3
stack enable
stack mac 609c.9f2a.97e0
```

```
ICX7450-48P Router# show running-config
Current configuration:
!
ver 08.0.90
!
stack unit 1
module 1 icx7450-48p-poe-management-module
module 2 icx7400-xgf-4port-40g-module
module 3 icx7400-qsfp-1port-40g-module
module 4 icx7400-qsfp-1port-40g-module
priority 128
stack-trunk 1/2/1 to 1/2/2
stack-trunk 1/2/3 to 1/2/4
stack unit 2
module 1 icx7450-48p-poe-management-module
```

Changes to Stacking in FastIron Release 08.0.90

Changes to upgrade and downgrade for stacking from FastIron release 08.0.90

```
module 2 icx7400-xgf-4port-40g-module
module 3 icx7400-qsfp-1port-40g-module
module 4 icx7400-qsfp-1port-40g-module
priority 128
stack-trunk 2/2/1 to 2/2/2
stack-port 2/2/3
stack enable
stack mac 609c.9f2a.97e0
```

Downgrading from FastIron 08.0.90 to earlier releases

A standalone or active controller parses the startup-config flash to read the stacking ports for the entire stack. A release prior to FastIron 08.0.90 does not understand startup-config flash content generated by FastIron 08.0.90 or later releases. As a result, if you try to downgrade from FastIron 08.0.90 or later to a pre-08.0.90 release, the stack may break. FastIron 08.0.90 attempts to overcome the need to downgrade by saving and recovering the original startup-config flash.

In FastIron 08.0.90, when the **write memory** command is used, the system renames the startup-config flash "pre-8090-startup-backup" if it has been generated from a pre-08.0.90 release. You can view the contents of the saved file using the **show pre-8090-startup-backup** command.

NOTE

When a stack downgrades to a pre-08.0.90 release from recovered pre-08.0.90 startup-config flash, it loses all configuration changes made under FastIron 08.0.90.

Every unit, including a stack member, has a startup-config file, and every unit renames the startup-config as the backup file when the **write memory** command is used.

If you no longer need the pre-8090-startup-backup file, you can delete it using the **erase pre-8090-startup-backup** command. This command erases the pre-8090-startup-backup file in every unit in the stacking system. You may no longer need the older backup file if you are certain you will not have to downgrade the system or if you have made many configuration changes with the FastIron 08.0.90 or later release installed, making the backup file obsolete.

When a system running FastIron 08.0.90 detects that it is about to reload to a pre-08.0.90 release, the system tries to recover the backup file. A message is displayed asking for confirmation before recovering the file with a warning that all changes made with the current release will be lost.

```
ICX7450-48P Router# boot system flash secondary
Are you sure? (enter 'y' or 'n'): y
Warning! the startup-config is 8.0.90 or later, but you are reloading to a pre-8090 image.
The system will use the pre-8090-startup-backup file to reload and lose all 8.0.90 changes.
(You can type "show pre-8090-startup-backup" to see its content.)
Do you want to reload ? (enter 'y' or 'n'): y
Reload using pre-8090-startup-backup file.
```

NOTE

In contrast, the **reload yes** and **boot system flash secondary yes** commands do not require confirmation. The following example shows the system response when the **boot system flash secondary yes** command is entered.

```
ICX7450-48P Router# boot system flash secondary yes
Reload using pre-8090-startup-backup file.
T=8m11.3: Halt and reboot
```

When a system is upgraded to FastIron 08.0.90 or later and then downgraded to a pre-08.0.90 release, the results of the downgrade differ, depending on the situation. The following cases describe specific situations and the expected results. The scenarios in the following tables apply to a standalone unit or a stack.

TABLE 13 Downgrade scenarios

Situation	Result
The user never uses a write memory command when running FastIron 08.0.90.	The downgrade is seamless.
The user does not change any configuration but uses the write memory command when running FastIron 08.0.90.	The downgrade is fine. The system recovers the backup file before reloading to a pre-08.0.90 release.
The user makes configuration changes while running FastIron 08.0.90 and uses the write memory command.	The downgrade loses all configuration changes made under FastIron 08.0.90. The system recovers the backup file that does not contain the changes.

Switchover or failover does not affect these downgrade scenarios. For example, you may perform a switch-over to change the active controller and then reload. The recovery result is the same as a reload without changing the active controller.

There are a few cases where recovery does not work.

TABLE 14 Scenarios where downgrades cannot be performed

Situation	Result
The user reloads the system by powering down.	The system cannot recover the backup file before reloading.
The standalone or active controller does not have a startup-config flash file generated by any pre-08.0.90 release.	Downgrade is not possible.

NOTE

It is recommended that you copy the running configuration to a file before downgrading. You can do this using the **copy running-config** command to copy the configuration to different locations such as a USB disk file or a tftp server, or you can simply enter the **show running-config** command and then copy the output and paste it into a computer file.

NOTE

If you don't have a pre-08090-startup-backup file (which can be checked with the **show pre-8090-startup-backup** command), or you have many configuration changes to the 08.0.90 release or a later release and you need to downgrade to a pre-08.0.90 release, you must manually edit the 08.0.90 configuration to create a pre-08.0.90 format.

Stack interactive-setup

Stack interactive-setup is the recommended method for constructing a stack. The utility allows you to select units, IDs, and two-unit linear-topology trunks. Stack interactive-setup replaces the stack secure-setup utility used in releases prior to FastIron 08.0.90. The **stack interactive-setup** command, entered in privileged EXEC mode, is used to initiate the utility and is available on a standalone unit or on the active controller of a stack.

Stack interactive-setup has the following capabilities:

- Changing the ID for any existing unit, except for the active controller.

NOTE

Changing an ID does not result in a configuration change. For example, when users change a unit ID from 2 to 3, the system does not change any unit 2 configuration to unit 3 configuration.

- Discovering new links between existing units and enlarging the stacking port or stacking trunk. Stack interactive-setup can discover new links between two end-units of a linear topology and convert the topology to a ring.
- Discovering clean units and converting them to stack members.
- Discovering existing standalone units and converting them to stack members.

NOTE

If a discovered standalone unit is password protected, stack interactive-setup prompts you to enter the password. Stack interactive-setup checks for **enable super-user password** and ignores all other passwords.

Ruckus recommends that you make all physical connections and run **stack interactive-setup** on the active controller of a stack or on a standalone unit that will become the active controller.

In a two-unit stack, you can choose a ring or a chain that forms a linear-topology trunk in either of the following cases:

- The configuration of the active controller is a linear-topology trunk. For example, an ICX 7250 has **stack-trunk 1/2/1 to 1/2/4** or **stack-trunk 1/2/5 to 1/2/8** configuration.
- All linear-topology trunk ports have physical connections.

Refer to [Support for two-unit stack linear-topology trunks](#) on page 36 for more information.

For example, if you connect all four ports 1/2/5 through 1/2/8 to ports 1/2/5 through 1/2/8 on another unit, stack interactive-setup displays an option to choose a ring of two trunks (stack-trunk 1/2/5 to 1/2/6 and stack-trunk 1/2/7 to 1/2/8), or a linear-topology trunk (stack-trunk 1/2/5 to 1/2/8). The default is to form a ring.

The following restrictions apply to connections for both stack interactive-setup and stack zero-touch provisioning:

- The connection cannot be out of sequential order in a stacking trunk. Suppose, for example an ICX 7750 has the connection stack-trunk 1/2/1 to 1/2/3 that links to stack-trunk 2/2/4 to 2/2/6 on stack unit 2. Port 1/2/1 must link to 2/2/4, port 1/2/2 must link to 2/2/5, and so on.
- The primary port must be connected. For example, link 1/2/2 to 2/2/5 without link 1/2/1 to 2/2/4 is not valid. The system displays an error message and aborts.

The system performs numerous checks to confirm that the discovered topology is supported. If the system detects any error, it displays a message and aborts the operation.

The stack interactive-setup utility includes the following behaviors to improve the configuration process:

- The utility sends out probes to discover new units and connections as soon as it is enabled.
- The system changes configuration to suit the discovered topology. For example, if ICX 7750 stacking ports are configured on module 2 and another unit is discovered through ports on module 3, the system changes the ICX 7750 stacking port or stacking trunk configuration to module 3.
- The system tries to consider the current configuration when assigning stacking ports. For example, if the system discovers that ports 1/2/1 and 1/2/2 link to a new unit and the current configuration is stack-port 1/2/1, it enlarges the configuration to include port 1/2/2 and changes it to stack-trunk 1/2/1 to 1/2/2. If the current configuration is stack-trunk 1/2/1 to 1/2/3, the system keeps the super set.
- The stack-trunk is contiguous. If ports 1/2/1 and 1/2/3 link to another unit, the system generates stack-trunk 1/2/1 to 1/2/3, even if 1/2/2 has no link.
- After successfully converting standalone units to stack members, the priority of the unit running the stack interactive-setup utility is raised to 128.

If stack interactive-setup detects new links between existing units and discovers new units, the utility handles only the new links. Then stack interactive-setup requests that you run the utility again to discover new units.

For more information, refer to [The stack interactive-setup utility](#) on page 56.

Differences in stack unit replacement

Stack unit replacement is handled differently beginning with release 08.0.90. The following table compares stack unit replacement in release 08.0.90 and earlier releases.

NOTE

Unit replacement cannot be performed when stack zero-touch provisioning is enabled. Stack zero-touch provisioning is a superset of unit replacement and can handle single or multiple unit replacements.

NOTE

If the unit replacement process cannot handle particular cases due to ambiguity, Ruckus recommends using stack interactive-setup.

Capability	Releases prior to 08.0.90	Release 08.0.90 and later
Replace multiple stack units simultaneously	Yes	No
Handle any setup	No ¹	Yes
Replace a unit when one provisional configuration matches the replacement	Yes	Yes
Replace a unit when multiple provisional configurations match the replacement	Yes ²	No
Replace a unit when no provisional configuration matches the replacement	No	No

Refer to [Stack unit replacement](#) on page 210 for more information.

Stack zero-touch provisioning

Stack zero-touch provisioning is a subset of the stack interactive-setup utility without any user interaction. Stack zero-touch provisioning can detect new links between existing units and can discover new clean units (without startup-config flash), but it cannot change existing unit IDs. Stack zero-touch provisioning is similar to running stack interactive-setup option 2 and accepting all recommended values.

Stack zero-touch provisioning is enabled by entering **stack zero-touch-enable** in global configuration mode. It is triggered every three minutes in background.

Ruckus recommends that you make all physical connections and then configure **stack zero-touch-enable**. Wait for a few minutes for zero-touch provisioning to trigger and discover new units or new links.

NOTE

When enabled, stack zero-touch provisioning is triggered every three minutes; however, if a member is in the process of joining or has joined the stack within the last 90 seconds, discovery is postponed for 30 seconds to allow a minimum pause of 90 seconds after the last join.

After all new units join and all new links appear in **show running-config** command output, it is better to disable stack zero-touch provisioning using the **no stack zero-touch-enable** command. Leaving stack zero-touch provisioning enabled is harmless; however, the utility sends probes in background every three minutes, which wastes resources if there are no more units or links to discover. (In contrast, stack interactive-setup immediately sends out probes when you run it.)

¹ Unit connection must be sequential, for example, 2-4-5-7-8, or 9-7-5-4.
² The assigned ID may be wrong, due to ambiguity.

Stacking deployment guidelines

This section provides guidance for constructing a new stack, adding new members, replacing members, or adding new links within a stack. These tasks can be performed in several different ways. This section describes the most common methods. Other methods are discussed in more detail in later sections.

NOTE

Adding new units or new links without spanning tree protocols (STP) may create loops. Loops cause high traffic in the affected ports and may cause high CPU usage if the looped packets are trapped to the CPU. As a result, failure to enable STP in a stack may have significant impact on traffic in a production environment. STP is enabled by default in switch images. It is not enabled by default in router images.

NOTE

ICX 7150 and ICX 7250 devices must pre-load licenses to enable 10-Gbps stacking ports that allow a unit to join a stack. Refer to the *Ruckus FastIron Software Licensing Guide* for details on ICX licenses.

Constructing a new stack from scratch or adding new units to a stack

Consider the following points when creating a new stack or adding new units to an existing stack.

- The easiest way to create a stack or to add units to a stack is to use the stack interactive-setup utility. The **stack interactive-setup** command provides two options. Option 2 is used to discover clean units. Option 3 can discover clean or non-clean units. For a definition of "clean unit," refer to [Stacking terminology](#) on page 19.
- If you are configuring a stack in a production system, Ruckus recommends configuring spanning tree protocols (STP, RSTP or MSTP) on the active controller before making connections. You can enable either global STP or STP only on the default VLAN. If there are already loops in the system before you configure STP and if the looping packets have higher priority than the STP BPDU packets, STP may not converge. In this case, disable or disconnect the looping links to break the loops so that STP can converge. Then reenable or reconnect the links.
- If you are configuring a stack in a non-production system and you don't want to configure STP, the stack interactive-setup or stack zero-touch provisioning utility can discover new clean units under looping conditions.
- Make all connections before entering the **stack interactive-setup** command.
- Ruckus recommends using stack interactive-setup option 2 to discover clean units.
- When a clean unit receives stack interactive-setup or stack zero-touch provisioning probes, it temporarily installs a filter to drop all traffic except protocol packets on every port to break possible loops in case STP is not enabled. As a result, a clean unit can be discovered by stack interactive-setup or stack zero-touch provisioning under looping conditions. The temporary filter exists only during the stack interactive-setup or stack zero-touch provisioning process. Once the process is completed, loops may recur if STP is not configured.
- Stack interactive-setup option 2 and stack zero-touch provisioning cannot detect non-clean units. Only stack interactive-setup option 3 can detect non-clean unit. However, option 3 may fail under looping condition.
- All loops disappear after the new units are discovered and reload to join the stack. The connected ports become stack-ports or stack-trunks.
- Be sure to enter the **write memory** command after new units join as stack members.

Replacing stack units

Consider the following points when replacing stack members.

- To replace a unit with a clean unit containing the same modules, simply disconnect the old unit and replace it with a clean unit using the same links. The new unit will be discovered in less than two minutes. No command is needed on the active controller or the clean unit.
- A non-clean unit cannot be discovered by the unit replacement feature. It logs and prints a message when it receives unit replacement probing packets. To convert a unit to a clean unit so it can be discovered by stack zero-touch provisioning or stack interactive-setup, enter the **erase startup-config** command on the unit followed by the **reload** command without entering the **write memory** command.
- Replacing a unit does not cause loops, even when STP is not configured. The reason is that replacing a unit uses the same links that are already configured as stack-ports or stack-trunks.
- If the stack is a ring topology, replacing a unit does not break the stack. The stack becomes linear until the new unit joins to form a ring. If the stack is a linear topology, only the edge unit can be replaced. Replacing a non-edge unit in a linear stack causes other units behind it to become unreachable. The unit replacement could fail because the loss of multiple units causes ambiguity.
- To replace multiple units at the same time, first replace all units and make all physical connections before entering the **stack interactive-setup** command.

Adding new links between existing stack units

Adding new links between existing units causes loops if STP is not configured. Any link, excluding stacking ports, between two units in the stack causes loops.

Use one of the following methods to add links successfully between existing stack units.

1. Configure STP and run the stack interactive-setup utility.
 - a. Configure spanning tree protocols (for example, STP, RSTP, MSTP, and PVST) on the active controller before making connections. You can enable either global STP or STP only on the default VLAN. If there are already loops before STP is configured and if the looping packets have higher priority than the STP BPDU packets, STP may not converge. In this case, disable or disconnect the looping links to break loops and allow STP to converge. Then reenabling or reconnecting the links. For example, suppose a link from data port 1/2/4 to 2/2/4 creates a loop. You can configure **disable** under **interface ethernet 1/2/4** to break the loop. Then configure **enable** after STP converges.
 - b. Make all new physical connections.
 - c. Wait for STP to converge before entering the **stack interactive-setup** command. When STP converges, it places some looping ports in the BLOCKING state.
 - d. Run the stack interactive-setup utility. Either option 2 or 3 can discover new links within the stack and configure proper stack-ports or stack-trunks. A linear stack may become a ring. The utility can discover multiple sets of links between unit pairs. For example, it can convert a linear stack to a ring and discover the links among units in one run.
 - e. Be sure to enter the **write memory** command if the system prompts you with a "write memory" message.
2. Use **stack-port**, **stack-trunk**, **multi-stack-port**, or **multi-stack-trunk** commands to create links.
 - a. This approach does not require configuring STP.
 - b. Configure the **stack-port** or **stack-trunk** command on both edge units to change a linear stack to a ring. Then add new links to connect both edge units.

- c. To enlarge the connections between two units, configure the **multi-stack-trunk** command to change both ends of a live link at the same time. Then connect the new links. The links won't cause loops because they have proper stack-trunk configuration.
- d. To reduce the live connections between two units, physically remove the unwanted cables first. Then configure the **multi-stack-port** or **multi-stack-trunk** command to change both ends of the live link at the same time. For example, suppose you have an ICX 7750 stack with a live link stack-trunk 1/2/1 to 1/2/3 connected to stack-trunk 2/2/4 to 2/2/6. After removing the unwanted cables between ports 1/2/3 to 2/2/6 and/or between ports 1/2/2 to 2/2/5, you can enter the command **multi-stack-port 1/2/1 and 2/2/4** or the command **multi-stack-trunk 1/2/1 to 1/2/2 and 2/2/4 to 2/2/5** to reduce the number of ports in the live link.
- e. Changing stacking ports to data ports may cause loops. It is better to disconnect the unwanted cables before reducing live connections as explained in the previous point. The other option is to reduce live connections and then disable the data ports after reducing live connections using the **disable port-number** command in interface configuration mode.

Support for two-unit stack linear-topology trunks

FastIron 08.0.90 and later releases support a linear-topology trunk in a two-unit stack. A two-unit stack can form a linear-topology trunk containing all stacking ports, instead of dividing the ports into the two directions of a ring topology. The linear-topology trunk provides the same redundancy as a two-unit ring because of trunk load balancing. Furthermore, a linear-topology trunk doubles the bandwidth of the stacking ports between two units.

In a two-unit ring topology, only one direction is used even though there are two paths for a unit to reach the other unit. In contrast, a linear-topology trunk uses all ports to reach the other unit.

NOTE

In a ring of more than two units, all directions of any unit are fully utilized because each direction is to a different unit. Therefore, the linear-topology trunk is not supported in a stack of more than two units.

NOTE

A linear-topology trunk cannot co-exist with another stack-port or stack-trunk in the same unit. Therefore, if you configure a linear-topology trunk, the original stack-port or stack-trunk configuration is removed. If a unit has a linear-topology trunk and you configure a stack-port or stack-trunk, the linear-topology trunk is removed.

Building a two-unit linear-topology trunk manually

The following procedure uses an ICX 7250 stack as an example. A two-unit ICX 7250 stack has two potential linear-topology trunks, (x/2/1 to x/2/4) and (x/2/5 to x/2/8). The following figure shows the appropriate cabling for the four-port linear topology trunk (x/2/1 to x/2/4) on an ICX 7250 two-unit stack configured in the following procedure.

FIGURE 4 ICX 7250-24P two-unit stack with linear-topology trunk as configured in example

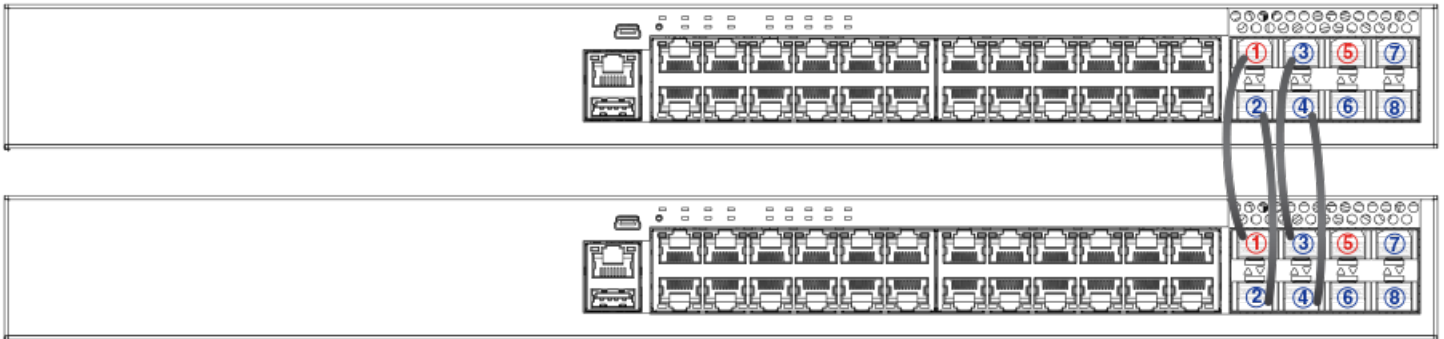

NOTE

If you configure an ICX 7750 two-unit stack, you would have the choice of two linear-topology trunks. You can configure **stack-trunk 1/2/1 to 1/2/6 1/3/1 to 1/3/6** or **stack-trunk 1/2/5 to 1/2/6 1/3/5 to 1/3/6**. Both trunks contain ports in two slots.

Complete the following steps to configure a two-unit linear-topology trunk manually (in this case, on an ICX 7250 two-unit stack).

1. On both units, create the desired trunk in stack unit configuration sub-mode.

```
ICX7250# configure terminal
ICX7250(config)# stack unit 1
ICX7250(config-unit-1)# stack-trunk 1/2/1 to 1/2/4
```

The example configures ports 1/2/1 through 1/2/4 as a stacking trunk on one of the stack unit candidates. Enter the trunk configuration on the other unit, too.

2. Enter the **stack enable** command on both units.

```
ICX7250(config-unit-1)# exit
ICX7250(config)# stack enable
```

3. Connect cables between the two units. (For this example, connect four cables.)

Once connected, both units perform elections to choose the active controller. The unit that loses the election is reloaded as a stack member and later is assigned the standby role.

When the member boots up, it joins, and a two-unit stack forms.

4. Enter the **write memory** command to save the learned configuration.

```
ICX7250(config)# write memory
```

Changes to Stacking in FastIron Release 08.0.90

Support for two-unit stack linear-topology trunks

The following example shows the manual formation of a two-unit ICX 7250 linear-topology stack.

```
====Unit 1 Log====
ICX7250-48P Router# configure terminal
ICX7250-48P Router(config)# stack unit 1
ICX7250-48P Router(config-unit-1)# stack-trunk 1/2/1 to 1/2/4
stack-trunk 1/2/1 to 1/2/4 replaces stack-port 1/2/1 and stack-port 1/2/3
ICX7250-48P Router(config-unit-1)# stack enable
Enable stacking. This unit actively participates in stacking
ICX7250-48P Router(config-unit-1)# end

ICX7250-48P Router# show running-config
Current configuration:
!
ver 08.0.90
!
stack unit 1
  module 1 icx7250-48p-poe-port-management-module
  module 2 icx7250-sfp-plus-8port-80g-module
  stack-trunk 1/2/1 to 1/2/4

stack enable
stack mac 609c.9f99.1988
!
!
hitless-failover enable
!
!
end

ICX7250-48P Router#
T=2m20.4: Election, was alone --> active, ID=1, pri=0, 2U(1-2), A=u1, nbr#=1 0, reason: u2: hitle-fail-
en, ,
T=2m23.0: Election, was active, no change, ID=1, pri=0, 2U(1-2), A=u1, nbr#=1 0, reason: u1: stk-po-chg, ,
T=2m25.9: reset unit 2: u2 bootup-id=1

Config changed due to add/del units. Do write mem if you want to keep it
T=2m31.0: Unit 1 loses all neighbors.
T=2m31.0: Active U1 deletes U2 and its config because it is learned.

====unit 2 log====
ICX7250-48P Router# configure terminal
ICX7250-48P Router(config)# stack unit 1
ICX7250-48P Router(config-unit-1)# stack-trunk 1/2/1 to 1/2/4
stack-trunk 1/2/1 to 1/2/4 replaces stack-port 1/2/1
ICX7250-48P Router(config-unit-1)# stack enable
Enable stacking. This unit actively participates in stacking
ICX7250-48P Router(config-unit-1)# end

ICX7250-48P Router# show running-config
Current configuration:
!
ver 08.0.90
!
stack unit 1
  module 1 icx7250-48p-poe-port-management-module
  module 2 icx7250-sfp-plus-8port-80g-module
  stack-trunk 1/2/1 to 1/2/4

stack enable
stack mac 609c.9f99.3f80
!
!
hitless-failover enable
!
!
end

ICX7250-48P Router#
T=2m23.4: Election, was alone --> member, ID=2, pri=0, 2U(1-2), A=u1, nbr#=1 0, reason: u1: hitle-fail-
```

```
en, ,
My assigned ID is 2, but my bootup ID is 1, need reload
T=2m29.1: Boot request from u1 mac=609c.9f99.1988, reason: u2 bootup-id=1, flash: Primary, jumbo=0,
Unmounting the External USB
We are in system reset

#### Bootup Printout is snipped

The system : started=warm start   reloaded=by "reload"
My stack unit ID = 2, bootup role = member

[MEMBER]local-2@ICX7250-48P Router>
Creating certificate, please wait...

SSL Client Certificate is successfully created

[MEMBER]local-2@ICX7250-48P Router>

T=45.5: Election, was member, no change, ID=2, pri=0, 2U(1-2), A=u1, nbr#=1 0, reason: u1: nbr-no-stk-p, ,
Unit 2 becomes ready
Connecting to active controller 1 console...(Press Ctrl Shift - x to exit)
T=48.5: Election, was member, no change, ID=2, pri=0, 2U(1-2), A=u1, nbr#=1 0, reason: u1: stk-po-chg, ,
ICX7250-48P Router>UNIT2:T=1m49.8: Unit 2 is assigned standby by active u1.
T=1m52.0: Standby u2 start parsing running config from active controller u1
T=1m52.3: Standby u2 finished parsing running config from active controller u1.
T:1m54.5: Done hot swap: standby controller u2 sets u1 to Ready.

ICX7250-48P Router# show running-config
Current configuration:
!
ver 08.0.90
!
stack unit 1
  module 1 icx7250-48p-poe-port-management-module
  module 2 icx7250-sfp-plus-8port-80g-module
  stack-trunk 1/2/1 to 1/2/4

stack unit 2
  module 1 icx7250-48p-poe-port-management-module
  module 2 icx7250-sfp-plus-8port-80g-module
  stack-trunk 2/2/1 to 2/2/4

stack enable
stack mac 609c.9f99.1988
!
!
ICX7250-48P Router# show stack
T=38m56.4: alone: standalone, D: dynamic cfg, S: static
ID  Type      Role      Mac Address      Pri State  Comment
1   S ICX7250-48P  active  609c.9f99.1988   0 local  Ready
2   D ICX7250-48P  standby 609c.9f99.3f80   0 remote Ready

      standby      active
      +----+      +----+
      | 2 |2/1==2/1| 1 |
      +----+      +----+
Standby u2 - protocols ready, can failover or manually switch over
Role history: N: standalone, A: active, S: standby, M: member
U1: N->A

Current stack management MAC is 609c.9f99.1988
ICX7250-48P Router# write memory
```

Building a two-unit stack with a linear-topology trunk using stack interactive-setup

The interactive-setup utility generates the linear-topology trunk option only when either of the following conditions is met:

- All ports of the linear-topology trunk are connected.
- The active controller has a linear-topology trunk configuration.

The following procedure uses an ICX 7250 stack as an example. A two-unit ICX 7250 stack has two potential linear-topology trunks, (x/2/1 to x/2/4) and (x/2/5 to x/2/8).

Complete the following steps to configure a two-unit linear-topology trunk using stack interactive-setup.

1. Connect cables between the two units. (In this example, four cables are used as shown in [Figure 4](#) on page 37.)
2. On the unit you want to become the active controller, enable stacking.

```
ICX7250# configure terminal
ICX7250(config)# stack enable
ICX7250(config)# exit
```

3. On the same unit, run the stack interactive-setup utility.

NOTE

For more information on the stack interactive-setup utility, refer to [The stack interactive-setup utility](#) on page 56.

```
ICX7250# stack interactive-setup
You can abort stack interactive-setup at any stage by <ctrl-c>
0: quit
1: change stack unit IDs
2: discover and convert new units (no startup-config flash) to members
3: discover and convert existing/new standalone units to members
2&3 can also find new links and auto-trunk or convert chain(s) to ring.
Please type your selection: 2
```

The system detects that all ports of a candidate linear-topology trunk are connected. Then it displays an option for you to choose a ring (**y**) or a linear -topology trunk (**n**).

4. When prompted by the system, enter **n** to create a linear-topology trunk.

The unit running stack interactive-setup reloads the other unit as a stack member.

A two-unit stack forms when the member boots up and joins the stack.

5. Enter the **write memory** command to save the learned configuration.

```
ICX7250# write memory
```

The following example shows the creation of a two-unit ICX 7250 stack with a linear-topology trunk using stack interactive-setup.

```
ICX7250-48P Router> en
No password has been assigned yet...
ICX7250-48P Router# show running-config
Current configuration:
!
ver 08.0.90
!
stack unit 1
  module 1 icx7250-48p-poe-port-management-module
  module 2 icx7250-sfp-plus-8port-80g-module
  stack-port 1/2/1
  stack-port 1/2/3
!
!
end

ICX7250-48P Router# stack interactive-setup
You can abort stack interactive-setup at any stage by <ctrl-c>
0: quit
1: change stack unit IDs
2: discover and convert new units (no startup-config flash) to members
3: discover and convert existing/new standalone units to members
2&3 can also find new links and auto-trunk or convert chain(s) to ring.
Please type your selection: 2
Sending probes to ports: u1: 1/2/1 to 1/2/8,
Existing stack: =====
      +----+
      2/1| 1 |2/3
      +----+
```

Horizontal bars link to discovered units. Vertical bars link to stack units.

```
Chain #0: =====
#1: icx7250-48p-poe-port-management 609c.9f99.1988

      1/2/1
      ||
      ||
      2/1
      +----+
      |#1 |
      +----+
```

```
Discovered 1 chain/ring
Chain #0: Do you want to select this chain? (enter 'y' or 'n'): y
#1: icx7250-48p-poe-port 609c.9f99.1988, type an ID (No: 0, default: 2):
```

You selected 1 unit(s): #1: ID=2,

Links U1--U2, #=4: 2/1--2/1, 2/2--2/2, 2/3--2/3, 2/4--2/4,

There are total two units. The connections qualify a linear-topo that puts all discovered links to a trunk. Do you want a ring? (y: ring, n: linear-topo chain) (enter 'y' or 'n'): n

```
          #1
      +----+   +----+
      | 1 |2/1==2/1| 2 |
      +----+   +----+
```

Proceeding will produce the above topology. Do you accept it? (enter 'y' or 'n'): y
stack interactive-setup discovers 1 unit(s) and sends stack-port/trunk to chain 0: linear-topo: 2/1 to 2/4

stack-trunk 1/2/1 to 1/2/4 replaces stack-port 1/2/1 and stack-port 1/2/3

Configuration changed. Please do "write memory".

Changes to Stacking in FastIron Release 08.0.90

Support for two-unit stack linear-topology trunks

```
ICX7250-48P Router#
```

The other units reloads, becomes a member, and joins the stack.

```
T=6m9.2: Election, was alone --> active, ID=1, pri=128, 2U(1-2), A=u1, nbr#=1 0, reason: u2: enable, ,
T:6m11.3: Done hot swap: active controller u1 sets u2 to Ready.
T=6m12.0: Election, was active, no change, ID=1, pri=128, 2U(1-2), A=u1, nbr#=1 0, reason: u1: stk-po-
chg, ,
Config changed due to add/del units. Do write mem if you want to keep it
T=7m12.7: Assigned unit 2 to be standby
ICX7250-48P Router# write memory
```

```
There is no startup config file, unable to save legacy config
```

```
Automatic copy to member units: 2
Flash Memory Write (8192 bytes per dot)
.
Copy Done.
ICX7250-48P Router#
```

```
====Unit 2 Log====
ICX7250-48P Router#Unit 1 receives stack interactive-setup from U1, mac=609c.9f99.3f80
ID=2 D0=2/1 to 2/4, , will reload from Primary in 20 sec
Unmounting the External USB
We are in system reset
```

```
### Bootup printout is snipped
```

```
The system : started=warm start   reloaded=by "reload"
My stack unit ID = 2, bootup role = member
```

```
[MEMBER]local-2@ICX7250-48P Router>
Creating certificate, please wait...
```

```
SSL Client Certificate is successfully created
```

```
[MEMBER]local-2@ICX7250-48P Router>
```

```
T=48.5: Election, was member, no change, ID=2, pri=0, 2U(1-2), A=u1, nbr#=1 0, reason: u1: stk-po-chg, ,
Unit 2 becomes ready
Connecting to active controller 1 console...(Press Ctrl Shift - x to exit)
T=51.5: Election, was member, no change, ID=2, pri=0, 2U(1-2), A=u1, nbr#=1 0, reason: u1: stk-po-chg, ,
```

```
ICX7250-48P Router>
UNIT2:T=1m52.0: Unit 2 is assigned standby by active u1.
```

```
T=1m54.2: Standby u2 start parsing running config from active controller u1
T=1m54.5: Standby u2 finished parsing running config from active controller u1.
T:1m56.8: Done hot swap: standby controller u2 sets u1 to Ready.
Download request from active unit 1 mac = 609c.9f99.3f80
```

```
UNIT2:T=2m54.6: U2 received startup config flash sync.
Done.
```

Creating a two-unit linear-topology stack using stack zero-touch provisioning

Stack zero-touch provisioning elects to form a linear-topology trunk only when the active controller has a linear-topology trunk configuration for itself. If the active controller does not have a linear-topology trunk configuration, stack zero-touch provisioning forms a ring.

The following procedure uses an ICX 7250 stack as an example. A two-unit ICX 7250 stack has two potential linear-topology trunks, (x/2/1 to x/2/4) and (x/2/5 to x/2/8). The system configures a four-port trunk and removes the other direction.

NOTE

Neither stack interactive-setup nor stack zero-touch provisioning can convert a live two-unit stack to a linear-topology trunk. If you are working with a live system, you can enter the **multi-stack-trunk 1/2/1 to 1/2/4 and 2/2/1 to 2/2/4** command to change the configuration on both units simultaneously. Refer to [Changing a live two-unit stack to a linear-topology trunk](#) on page 45 for more information.

Complete the following steps to configure a two-unit linear-topology trunk using stack zero-touch provisioning.

NOTE

For more information on stack zero-touch provisioning, refer to [Scenario 2 - Using zero-touch provisioning to configure a stack](#) on page 77.

1. Connect cables between the two units. (In this example, four cables are used as shown in [Figure 4](#) on page 37).
2. On the unit that you want to become the active controller, create the desired trunk in stack unit 1 configuration sub-mode.

```
ICX7250# configure terminal
ICX7250(config)# stack unit 1
ICX7250(config-unit-1)# stack-trunk 1/2/1 to 1/2/4
ICX7250(config-unit-1)# exit
```

The example configures ports 1/2/1 through 1/2/4 as a stacking trunk.

3. On the prospective active controller, enable stacking and zero-touch provisioning as shown in the following example.

```
ICX7250 (config)# stack enable
!
ICX7250 (config)# stack zero-touch-enable
!
```

The first unit detects the other unit within a few minutes.

The first unit reloads the other unit as a stack member.

A two-unit stack forms when the member boots up and joins the stack.

4. Enter the **write memory** command to save the configuration.

```
ICX7250(config)# write memory
```

Changes to Stacking in FastIron Release 08.0.90

Support for two-unit stack linear-topology trunks

The following example shows the discovery of a two-unit ICX 7250 linear-topology stack using stack zero-touch provisioning.

```
ICX7250-48P Router# show running-config
Current configuration:
!
ver 08.0.90
!
stack unit 1
  module 1 icx7250-48p-poe-port-management-module
  module 2 icx7250-sfp-plus-8port-80g-module
  stack-port 1/2/1
  stack-port 1/2/3
!
!
end

ICX7250-48P Router# configure terminal
ICX7250-48P Router(config)# stack unit 1
ICX7250-48P Router(config-unit-1)# stack-trunk 1/2/1 to 1/2/4
stack-trunk 1/2/1 to 1/2/4 replaces stack-port 1/2/1

ICX7250-48P Router(config)# stack enable
Enable stacking. This unit actively participates in stacking

ICX7250-48P Router(config)# stack zero-touch-enable
ICX7250-48P Router(config)# exit
ICX7250-48P Router#

T=7m3.1: Election, was alone --> active, ID=1, pri=128, 2U(1-2), A=u1, nbr#=1 0, reason: u2: enable, ,
Detect stack member 2 POE capable
T=7m3.6: Synchronize webauth files to u2
T=7m5.3: Done hot swap: active controller u1 sets u2 to Ready.
T=7m5.9: Election, was active, no change, ID=1, pri=128, 2U(1-2), A=u1, nbr#=1 0, reason: u1: stk-po-chg, ,

Config changed due to add/del units. Do write mem if you want to keep it
T=8m6.7: Assigned unit 2 to be standby
T=8m8.7: start running config sync to standby u2
T=8m9.6: Running config sync to standby u2 is complete

=====unit 2 log=====
Unit 1 receives stack zero-touch from U1, mac=609c.9f99.3f80
ID=2 D0=2/1 to 2/4, , will reload from Primary in 20 sec
Unmounting the External USB
We are in system reset

#### Bootup printout is snipped

The system : started=warm start   reloaded=by "reload"
My stack unit ID = 2, bootup role = member

[MEMBER]local-2@ICX7250-48P Router>
Creating certificate, please wait...

SSL Client Certificate is successfully created

[MEMBER]local-2@ICX7250-48P Router>

T=45.2: Election, was member, no change, ID=2, pri=0, 2U(1-2), A=u1, nbr#=1 0, reason: u1: hitle-fail-en, ,
Unit 2 becomes ready
Connecting to active controller 1 console...(Press Ctrl Shift - x to exit)

T=48.2: Election, was member, no change, ID=2, pri=0, 2U(1-2), A=u1, nbr#=1 0, reason: u1: stk-po-chg, ,

ICX7250-48P Router>UNIT2:T=1m49.1: Unit 2 is assigned standby by active u1.
T=1m51.3: Standby u2 start parsing running config from active controller u1
T=1m51.5: Standby u2 finished parsing running config from active controller u1.
T:1m53.6: Done hot swap: standby controller u2 sets u1 to Ready.
=====
```

```
ICX7250-48P Router# show running-config
Current configuration:
!
ver 08.0.90
!
stack unit 1
  module 1 icx7250-48p-poe-port-management-module
  module 2 icx7250-sfp-plus-8port-80g-module
  priority 128
  stack-trunk 1/2/1 to 1/2/4

stack unit 2
  module 1 icx7250-48p-poe-port-management-module
  module 2 icx7250-sfp-plus-8port-80g-module
  stack-trunk 2/2/1 to 2/2/4

stack enable
stack zero-touch-enable
stack mac 609c.9f99.3f80
!
!
hitless-failover enable
!
!
end

ICX7250-48P Router# show stack
T=4lm18.8: alone: standalone, D: dynamic cfg, S: static
ID  Type      Role   Mac Address  Pri State  Comment
1   S ICX7250-48P  active  609c.9f99.3f80 128 local  Ready
2   D ICX7250-48P  standby 609c.9f99.1988 0  remote Ready

      standby      active
      +---+      +---+
      | 2 |2/1==2/1| 1 |
      +---+      +---+
Standby u2 - protocols ready, can failover
Role history: N: standalone, A: active, S: standby, M: member
U1: N->A

Current stack management MAC is 609c.9f99.3f80
ICX7250-48P Router# write memory
```

Changing a live two-unit stack to a linear-topology trunk

The ICX system performs numerous checks to block commands that could break a live stack. However, the checks have limitations and may not catch all potential breaks. Therefore, you should verify the physical connections on the stack before using the **multi-stack-port** or **multi-stack-trunk** command.

You can use the **show stack connection** command to check the physical connections of stacking ports (data port connections are not shown).

In a live system, you can configure the desired trunk on both units simultaneously using the **multi-stack-trunk** command.

In the following procedure, an ICX 7250 two-unit linear-topology stack is created as an example. Each ICX 7250 device has two potential linear-topology trunks, (x/2/1 to x/2/4) and (x/2/5 to x/2/8). When you configure either trunk, the system creates the specified trunk on each unit and removes the other stacking direction.

1. Enter global configuration mode on the active controller.

```
ICX 7250# configure terminal
```

Changes to Stacking in FastIron Release 08.0.90

Support for two-unit stack linear-topology trunks

2. Enter stack unit configuration sub-mode on the active controller.

```
ICX 7250(config)# stack unit 1
```

3. Configure the desired trunk on each unit.

Based on existing connections, specify one of the available trunk combinations.

For example, in an ICX 7250 two-unit stack, based on connections, specify one of the following choices for each side of the trunk when entering the **multi-stack-trunk** command:

- x/2/1 to x/2/4
- x/2/5 to x/2/8

```
ICX 7250(config-unit-1)# multi-stack-trunk 1/2/1 to 1/2/4 and 2/2/1 to 2/2/4
```

The system changes any existing **stack-port** or **stack-trunk** configuration to a four-port linear-topology trunk.

In the example, both units form a bidirectional linear-topology stacking trunk on ports x/2/1 through x/2/4.

4. Enter the **write memory** command to save the configuration.

```
ICX 7250(config-unit-1)# exit
ICX 7250(config)# write memory
```

The following example summarizes the creating of a linear-topology trunk and includes system responses.

```
ICX7250-48P Router# configure terminal
ICX7250-48P Router(config)# stack unit 1
ICX7250-48P Router(config-unit-1)# multi-stack-trunk 1/2/1 1/2/2 1/2/3 1/2/4 and 2/2/1 2/2/2 2/2/3 2/2/4
stack-trunk 1/2/1 to 1/2/4 replaces stack-trunk 1/2/1 to 1/2/2 and stack-trunk 1/2/3 to 1/2/4
stack-trunk 2/2/1 to 2/2/4 replaces stack-trunk 2/2/1 to 2/2/2 and stack-trunk 2/2/3 to 2/2/4
ICX7250-48P Router(config-unit-1)# exit

ICX7250-48P Router(config)# show running-config
Current configuration:
!
ver 08.0.90
!
stack unit 1
  module 1 icx7250-48p-poe-port-management-module
  module 2 icx7250-sfp-plus-8port-80g-module
  priority 128
  stack-trunk 1/2/1 to 1/2/4

stack unit 2
  module 1 icx7250-48p-poe-port-management-module
  module 2 icx7250-sfp-plus-8port-80g-module
  stack-trunk 2/2/1 to 2/2/4

stack enable
stack mac 609c.9f99.3f80
!
!
ICX7250-48P Router(config)# write memory
```

Changing a live linear-topology trunk to a ring

The ICX system performs numerous checks to block commands that could break a live stack. However, the checks have limitations and may not catch all potential breaks. Therefore, you should verify the physical connections on the stack before using the **multi-stack-port** or **multi-stack-trunk** command.

You can use the **show stack connection** command to check the physical connections of stacking ports (data port connections are not shown).

Suppose the physical connections displayed only two-port trunk connections on each unit, for example, ports 1/2/3 to 1/2/4 and 2/2/3 to 2/2/4. To change the existing live configuration to a stacking ring, the **multi-stack-trunk 1/2/3 to 1/2/4 and 2/2/3 to 2/2/4** command is required.

The following example uses an ICX 7250 two-unit stack with a linear-topology trunk between ports 1/2/1 to 1/2/4 and 2/2/1 to 2/2/4.

Complete the following steps to convert the linear-topology trunk to a stacking ring.

1. Enter global configuration mode on the active controller.

```
ICX 7250# configure terminal
```

2. Enter stack unit 1 configuration sub-mode on the active controller.

```
ICX 7250(config)# stack unit 1
```

3. Enter the following command to modify the configuration of the live trunk.

```
ICX 7250(config-unit-1)# multi-stack-trunk 1/2/1 to 1/2/2 and 2/2/1 to 2/2/2
```

NOTE

If there is no physical link on port 1/2/1 or 1/2/2, use the command **multi-stack-trunk 1/2/3 to 1/2/4 and 2/2/3 to 2/2/4**.

The system removes ports 1/2/3, 1/2/4, 2/2/3, and 2/2/4 from the linear-topology trunk. They become data ports.

4. Enter the following command to create a two-port trunk configuration on the active controller.

```
ICX 7250(config-unit-1)# stack-trunk 1/2/3 to 1/2/4
```

NOTE

The **stack-trunk** command is used in this case because ports 1/2/3 and 1/2/4 have become data ports and are not considered live stacking ports. The same applies to the ports on unit 2 in subsequent steps.

5. Enter stack unit 2 configuration sub-mode on the active controller.

```
ICX 7250(config-unit-1)# stack unit 2
```

6. Create a connecting two-port trunk for stack unit 2.

```
ICX 7250(config-unit-2)# stack-trunk 2/2/3 to 2/2/4
```

The system performs an election and forms a stacking ring.

7. Enter the **write memory** command to save the configuration.

```
ICX 7250(config-unit-2)# exit  
ICX 7250(config)# write memory
```

Changes to Stacking in FastIron Release 08.0.90

Support for two-unit stack linear-topology trunks

NOTE

The preceding steps require the operator to enter commands to form trunks from data ports in steps 6 and 7.

The following example summarizes the conversion of a two-unit stack linear-topology ring to a stacking ring topology and includes system output.

```
ICX7250-48P Router# configure terminal
ICX7250-48P Router(config)# stack unit 1
ICX7250-48P Router(config-unit-1)# multi-stack-trunk 1/2/1 1/2/2 and 2/2/1 2/2/2
stack-trunk 1/2/1 to 1/2/2 replaces stack-trunk 1/2/1 to 1/2/4
stack-trunk 2/2/1 to 2/2/2 replaces stack-trunk 2/2/1 to 2/2/4

ICX7250-48P Router(config-unit-1)# stack-trunk 1/2/3 1/2/4
ICX7250-48P Router(config-unit-1)# stack unit 2
ICX7250-48P Router(config-unit-2)# stack-trunk 2/2/3 2/2/4
ICX7250-48P Router(config-unit-2)# exit
ICX7250-48P Router(config)#

ICX7250-48P Router(config-unit-1)# show running-config
Current configuration:
!
ver 08.0.90
!
stack unit 1
  module 1 icx7250-48p-poe-port-management-module
  module 2 icx7250-sfp-plus-8port-80g-module
  priority 128
  stack-trunk 1/2/1 to 1/2/2
  stack-trunk 1/2/3 to 1/2/4
stack unit 2
  module 1 icx7250-48p-poe-port-management-module
  module 2 icx7250-sfp-plus-8port-80g-module
  stack-trunk 2/2/1 to 2/2/2
  stack-trunk 2/2/3 to 2/2/4
stack enable
stack mac 609c.9f99.3f80
!
ICX7250-48P Router(config-unit-1)# exit
ICX7250-48P Router(config)# write memory
```

Building a Stack

- Planning to build a stack..... 49
- Planning to build a stack with 802.1br switch port extender capability..... 55
- Stack construction methods..... 56
- Verifying a stack configuration.....85
- Displaying information on stack connections.....87

Planning to build a stack

Before you begin to build a stack, you should be familiar with supported stacking software requirements, topologies, and recommendations.

Software requirements

All units in a stack must be running the same software version.

Maximum configuration file size for any stack is 1 MB.

Stack requirements

Stacks must contain devices of the same type or product line. For example, a stack cannot combine ICX 7150, ICX 7250, ICX 7450, ICX 7650, ICX 7750, or ICX 7850 devices. However, a stack can contain any combination of devices from the same product line, for example, any combination of ICX 7250 devices.

NOTE

A core stack for an 802.1br (SPX) configuration is a stack that contains only ICX 7750 devices or only ICX 7650 devices, although the stack may contain different types of ICX 7750 or ICX 7650 devices. Refer to the *Ruckus FastIron Campus Fabric Configuration Guide* for more information.

Ruckus stacking topologies

Ruckus stacking technology supports linear and ring topologies.

Although Ruckus stackable units may be connected in a simple linear topology, Ruckus recommends a ring topology because it offers the best redundancy and the most resilient operation. Unicast switching follows the shortest path in a ring topology. When the ring is broken, the stack recalculates the forwarding path and then resumes the flow of traffic within a few seconds.

In a ring topology, all stack members must have two stacking directions; however, in a linear topology, both end units use only one stacking direction. A direction may be represented by a stacking port or a stacking trunk that contains multiple ports. A stacking trunk provides better bandwidth and redundancy.

FastIron stacking distances and optics by device

Because Ruckus devices use Ethernet for the inter-switch stack connections, the deployment options are greatly increased. If standard copper stacking cables are used, the inter-switch connections can be up to 5 meters, which is usually sufficient for locally distributed stacks, such as in Top-of-Rack (ToR) applications. For broader distribution, fiber-optic cables should be used, allowing a stack to be deployed across multiple physical locations, such as in the wiring closets of an office building, or in different buildings on a campus.

Cables that support different distances can be combined in the same stack. For example, you can use LR4 Single Mode Fiber (SMF) optics at both ends of a stacking connection, and the maximum distance is extended to 10 kilometers. Other stacking ports in the same stack can use other optics, such as SR4, at both ends. The maximum distance for such a connection is 100 meters.

NOTE

The same optics (for example, LR4) must be used on both ends of a connection. If the optics do not match on both ends, the ports will not come up.

The following table shows copper and fiber-optic options approved for stacking and stacking distance combinations.

TABLE 15 Copper and fiber-optic options and stacking distances

Device	Stacking port	Copper options	Fiber-optic options	Fiber-optic maximum stacking distance
ICX 7850	32Q: 8 X 100-Gbps or 8 X 40-Gbps stacking or uplink on Module 3 48F/48FS: 8 X 100-Gbps or 8 X 40-Gbps stacking or uplink on Module 2	40 Gbps: QSFP-QSFP passive cable: 0.5-, 1-, 3-, or 5-meter 1-, 3-, or 5-meter QSFP-QSFP active direct-attach copper 10-meter QSFP-QSFP Active Optical Cable (AOC) 100 Gbps: QSFP28-QSFP28 passive cable: 1-, 3-, or 5-meter	40G-QSFP-SR4	100 meters
			40G-QSFP-BiDi	
			40G-QSFP-LM4	140 meters
			40G-QSFP-eSR4	300 meters
			40G-QSFP-LR4	10 kilometers
			40G-QSFP-ER4	40 kilometers
			100G-QSFP28-LR4-10KM, 3.5W	10 kilometers
			100G-QSFP28-CWDM4-2KM	2 kilometers
			100G-QSFP28-SR4	100 meters
ICX 7750	6 X 40-Gbps Front and rear stacking and uplink	0.5- or 1-meter passive copper 1-, 3-, or 5-meter QSFP-QSFP active direct-attach copper 10-meter QSFP-QSFP Active Optical Cable (AOC)	40G-QSFP-SR4	100 meters
			40G-QSFP-BiDi	
			40G-QSFP-LM4	140 meters
			40G-QSFP-eSR4	300 meters
			40G-QSFP-LR4	10 kilometers
			40G-QSFP-ER4	40 kilometers
ICX 7650	4 X 40-Gbps stacking or uplink, or 2 X 100-Gbps stacking or uplink on slot 3	40 Gbps: 0.5- or 1-meter passive copper 1-, 3-, or 5-meter QSFP-QSFP active direct-attach copper 10-meter QSFP-QSFP Active Optical Cable (AOC) ³ 100 Gbps: ⁴ 1-, 3-, or 5-meter QSFP28 to QSFP28 Passive Copper Cable	40G-QSFP+-SR4	100 meters
			40G-QSFP+-BiDi	
			40G-QSFP+-LR4	10 kilometers
			100G-QSFP28-LR4-10KM, 3.5W	
			100G-QSFP28-LR4L-2KM, 4W	2 kilometers
			100G-QSFP28-CWDM4-2KM	
			100G-QSFP28-SR4	100 meters

TABLE 15 Copper and fiber-optic options and stacking distances (continued)

Device	Stacking port	Copper options	Fiber-optic options	Fiber-optic maximum stacking distance
ICX 7450 (rear)	1 X 40-Gbps stacking and uplink on slots 3 and 4 ⁵	0.5- or 1-meter SFP+ passive copper 1-, 3-, or 5-meter QSFP-QSFP active direct-attach copper	40G-QSFP-SR4	100 meters
			40G-QSFP-eSR4	300 meters
			40G-QSFP-LR4 ⁶	10 kilometers
ICX 7450 (front)	4 X 10-Gbps stacking on slot 2 with the icx7400-4x10GF module only	1-, 3-, or 5-meter SFP+ passive cables 1-, 3-, or 5-meter SFP+ active direct-attach copper 7- or 10-meter SFP+ Active Optical Cable (AOC)	10G-SFPP-USR	100 meters
			10G-SFPP-SR	300 meters
			10G-SFPP-LR	10 kilometers
ICX 7250	4 X 10-Gbps stacking from dedicated or uplink ports 4 X 10F SFP+ Uplink Ports: No-PHY 4 X 10F SFP+ Stacking Ports: With re-timer capability	1-, 3-, or 5-meter SFP+ passive cables 1-, 3-, or 5-meter active cables	10GE SR SFP+	300 meters
			10GE USR SFP+	100 meters
			10GE LR SFP+	10 kilometers
ICX 7150	Standard 2 X 10-Gbps stacking 4 X 10-Gbps stacking from dedicated or uplink ports if an ICX 7150-48ZP is present 2 X 10-Gbps stacking only on ICX 7150-C12P devices Up to 4 X 10F SFP+ uplink Ports: No-PHY Up to 4 X 10F SFP+ stacking ports: With re-timer capability	1- or 3-meter SFP+ passive cables 1-, 3-, or 5-meter active cables	10GE SR SFP+	300 meters
			10GE USR SFP+	100 meters
			10GE LR SFP+	10 kilometers

Long-distance stacking ports

Only certain FastIron stacking devices support long-distance stacking. The following table lists FastIron devices and ports that support 100-Gbps long-distance data and stacking connections.

TABLE 16 FastIron long-distance 100-Gbps ports

Product and model	Ports that support 1 X 100-Gbps optics	Long-distance stacking ports
ICX 7650 (all models)	1/3/1, 1/3/2 ⁷	1/3/1, 1/3/2

³ For data uplink only, the 10-meter QSFP-QSFP Active Optical Cable (AOC) is supported on ICX 7650 devices.

⁴ For data uplink only, the 10-meter QSFP28 to QSFP28 AOC Cable is supported on ICX 7450 and ICX 7650 devices.

⁵ For data uplink only, the following 40-Gbps optics are available on ICX 7450 devices: 40G-QSFP-BiDi, 40G-QSFP-LM4.

⁶ Refer to "Long-distance stacking ports" in this guide for more information.

TABLE 16 FastIron long-distance 100-Gbps ports (continued)

Product and model	Ports that support 1 X 100-Gbps optics	Long-distance stacking ports
ICX 7850-32Q	1/2/1 through 1/2/12, 1/3/1 through 1/3/8	1/3/1 through 1/3/8
ICX 7850-48F/48FS	1/2/1 through 1/2/8	1/2/1 through 1/2/8

NOTE

For a list of 100-Gbps optics available for FastIron devices, refer to "FastIron stacking distances and optics by device" in this guide.

FastIron models and 40-Gbps ports that can be used for long-distance data and stacking connections are listed in the following table.

TABLE 17 FastIron long-distance 40-Gbps ports

Product and model	Ports that support 1 X 40-Gbps optics	Long-distance stacking ports
ICX 7450 (all models)	1/3/1, 1/4/1 ⁸	1/3/1, 1/4/1
ICX 7650 (all models)	1/3/1, 1/3/2, 1/3/3, 1/3/4 ⁹	1/3/1, 1/3/2, 1/3/3, 1/3/4
ICX 7750-26Q	1/1/1 through 1/1/20; 1/2/1 through 1/2/6; 1/3/1 through 1/3/6	1/2/1 through 1/2/6; 1/3/1 through 1/3/6
ICX 7750-48F	1/2/1 through 1/2/6; 1/3/1 through 1/3/6	1/2/1 through 1/2/6; 1/3/1 through 1/3/6
ICX 7750-48C	1/2/1 through 1/2/6; 1/3/1 through 1/3/6	1/2/1 through 1/2/6; 1/3/1 through 1/3/6
ICX 7850-32Q	1/2/1 through 1/2/12, 1/3/1 through 1/3/8	1/3/1 through 1/3/8
ICX 7850-48F/48FS	1/2/1 through 1/2/8	1/2/1 through 1/2/8

NOTE

For a list of 40-Gbps optics available per FastIron device, refer to [FastIron stacking distances and optics by device](#) on page 50.

LR optics can be used on ICX 7450 4 X 10-Gbps ports when a 4X10GF module is present. LR optics can also be used on ICX 7150 ports when either a 4X10GF module or 2X10GF module is present. LR optics can support distances up to 10 kilometers for data or stacking. The following table summarizes LR support on ICX 7150 and ICX 7450 devices.

TABLE 18 FastIron long-distance 2X10-Gbps and 4X10-Gbps ports

Product and model	10-Gbps ports that support LR optics	Long-distance stacking ports
ICX 7150-48ZP	1/2/1 through 1/2/8	1/2/1 through 1/2/4
ICX 7150-48, ICX 7150-48P, ICX 7150-48PF, ICX 7150-24, ICX 7150-24P	1/2/1 through 1/2/4	1/2/1 through 1/2/4
ICX 7150-C12P (2X10GF module)	1/3/1 and 1/3/2	1/3/1 and 1/3/2
ICX 7450 front (all models, with 4X10GF module)	1/2/1 through 1/2/4	1/2/1 through 1/2/4

⁷ When ICX 7650-48F/P/ZP devices are configured in stacking mode, front panel slot 2 also supports 2 X 40-Gbps or 1 X 100-Gbps modules with their respective Ruckus-qualified optical hardware.

⁸ ICX 7450-24/24P devices also support a 1 X 40-Gbps module in front panel slot 2 (port 1/2/1).

⁹ When ICX 7650-48F/P/ZP devices are configured in stacking mode, front panel slot 2 also supports 2 X 40-Gbps or 1 X 100-Gbps modules with their respective Ruckus-qualified optical hardware.

TABLE 18 FastIron long-distance 2X10-Gbps and 4X10-Gbps ports (continued)

Product and model	10-Gbps ports that support LR optics	Long-distance stacking ports
ICX 7450 back (all models, with 4X10GF module)	1/3/1 through 1/3/4 and 1/4/1 through 1/4/4 (data only)	1/3/1 through 1/3/4 and 1/4/1 through 1/4/4

For general information on all long-distance stacking options for all FastIron stacking models, refer to [FastIron stacking distances and optics by device](#) on page 50. For details on setting up for long-distance stacking on ICX 7750 devices, refer to [Installing the ICX 7750 in a remote stack](#) on page 143.

Displaying information on supported distances

Use the **show media** command to display information on stacking connections and supported distances. You can specify any interface within a stack or SPX configuration as shown in the following examples. You can also designate a stack to display all media attached to the stack. Without parameters, the **show media** command displays all media attached to the device.

The following example displays information for an interface with an LR4 optic.

```
ICX7750-48F Router# show media ethernet 4/2/6
Port 4/2/6: Type : 40GE-LR4 10km (QSFP+ LC)
Vendor: RUCKUS Version: 2
Part# : 57-1000263-01 Serial#: LDJ21325C230002
```

The following command output is for an interface with a 40-Gbps active copper optic with a maximum distance of 10 meters.

```
ICX7750-48F Switch# show media ethernet 3/2/1
Port 3/2/1: Type : 40GE-Active Copper 10m (QSFP+)
Vendor: RUCKUS Version: A
Part# : 57-1000306-01 Serial#: NEA1151000003S
```

The following output is for an interface with a 40-Gbps ESR4 optic.

```
ICX7750-48F Switch# show media ethernet 1/2/3
Port 1/2/3: Type : 40GE-ESR4 300m (QSFP+)
Vendor: RUCKUS Version: A
Part# : 57-1000296-01 Serial#: LVA115150000004
```

The following example displays information about the media attached to the device.

```
device# show media

Port 1/1/1 : Type : 1G M-C (Gig-Copper)
Port 1/1/2 : Type : 1G M-C (Gig-Copper)
Port 1/1/3 : Type : 1G M-C (Gig-Copper)
Port 1/1/4 : Type : 1G M-C (Gig-Copper)
Port 1/1/5 : Type : 1G M-C (Gig-Copper)
Port 1/1/6 : Type : 1G M-C (Gig-Copper)
Port 1/1/7 : Type : 1G M-C (Gig-Copper)
Port 1/1/8 : Type : 1G M-C (Gig-Copper)
Port 1/1/9 : Type : 1G M-C (Gig-Copper)
Port 1/1/10: Type : 1G M-C (Gig-Copper)
Port 1/1/11: Type : 1G M-C (Gig-Copper)
Port 1/1/12: Type : 1G M-C (Gig-Copper)
Port 1/1/13: Type : 1G M-C (Gig-Copper)
Port 1/1/14: Type : 1G M-C (Gig-Copper)
Port 1/1/15: Type : 1G M-C (Gig-Copper)
Port 1/1/16: Type : 1G M-C (Gig-Copper)
Port 1/1/17: Type : 1G M-C (Gig-Copper)
Port 1/1/18: Type : 1G M-C (Gig-Copper)
Port 1/1/19: Type : 1G M-C (Gig-Copper)
Port 1/1/20: Type : 1G M-C (Gig-Copper)
Port 1/1/21: Type : 1G M-C (Gig-Copper)
Port 1/1/22: Type : 1G M-C (Gig-Copper)
Port 1/1/23: Type : 1G M-C (Gig-Copper)
Port 1/1/24: Type : 1G M-C (Gig-Copper)
```

Building a Stack

Planning to build a stack

```
Port 1/2/1 :      Type : 10GE SR 300m (SFP +)
Port 1/2/2 :      Type : EMPTY
Port 1/2/3 :      Type : 1G Twinax 1m (SFP)
Port 1/2/4 :      Type : 1G Twinax 1m (SFP)
```

The following example shows output for the specified stack.

```
device# show media stack 1

Port 1/1/1 :      Type : EMPTY
Port 1/1/2 :      Type : EMPTY
Port 1/1/3 :      Type : EMPTY
Port 1/1/4 :      Type : EMPTY
Port 1/1/5 :      Type : EMPTY
Port 1/1/6 :      Type : EMPTY
Port 1/1/7 :      Type : EMPTY
Port 1/1/8 :      Type : EMPTY
Port 1/1/9:1 :    Type : 4x10GE Active Copper 1m (QSFP+)
Port 1/1/9:2 :    Type : 4x10GE Active Copper 1m (QSFP+)
Port 1/1/9:3 :    Type : 4x10GE Active Copper 1m (QSFP+)
Port 1/1/9:4 :    Type : 4x10GE Active Copper 1m (QSFP+)
Port 1/1/10 :     Type : EMPTY
Port 1/1/11:1 :   Type : 4x10GE Active Copper 1m (QSFP+)
Port 1/1/11:2 :   Type : 4x10GE Active Copper 1m (QSFP+)
Port 1/1/11:3 :   Type : 4x10GE Active Copper 1m (QSFP+)
Port 1/1/11:4 :   Type : 4x10GE Active Copper 1m (QSFP+)
Port 1/1/12 :     Type : EMPTY
Port 1/1/13 :     Type : EMPTY
Port 1/1/14 :     Type : EMPTY
Port 1/1/15 :     Type : EMPTY
Port 1/1/16 :     Type : EMPTY
Port 1/1/17 :     Type : EMPTY
Port 1/1/18 :     Type : EMPTY
Port 1/1/19 :     Type : EMPTY
Port 1/1/20 :     Type : EMPTY
Port 1/2/1 :      Type : EMPTY
Port 1/2/2 :      Type : EMPTY
Port 1/2/3 :      Type : EMPTY
Port 1/2/4 :      Type : EMPTY
Port 1/2/5 :      Type : EMPTY
Port 1/2/6 :      Type : EMPTY
Port 1/3/1 :      Type : 40GE-SR4 100m (QSFP+)
Port 1/3/2 :      Type : EMPTY
Port 1/3/3 :      Type : EMPTY
Port 1/3/4 :      Type : EMPTY
Port 1/3/5 :      Type : EMPTY
Port 1/3/6 :      Type : EMPTY
```

Stacking configuration guidelines

Before you configure a stack, consider the following guidelines:

- Plan the number of units and how the stacking ports on the units will be connected. For more information, refer to the hardware installation guide for your device.
- The stack should be physically cabled in a linear or ring topology. Connect only those units that will be active in the stack.
- Make sure all units intended for the stack are running the same software version. On any of the console ports in the stack, use the **show version** command to view all units, or the **show version unit *unit-number*** command to view an individual unit.

NOTE

If you are running a router image and there is a potential loop in your topology, you must configure the Spanning Tree Protocol in the would-be active controller. Otherwise, excessive looping packets may affect stack formation. The Spanning Tree Protocol is enabled by default in switch images.

NOTE

If STP is not enabled, there may be a loop issue when multiple cables are used to connect a standalone unit to a stack. The loop does not affect stack formation. The loop issue disappears after the multiple links are converted to stacking trunks when the standalone unit is integrated to the stack. However, temporary looping may cause some data traffic interruption.

NOTE

If you want to enlarge a live link or change a linear stack to a ring in a production network, it is better to use **stack-port** or **stack-trunk** commands or, for live links, **multi-stack-trunk** commands to make the configuration changes before you connect the new links. If you connect new links first without the new configuration, the new links cause Layer 2 loops and possible data traffic interruption. After you run `stack interactive-setup` to discover these new links and generate new configuration for the new links, the loop issue disappears.

- When you have a stack of eight or more units, you may need to increase the trap hold time from the default (60 seconds) to five minutes (300 seconds). This will prevent the loss of initial boot traps. To increase the trap hold time, use the following command.

```
device# configure terminal
device(config)# snmp-server enable traps holddown-time 300
```

Planning to build a stack with 802.1br switch port extender capability

If you are planning to create an 802.1br SPX configuration with an ICX 7650 or ICX 7750 core stack, there are a few considerations.

In general, Ruckus stacking and 802.1br SPX configuration are independent. Here are a few details to keep in mind:

- Only ICX 7650 devices or ICX 7750 devices can serve as the control bridge (CB). The CB can be a standalone unit or a stack of multiple units.
- ICX 7150, ICX 7250, and ICX 7450 devices can be configured as PE units attached to the CB. PE units can be attached to any CB unit.
- While a stack may include up to 12 units, a CB stack of no more than four units is recommended.
- ICX 7750 breakout ports can be used with an 802.1br SPX configuration; however, they can be enabled only in a standalone ICX 7750 unit.
- SPX runs over LLDP protocol at Layer 2. When you enable SPX with the **spx cb-enable** command, the **lldp run** command is also executed if LLDP has not previously been enabled.
- You will need to plan a server location from which images and manifest files can be downloaded to PE units.
- In general, ICX 7650 and ICX 7750 devices in the CB retain all capabilities. The feature set of devices operating as PE units, however, may be affected.

For detailed information on 802.1br SPX configuration, including protocol considerations, refer to the *Ruckus FastIron Campus Fabric Configuration Guide*.

Stack construction methods

NOTE

The principles outlined in stack construction scenarios apply to all ICX devices. Figures used to illustrate a certain stack topology are not necessarily representative of other devices. For illustrations specific to a particular device, refer to the stack configuration section for that device, which also contains device-specific stacking considerations.

There are several ways to build a stack.

1. The stack interactive-setup utility. Interactive-setup gives you control over the design of your stack topology and provides security through password verification. Ruckus recommends interactive-setup because it provides the flexibility to choose stack members and their IDs. As you create the stack, you can see the topology and any potential connection errors. Refer to [Scenario 1 - Using stack interactive-setup to create a stack](#) on page 57 for more information.
2. Stack zero-touch provisioning. With this method, after all members are connected, you configure stack zero-touch-enable on the unit that will ultimately serve as the stack active controller. All other units must be clean units, without startup or running configuration. The zero-touch provisioning process is triggered every three minutes in background. The results of the process are equivalent to running stack interactive-setup utility option 2 and accepting all suggested values. Refer to [Scenario 2 - Using zero-touch provisioning to configure a stack](#) on page 77 for more information.
3. Manual stack configuration. With this method, you configure every unit individually and enable stacking on each unit. Once the units are connected together, they automatically operate as a stack. With this method, the unit with the highest priority becomes the active controller, and ID assignment is determined by the sequence in which you physically connect the units. Refer to [Scenario 3 - Manually configuring a three member stack in a ring topology](#) on page 83 for more information.

The stack interactive-setup utility

NOTE

Stack interactive-setup works for units within a single stack. It does not work across stacks.

Stack interactive-setup lets you easily configure your entire stack through the active controller, which propagates the configuration to all stack members. Stack interactive-setup is the most secure way to build a stack and gives you the most control over how your stack is built. For example, stack interactive-setup offers three security features that prevent unauthorized devices from accessing or joining a stack:

- Authentication of stack interactive-setup packets provides verification that these packets are from a genuine Ruckus stack unit. MD5-based port verification confirms stacking ports.
- A superuser password is required to allow password-protected devices to become members of a stack.
- The **stack disable** command prevents a unit from listening for or sending stacking packets. When a unit is stack-disabled, no other device in the network can force the unit to join a stack.

NOTE

You can configure multiple passwords such as super-user, local-user, and telnet for a standalone unit or a stack. The stack interactive-setup process uses only the super-user password configured by the **enable super-user-password** command.

Stack interactive-setup can also be used to add units to an existing stack and to change the stack IDs of stack members.

Stack interactive-setup and the active controller

When the **stack interactive-setup** command is issued on a unit that is not already the active controller, the unit becomes the active controller. If this unit does not already have an assigned priority and if no other unit in the stack has a priority higher than 128, stack interactive-setup assigns the unit a priority of 128 by default. However, if another unit in the stack has a priority of 128 or higher, stack interactive-setup gives the active controller a priority equal to the highest priority unit in the stack (which is by default the standby controller).

Scenario 1 - Using stack interactive-setup to create a stack

The following are connection requirements for discovering new units:

- A port in a valid-stack-port set must be connected; otherwise, the stack interactive-setup utility treats the stack as an invalid topology. For example, one valid-stack-port set for ICX 7750 devices is (x/2/1, x/2/4, 3). You must connect either x/2/1 or x/2/4.

NOTE

The valid-stack-port requirement does not apply to the process of discovering new links between existing units, which enlarges stack-trunks or converts a chain to a ring.

- The connections must form a contiguous stack-trunk even if there are "holes" in the connections. For the previous ICX 7750 example, the two links 1/2/1 to 2/2/4 and 1/2/3 to 2/2/6 will form stack-trunk 1/2/1 to 1/2/3 and stack-trunk 2/2/4 to 2/2/6.
- The connecting ports must not have data port configuration.

NOTE

The active controller of a stack or a standalone with stacking enabled can initiate interactive setup to discover new stack units. The following procedure is performed from a standalone unit.

NOTE

Stack interactive-setup can discover new units and new links between existing units. If the process detects both new units and new links, it first handles the new links between existing units and terminates. The system then requests that you run stack interactive-setup again to discover new units.

Perform these steps to create a stack using the stack interactive-setup utility.

1. Connect the devices using the stacking ports and stack cabling. For more information, refer to the stacking overview for the device and to the appropriate hardware installation guide.
2. Power on the units.
3. Connect your console to the intended active controller. The unit through which you run stack interactive-setup becomes the active controller by default.

- (Optional) Enter the **show running-config** command to check the current configuration of the standalone from which you plan to construct the stack. The configuration must include **stack enable**.

```
ICX7750-48F Router# show running-config
Current configuration:
!
ver 08.0.90
!
stack unit 1
  module 1 icx7750-48-xgf-port-management-module
  module 2 icx7750-qsfp-6port-qsfp-240g-module
  module 3 icx7750-6q-6port-qsfp-240g-module
  stack-port 1/2/1
  stack-port 1/2/4

stack enable
stack mac cc4e.246d.9e00
!
!
!

end
ICX7750-48F Router#
```

The example shows that stacking probes are enabled on the standalone from which the stack is to be discovered.

- If stacking is not enabled on the unit, enter the **stack enable** command in global configuration mode.

```
ICX7750-48F Router# configure terminal
ICX7750-48F Router(config)# stack enable
Enable stacking. This unit actively participates in stacking
ICX7750-48F Router(config)# exit
```

- Enter the **stack interactive-setup** command in Privileged EXEC mode on the standalone that will serve as the active controller for the stack.

NOTE

The **stack secure-setup** command has been deprecated and replaced by the **stack interactive-setup** command. If you enter the **stack secure-setup**, the system responds with an error and instructs you to use the new command.

NOTE

The stack interactive-setup process can be initiated by a standalone unit or by the active controller of a stack. In the following example, the process is initiated by a standalone.

- Select from the available options as shown in the following example. If you are building a stack for the first time and the attached units are clean units with no startup configuration, select **2**.

NOTE

Units with any startup configuration in flash memory are not discovered by option 2.

NOTE

If the connected units contain configuration, you can select option **3**, which saves the manual steps of removing configuration from the units (using the **erase startup-config** and **reload** commands for each one).

NOTE

An ICX 7650 device with startup-config flash using 40-Gbps stacking ports but no other configuration is treated as a clean unit. Because an ICX 7650 device that uses 40-Gbps stacking requires the **rear-module stack-40g** command followed by the **write memory** and **reload** commands to change the default 100-Gbps stacking ports to 40-Gbps stacking ports, the related startup-config flash must be present.

```
ICX7750-48F Router# stack interactive-setup
You can abort stack interactive-setup at any stage by <ctrl-c>
0: quit
1: change stack unit IDs
2: discover and convert new units (no startup-config flash) to members
3: discover and convert existing/new standalone units to members
2&3 can also find new links and auto-trunk or convert chain(s) to ring.
Please type your selection: 2
Sending probes to ports: u1: 1/2/1 to 1/2/6 1/3/1 to 1/3/6,
```

The command triggers a Ruckus proprietary discovery protocol that begins the discovery process in both upstream and downstream directions. The discovery process produces a list of upstream and downstream devices that are available to join the stack. Interactive-setup can detect up to 11 units in each direction (22 units total); however, you must select a total number of units that is less than the maximum stack size for the device because the controller is also part of the stack.

NOTE

Probes are sent through all qualified ports, that is, ports that are up but have no configuration, excluding any stacking port or stacking trunk connected to a live neighbor.

NOTE

During the stack interactive-setup process, after two minutes of inactivity, authentication for stack members expires, forcing you to restart the process.

NOTE

To exit the stack interactive-setup process, enter **Control-C** at any time.

In the example, the user has selected option 2, which, when clean units are attached, initiates probes to discover other potential stack units and links as shown in the following example. Because the initiating standalone in the example has no live neighbors, it sends stacking probes through ports 1/2/1 through 1/2/6 and ports 1/3/1 through 1/3/6, assuming these ports are up and have no configuration.

```
Existing stack:
=====
+----+
2/4| 1 | <-- Initial topology shows the
+----+   standalone and the active
         stacking port.
Horizontal bars link to discovered units. Vertical bars link to stack units.

Chain #0: =====
#1: icx7750-20-qxg-port-management cc4e.2439.3700
```

Building a Stack

Stack construction methods

```
1/2/4
 |
 |
 2/1
+----+
|#1 |
+----+
```

```
Chain #1: =====
#2: icx7750-48-xgc-port-management cc4e.2439.1a00
```

```
1/2/1
 ||
 ||
 2/1
+----+
|#2 |
+----+
```

Discovered units and their connections to the standalone (unit 1 at top) are displayed.

In the example, two connected units are discovered. The first is connected to the standalone through standalone port 1/2/4 and discovered device port x/2/1. The device is shown as #1 to indicate the order of discovery in the discovered topology but ultimately receives another stack unit ID, as the standalone retains stack ID 1.

NOTE

You can use the MAC address provided for each discovered unit to track its identity prior to stack unit ID assignment.

The second discovered connection in the example, shown as #2 in the discovered topology, also receives a real stack unit ID assignment later in the process. It is connected to stack unit 1 (the initiating standalone) through standalone port 1/2/1 and new unit port x/2/1. The double lines indicate a trunk of at least two ports is available for connection.

8. The active controller automatically checks all prospective stack members to see if they are super-user password-protected. If a unit is password-protected, the utility asks for the password after you select the unit. If the password entered is wrong, the utility repeats the ID selection for the same unit. If you do not know the password, take one of the following actions:
 - Discontinue stack interactive-setup by entering **Control-C**.
 - Obtain the device password from the administrator.
 - Skip the unit by entering 0 as the ID selection for this unit, and continue the stack interactive-setup process for your stack. The password-protected device and all devices connected behind it will not be included in the setup process.

9. As each discovered unit connection is re-displayed, enter **y** when prompted to accept the connection as shown in the following example (or enter **n** to decline the connection).

```

Discovered 2 chain/ring, display chain #0 for processing

Chain #0: =====
#1: icx7750-20-qxg-port-management cc4e.2439.3700

    1/2/4
      |
      |
    2/1
+----+
|#1 |
+----+

Chain #0: Do you want to select this chain? (enter 'y' or 'n'): y
#1: icx7750-20-qxg-port cc4e.2439.3700, type an ID (No: 0, default: 2): <-- The connecting module
                                         type and MAC address
                                         for the first
                                         discovered unit
                                         and the proposed
                                         stack unit ID (2)

Chain #1: =====
#2: icx7750-48-xgc-port-management cc4e.2439.1a00

    1/2/1
      ||
      ||
    2/1
+----+
|#2 |
+----+

Chain #1: Do you want to select this chain? (enter 'y' or 'n'): y
#2: icx7750-48-xgc-port cc4e.2439.1a00, type an ID (No: 0, default: 3): 3 <-- The connecting module
                                         type and MAC
                                         address for the
                                         second discovered
                                         unit and the
                                         proposed stack
                                         unit ID (3)

```

The example shows the connections and identifying information for two accepted stack units, along with proposed IDs assigned by default, stack unit 2 and stack unit 3.

10. As the full topology is re-displayed for confirmation, enter **y** when prompted to confirm the topology (or **n** to decline the topology and terminate the process).

After you accept the topology, the active controller is confirmed, the stack is formed, and a standby controller is designated.

During the interactive-setup process, you are prompted to execute the **write memory** command if there are any changes to the stack-port or stack-trunk configuration on the active controller. At the end of the process, after new units join the stack, you are prompted to execute the **write memory** command to save the configuration of the other units.

NOTE

If you do not issue the **write memory** command when prompted, you may lose the configuration the next time the stack reboots.

```
You selected 1 unit(s): #1: ID=2, #2: ID=3,

      #2                #1
+----+          +----+          +----+
| 3 |2/1==2/1| 1 |2/4--2/1| 2 |
+----+          +----+          +----+  <-- The proposed topology is displayed
                                         with assigned stack IDs.
Proceeding will produce the above topology. Do you accept it? (enter 'y' or 'n'): y
stack interactive-setup discovers 1 unit(s) and sends stack-port/trunk to chain 0: <-- Stack ports
                                         and trunks
                                         form so stack
                                         units can join.

#1 cc4e.2439.3700 U2, D0: 2/1, D1: none  <-- The first discovered chain ("chain 0")
                                         connecting to unit 2 has a direction 0 ("D0")
                                         connection through port 2/2/1.

stack interactive-setup discovers 1 unit(s) and sends stack-port/trunk to chain 1:
#2 cc4e.2439.1a00 U3, D0: 2/1 to 2/3, D1: none  <-- The second discovered chain (chain1)
                                         connecting to stack unit 3, has a
                                         D0 connection through ports
                                         3/2/1 through 3/2/3.

Add stack-trunk 1/2/1 to 1/2/3 for new units to join  <-- Unit 1 forms a stacking trunk on
                                         ports 1/2/1 through 1/2/3 to connect
                                         to stack unit 3.

Configuration changed. Please do "write memory".

ICX7750-48F Router# write memory  <-- You must save the configuration changes.
                                         Here, write memory saves changes to
                                         active controller ports and trunks.
```

In the example, a stacking trunk is formed on ports 1/2/1 through 1/2/3 to connect to stack unit 3.

NOTE

To form a stack, the original stacking port and stacking trunk configuration may be modified or deleted, or new stacking port or trunk configuration may be added. Although the original configuration is not required in discovering units, the system attempts to keep the original configuration when possible, to respect the user's intentions.

After you save the configuration, all stack units except the active controller are reloaded.

The active controller is promoted to a priority of 128. In the example, the standalone (unit 1) that becomes the active controller was already configured with the priority 128. This priority is used in hitless switchover and failover negotiations as described in [Hitless Stacking](#) on page 171.

11. After the units reload and join the stack, the system displays information on the synchronization activities performed for each stack member as shown in the following example.

After units reload and join:

```
T=1h12m4.5: Election, was alone --> active, ID=1, pri=128, 2U(1,3), A=u1, nbr#=1 0, reason: u3: port-
up, ,
Detect stack unit 3 has different startup config flash, will synchronize it
T=1h12m0.7: Synchronize webauth files to u3
T=1h12m6.2: Election, was active, no change, ID=1, pri=128, 2U(1,3), A=u1, nbr#=1 0, reason: u1: stk-
po-chg, ,
T=1h12m5.0: Done hot swap: active controller u1 sets u3 to Ready.
T=1h12m5.7: Synchronize startup config to u3
Flash Memory Write (8192 bytes per dot)
.
Write startup-config done.

Config changed due to add/del units. Do write mem if you want to keep it <-- Changes to stack
units must be
saved with
write memory.

Stack unit 3 Power supply 1 is up
Stack unit 3 Power supply 2 is not present
T=1h12m30.3: Election, was active, no change, ID=1, pri=128, 3U(1-3), A=u1, nbr#=1 1, reason: u2:
port-up, ,
Detect stack unit 2 has different startup config flash, will synchronize it
Detect stack unit 2 has different ssl client key, will synchronize it
Detect stack unit 2 has different ssh ssig key, will synchronize it
Detect stack unit 2 has different boot sig key, will synchronize it
T=1h12m26.2: Synchronize webauth files to u2
T=1h12m32.1: Election, was active, no change, ID=1, pri=128, 3U(1-3), A=u1, nbr#=1 1, reason: u1:
stk-po-chg, ,
T=1h12m31.4: Done hot swap: active controller u1 sets u2 to Ready.
T=1h12m31.4: Synchronize startup config to u2
Flash Memory Write (8192 bytes per dot)
.
Write startup-config done.

Config changed due to add/del units. Do write mem if you want to keep it <-- Changes to stack
units must be
saved with
write memory.

Stack unit 2 Power supply 1 is up
Stack unit 2 Power supply 2 is not present
T=1h12m40.2: Synchronize secondary sig key to u2
T=1h12m42.3: Synchronize boot sig key to u2
T=1h13m38.4: Assigned unit 2 to be standby
T=1h13m40.5: start running config sync to standby u2
T=1h13m43.2: Running config sync to standby u2 is complete
```

12. **NOTE**

The system reminds you to save configuration changes with the **write memory** command. Before saving the changes to stack members, you can check the stack configuration as shown in subsequent optional steps.

(Optional) Enter the **show stack** command to check the stack topology and the roles assigned to each stack unit and to verify that all units are in the Ready state.

```
ICX7750-48F Router# show stack
T=1h17m36.7: alone: standalone, D: dynamic cfg, S: static
ID  Type           Role      Mac Address    Pri State  Comment
1   S ICX7750-48XGF active  cc4e.246d.9e00 128 local  Ready
2   D ICX7750-26QXG standby cc4e.2439.3700  0 remote Ready
3   D ICX7750-48XGC member  cc4e.2439.1a00  0 remote Ready

          active          standby
+----+      +----+      +----+
| 3 |2/1==2/1| 1 |2/4--2/1| 2 |
+----+      +----+      +----+
Standby u2 - protocols ready, can failover
Role history: N: standalone, A: active, S: standby, M: member
U1: N->A  <-- Stack history. The standalone unit 1 has successfully made the transition to
          active controller. No change of roles has occurred.

Current stack management MAC is cc4e.246d.9e00  <-- The stack management MAC is the MAC
          for the active controller, in this
          case, stack unit 1.

ICX7750-48F Router#
```

The example shows unit 1 is the active controller for the stack. Unit 1 has retained the previously assigned priority of 128. Stack unit 2 has been assigned the role of standby controller. Unit 3 is a regular stack member. The stack history indicates that no other unit has held the role of active controller for this stack. All stack units are in the Ready state. The "D" displayed for units 2 and 3 indicates a dynamic configuration. After you execute the **write-memory** command, the "D" changes to an "S" for static configuration.

13. (Optional) Enter the **show running-config** command to verify additional information, such as the software version running on the stack, the module configuration of each stack unit, and the stacking connections for each unit.

```
ICX7750-48F Router# show running-config
Current configuration:
!
ver 08.0.90
!
stack unit 1
  module 1 icx7750-48-xgf-port-management-module
  module 2 icx7750-qsfp-6port-qsfp-240g-module
  module 3 icx7750-6q-6port-qsfp-240g-module
  priority 128
  stack-trunk 1/2/1 to 1/2/3
  stack-port 1/2/4
stack unit 2
  module 1 icx7750-20-qxg-port-management-module
  module 2 icx7750-qsfp-6port-qsfp-240g-module
  module 3 icx7750-6q-6port-qsfp-240g-module
  stack-port 2/2/1

stack unit 3
  module 1 icx7750-48-xgc-port-management-module
  module 2 icx7750-qsfp-6port-qsfp-240g-module
  module 3 icx7750-6q-6port-qsfp-240g-module
  stack-trunk 3/2/1 to 3/2/3

stack enable
stack mac cc4e.246d.9e00
!
!
!

end
ICX7750-48F Router#
```

NOTE

Additional show commands are available if a deeper verification of stack configuration is necessary. Refer to [Verifying a stack configuration](#) on page 85 for more information.

14. Enter the **write memory** command to save the changes to stack member configuration.

The command initiates configuration synchronization, which copies the configuration file of the active controller to the rest of the stack units.

NOTE

The stack interactive-setup process may modify your configuration with information about new units, stacking ports, and the like. For this reason, it is very important to save this information by issuing the **write memory** command. If you do not do this, you may lose your configuration information the next time the stack reboots.

Building a Stack

Stack construction methods

The following example includes the full stack interactive-setup described in the previous task steps.

```
ICX7750-48F Router# show running-config
Current configuration:
!
ver 08.0.90
!
stack unit 1
  module 1 icx7750-48-xgf-port-management-module
  module 2 icx7750-qsfp-6port-qsfp-240g-module
  module 3 icx7750-6q-6port-qsfp-240g-module
  stack-port 1/2/1
  stack-port 1/2/4

stack enable
stack mac cc4e.246d.9e00
!
!
!

end
ICX7750-48F Router#

ICX7750-48F Router# stack interactive-setup
You can abort stack interactive-setup at any stage by <ctrl-c>
0: quit
1: change stack unit IDs
2: discover and convert new units (no startup-config flash) to members
3: discover and convert existing/new standalone units to members
2&3 can also find new links and auto-trunk or convert chain(s) to ring.
Please type your selection: 2
Sending probes to ports: u1: 1/2/1 to 1/2/6 1/3/1 to 1/3/6,
Existing stack: =====

  +---+
  2/4| 1 |
  +---+
```

Horizontal bars link to discovered units. Vertical bars link to stack units.

```
Chain #0: =====
#1: icx7750-20-qxg-port-management cc4e.2439.3700

  1/2/4
  |
  |
  2/1
  +---+
  |#1 |
  +---+
```

```
Chain #1: =====
#2: icx7750-48-xgc-port-management cc4e.2439.1a00

  1/2/1
  ||
  ||
  2/1
  +---+
  |#2 |
  +---+
```

Discovered 2 chain/ring, display chain #0 for processing

```
Chain #0: =====
#1: icx7750-20-qxg-port-management cc4e.2439.3700
```

```

1/2/4
 |
 |
 2/1
+----+
|#1 |
+----+

```

Chain #0: Do you want to select this chain? (enter 'y' or 'n'): y
#1: icx7750-20-qxg-port cc4e.2439.3700, type an ID (No: 0, default: 2):

Chain #1: =====
#2: icx7750-48-xgc-port-management cc4e.2439.1a00

```

1/2/1
 ||
 ||
 2/1
+----+
|#2 |
+----+

```

Chain #1: Do you want to select this chain? (enter 'y' or 'n'): y
#2: icx7750-48-xgc-port cc4e.2439.1a00, type an ID (No: 0, default: 3): 3

You selected 1 unit(s): #1: ID=2, #2: ID=3,

```

#2          #1
+----+    +----+    +----+
| 3 |2/1==2/1| 1 |2/4--2/1| 2 |
+----+    +----+    +----+

```

Proceeding will produce the above topology. Do you accept it? (enter 'y' or 'n'): y
stack interactive-setup discovers 1 unit(s) and sends stack-port/trunk to chain 0:
#1 cc4e.2439.3700 U2, D0: 2/1, D1: none

stack interactive-setup discovers 1 unit(s) and sends stack-port/trunk to chain 1:
#2 cc4e.2439.1a00 U3, D0: 2/1 to 2/3, D1: none

Add stack-trunk 1/2/1 to 1/2/3 for new units to join

Configuration changed. Please do "write memory".

=====
Step 3: both units are discovered and sent for a reload

After units reload and join:

```

T=1h12m4.5: Election, was alone --> active, ID=1, pri=128, 2U(1,3), A=u1, nbr#=1 0, reason: u3: port-up, ,
Detect stack unit 3 has different startup config flash, will synchronize it
T=1h12m0.7: Synchronize webauth files to u3
T=1h12m6.2: Election, was active, no change, ID=1, pri=128, 2U(1,3), A=u1, nbr#=1 0, reason: u1: stk-po-
chg, ,
T=1h12m5.0: Done hot swap: active controller u1 sets u3 to Ready.
T=1h12m5.7: Synchronize startup config to u3
Flash Memory Write (8192 bytes per dot)
.
Write startup-config done.

```

Config changed due to add/del units. Do write mem if you want to keep it

```

Stack unit 3 Power supply 1 is up
Stack unit 3 Power supply 2 is not present
T=1h12m30.3: Election, was active, no change, ID=1, pri=128, 3U(1-3), A=u1, nbr#=1 1, reason: u2: port-
up, ,
Detect stack unit 2 has different startup config flash, will synchronize it
Detect stack unit 2 has different ssl client key, will synchronize it
Detect stack unit 2 has different ssh sig key, will synchronize it
Detect stack unit 2 has different boot sig key, will synchronize it
T=1h12m26.2: Synchronize webauth files to u2
T=1h12m32.1: Election, was active, no change, ID=1, pri=128, 3U(1-3), A=u1, nbr#=1 1, reason: u1: stk-po-

```

Building a Stack

Stack construction methods

```
chg, ,
T=1h12m31.4: Done hot swap: active controller u1 sets u2 to Ready.
T=1h12m31.4: Synchronize startup config to u2
Flash Memory Write (8192 bytes per dot)
.
Write startup-config done.

Config changed due to add/del units. Do write mem if you want to keep it
Stack unit 2 Power supply 1 is up
Stack unit 2 Power supply 2 is not present
T=1h12m40.2: Synchronize secondary sig key to u2
T=1h12m42.3: Synchronize boot sig key to u2
T=1h13m38.4: Assigned unit 2 to be standby
T=1h13m40.5: start running config sync to standby u2
T=1h13m43.2: Running config sync to standby u2 is complete

ICX7750-48F Router# show stack
T=1h17m36.7: alone: standalone, D: dynamic cfg, S: static
ID  Type          Role      Mac Address      Pri State  Comment
1   S ICX7750-48XGF active   cc4e.246d.9e00  128 local  Ready
2   D ICX7750-26QXG standby  cc4e.2439.3700   0 remote Ready
3   D ICX7750-48XGC member   cc4e.2439.1a00   0 remote Ready

          active          standby
+----+      +----+      +----+
| 3 |2/1==2/1| 1 |2/4--2/1| 2 |
+----+      +----+      +----+
Standby u2 - protocols ready, can failover
Role history: N: standalone, A: active, S: standby, M: member
U1: N->A

Current stack management MAC is cc4e.246d.9e00
ICX7750-48F Router#

ICX7750-48F Router# show running-config
Current configuration:
!
ver 08.0.90
!
stack unit 1
  module 1 icx7750-48-xgf-port-management-module
  module 2 icx7750-qsfp-6port-qsfp-240g-module
  module 3 icx7750-6q-6port-qsfp-240g-module
  priority 128
  stack-trunk 1/2/1 to 1/2/3
  stack-port 1/2/4
stack unit 2
  module 1 icx7750-20-qxg-port-management-module
  module 2 icx7750-qsfp-6port-qsfp-240g-module
  module 3 icx7750-6q-6port-qsfp-240g-module
  stack-port 2/2/1

stack unit 3
  module 1 icx7750-48-xgc-port-management-module
  module 2 icx7750-qsfp-6port-qsfp-240g-module
  module 3 icx7750-6q-6port-qsfp-240g-module
  stack-trunk 3/2/1 to 3/2/3

stack enable
stack mac cc4e.246d.9e00
!
!
!
end
ICX7750-48F Router#

ICX7750-48F Router# write memory  <-- User enters write memory to save stack unit configuration changes.
```

```
Automatic copy to member units: 2 3 <-- System saves the configuration back to the stack members.
Flash Memory Write (8192 bytes per dot)
.
Copy Done.
```

```
Unit 2 Logs: <-- Unit 2 records stack formation activity. Unit 3 and any other stack units
              record similar information.
```

```
=====
ICX7750-26Q Router# show config ===== > Should be empty
INFO: empty config data in the primary area, try to read from backup
INFO: empty config data in the backup area also
```

```
Unit 1 receives stack interactive-setup from U1, mac=cc4e.246d.9e00
ID=2 D0=2/1, D1=none, , will reload in 10 sec
Unmounting the External USB
We are in system resetSyncing file system
Rebooting...
```

```
Bootloader Version: 10.1.12T205 (Jun 06 2018 - 21:41:43)
```

```
SVR: 0x82100120, PVR: 0x80230032
```

```
!
.
.
.
```

```
After boot up unit 2 becomes standby:
```

```
=====
```

```
[MEMBER]local-2@ICX7750-26Q Router> <-- Notice the prompt change on stack unit 2. The prefix [MEMBER]
              indicates that the device has joined a stack and no longer
              operates independently.
```

```
Creating certificate, please wait...
```

```
SSL Client Certificate is successfully created
```

```
[MEMBER]local-2@ICX7750-26Q Router>
Power supply 1 detected.
Power supply 1 is up.
T=1m33.0: Election, was member, no change, ID=2, pri=0, 3U(1-3), A=u1, nbr#=2 0, reason: u1: port-up, ,
T=1m34.8: Election, was member, no change, ID=2, pri=0, 3U(1-3), A=u1, nbr#=2 0, reason: u1: stk-po-chg, ,
Unit 2 becomes ready
Connecting to active controller 1 console...(Press Ctrl Shift - x to exit)
Download request from active unit 1 mac = cc4e.246d.9e00
```

```
There is no startup config file, unable to save legacy config
Downloading - startup-config.txt
UNIT2:T=1m39.9: U2 received startup config flash sync.
Done.
```

```
ICX7750-48F Router>Download request from active unit 1 mac = cc4e.246d.9e00
Downloading - secondary.sig
stack done ssg key sync
Done.
Download request from active unit 1 mac = cc4e.246d.9e00
Downloading - bootrom.sig
stack done bsig key sync
Done.
UNIT2:T=2m46.3: Unit 2 is assigned standby by active u1.
T=2m49.5: Standby u2 start parsing running config from active controller u1
SZ swr host is set to swrqa.ruckuswireless.com
T=2m50.0: Standby u2 finished parsing running config from active controller u1.
UNIT2:Detect stack unit 3 has different ssl client key, will synchronize it
T:2m55.3: Done hot swap: standby controller u2 sets u3 to Ready.
UNIT2:Detect stack unit 1 has different ssl client key, will synchronize it
T:2m56.3: Done hot swap: standby controller u2 sets u1 to Ready.
```

Building a Stack

Stack construction methods

Stack interactive-setup example with ring topology

The following stack interactive-setup example creates a stack in a ring formation. The process is similar to the linear stack example. Option 2 is used to join clean units (with no start-up configuration in flash) to a stack.

```
Please type your selection: 2
Sending probes to ports: u1: 1/2/1 to 1/2/6 1/3/1 to 1/3/6,
Existing stack: =====
      +----+
      2/1| 1 |2/4
      +----+
```

The discovered topology includes two units, indicated as #1 and #2 by the order of their discovery. In this case, the system reports a single chain/ring discovered. In fact, the potential connection forms a continuous ring, which is presented as a single entity for selection as shown in the following snippet.

```
Chain #0: =====
#1: icx7750-48-xgc-port-management cc4e.2439.1a00
#2: icx7750-26-qxg-port-management cc4e.2439.3700

      1/2/1      1/2/4
      ||        |
      ||        |
      2/1        2/1
      +----+    +----+
      |#1 |2/4--2/4|#2 |
      +----+    +----+

Discovered 1 chain/ring
Chain #0: Do you want to select this chain? (enter 'y' or 'n'): y
```

The ID selection of both new units is the same as in the previous example. It is not displayed here.

The ring topology is easier to identify in the final full diagram the system presents for confirmation as shown in the following snippet.

```
You selected 2 unit(s): #1: ID=3, #2: ID=2,

      #1          #2
      +----+    +----+
-2/4| 1 |2/1==2/1| 3 |2/4--2/4| 2 |2/1-
| +----+    +----+    +----+ |
|-----|
Proceeding will produce the above topology. Do you accept it? (enter 'y' or 'n'): y
stack interactive-setup discovers 2 unit(s) and sends stack-port/trunk to chain 0:
#1 cc4e.2439.1a00 U3, D0: 2/1 to 2/3, D1: 2/4
#2 cc4e.2439.3700 U2, D0: 2/1, D1: 2/4
```

The originating unit, unit 1, forms a trunk through ports 1/2/1 and 3/2/1 as indicated by the double dashed line. Unit 1 also forms a stacking connection through port 1/2/4 and port 2/2/1. As the discovered units were already connected, a ring is formed. The output indicates the direction of the different connections. In the example, unit 3 (center) has a direction 0 connection on the stacking trunk 3/2/1 to 3/2/3 (connected to unit 1) and a direction 1 connection on port 3/2/4 (connected to unit 2).

Because unit 1 created a stacking trunk, the configuration has changed and must be saved as indicated in the following snippet.

```
stack-trunk 1/2/1 to 1/2/3 replaces stack-port 1/2/1
Enlarge stack-port 1/2/1 to stack-trunk 1/2/1 to 1/2/3 to match links.

Configuration changed. Please do "write memory"
```

After you confirm the stack topology and save the configuration, all stack members except the active controller reload. You must again issue a **write memory** command to save the stacking-related configuration changes for the new stack units. You can verify

the stack formation with the **show stack** command as shown in the following example. Additional **show** commands are available for checking stack status and configuration as described in [Verifying a stack configuration](#) on page 85.

```
ICX7750-48F Router# show stack
T=10m0.7: alone: standalone, D: dynamic cfg, S: static
ID  Type      Role      Mac Address  Pri State  Comment
1   S ICX7750-48XGF active    cc4e.246d.9e00 128 local  Ready
2   D ICX7750-26QXG standby   cc4e.2439.3700  0 remote Ready
3   D ICX7750-48XGC member    cc4e.2439.1a00  0 remote Ready

      active      standby
      +----+      +----+      +----+
=2/1| 1 |2/4--2/1| 2 |2/4--2/4| 3 |2/1|=
| | +----+      +----+      +----+ |
| |-----|-----|-----|-----|
Standby u2 - Learn other units for 7 sec, protocols may not be ready in 63 s.
Role history: N: standalone, A: active, S: standby, M: member
U1: N->A
```

Current stack management MAC is cc4e.246d.9e00

In the ring stack formed in the example, unit 1 is labeled the active controller, and unit 2 has been assigned the standby controller role.

Each stack unit produces log entries on stack formation as shown in the following example for unit 2. The log includes information on synchronization with the stack, reboot, power supply status, and stacking role and configuration. As noted in the linear stack example, after the unit has joined the stack, its prompt changes (in the following example, to `[MEMBER]` `local-2@ICX7750-26Q Router>`) to reflect it is operating as a stack member, not an independent device.

```
Logs from Master
=====
ICX7750-48F Router# show running-config
Current configuration:
!
ver 08.0.90
!
stack unit 1
  module 1 icx7750-48-xgf-port-management-module
  module 2 icx7750-qsfp-6port-qsfp-240g-module
  module 3 icx7750-6q-6port-qsfp-240g-module
  stack-port 1/2/1
  stack-port 1/2/4
!
!
!
end
ICX7750-48F Router#

ICX7750-48F Router# stack interactive-setup
You can abort stack interactive-setup at any stage by <ctrl-c>
0: quit
1: change stack unit IDs
2: discover and convert new units (no startup-config flash) to members
3: discover and convert existing/new standalone units to members
2&3 can also find new links and auto-trunk or convert chain(s) to ring.
Please type your selection: 2
Sending probes to ports: u1: 1/2/1 to 1/2/6 1/3/1 to 1/3/6,
Existing stack: =====

      +----+
      2/1| 1 |2/4
      +----+
```

Horizontal bars link to discovered units. Vertical bars link to stack units.

Building a Stack

Stack construction methods

```
Chain #0: =====
#1: icx7750-48-xgc-port-management cc4e.2439.1a00
#2: icx7750-20-qxg-port-management cc4e.2439.3700
```

```
    1/2/1      1/2/4
    ||         |
    ||         |
    2/1        2/1
+----+      +----+
|#1 |2/4--2/4|#2 |
+----+      +----+
```

Discovered 1 chain/ring

```
Chain #0: Do you want to select this chain? (enter 'y' or 'n'): y
#1: icx7750-48-xgc-port cc4e.2439.1a00, type an ID (No: 0, default: 3):
#2: icx7750-20-qxg-port cc4e.2439.3700, type an ID (No: 0, default: 2):
```

You selected 2 unit(s): #1: ID=3, #2: ID=2,

```
          #1          #2
+----+ +----+ +----+
-2/4| 1 |2/1==2/1| 3 |2/4--2/4| 2 |2/1-
| +----+ +----+ +----+ |
|-----|
```

```
Proceeding will produce the above topology. Do you accept it? (enter 'y' or 'n'): y
stack interactive-setup discovers 2 unit(s) and sends stack-port/trunk to chain 0:
#1 cc4e.2439.1a00 U3, D0: 2/1 to 2/3, D1: 2/4
#2 cc4e.2439.3700 U2, D0: 2/1, D1: 2/4
```

```
stack-trunk 1/2/1 to 1/2/3 replaces stack-port 1/2/1
Enlarge stack-port 1/2/1 to stack-trunk 1/2/1 to 1/2/3 to match links.
```

Configuration changed. Please do "write memory"

```
ICX7750-48F Router#T=8m31.0: Election, was alone --> active, ID=1, pri=128, 3U(1-3), A=u1, nbr#=2 0,
reason: u3: port-up, ,
T=8m31.6: Synchronize webauth files to u3
T=8m33.0: Election, was active, no change, ID=1, pri=128, 3U(1-3), A=u1, nbr#=2 0, reason: u1: stk-po-
chg, ,
Detect stack unit 2 has different ssl client key, will synchronize it
T=8m33.5: Synchronize webauth files to u2
T=8m36.3: Done hot swap: active controller u1 sets u3 to Ready.
```

```
Config changed due to add/del units. Do write mem if you want to keep it
T=8m38.2: Election, was active, no change, ID=1, pri=128, 3U(1-3), A=u1, nbr#=2 2, reason: u1: port-up, ,
T=8m38.8: Done hot swap: active controller u1 sets u2 to Ready.
Stack unit 2 Power supply 1 is up
Stack unit 2 Power supply 2 is not present
Stack unit 3 Power supply 1 is up
Stack unit 3 Power supply 2 is not present
```

```
Config changed due to add/del units. Do write mem if you want to keep it
T=9m41.1: Assigned unit 2 to be standby
T=9m43.2: start running config sync to standby u2
T=9m46.8: Running config sync to standby u2 is complete
```

-----Unit joined-----

```
ICX7750-48F Router# show stack
T=10m0.7: alone: standalone, D: dynamic cfg, S: static
ID  Type          Role      Mac Address      Pri State  Comment
1  S ICX7750-48XGF active  cc4e.246d.9e00  128 local  Ready
2  D ICX7750-26QXG standby cc4e.2439.3700   0 remote Ready
3  D ICX7750-48XGC member  cc4e.2439.1a00   0 remote Ready
```



```

    active      standby
    +----+      +----+      +----+
=2/1| 1 |2/4--2/1| 2 |2/4--2/4| 3 |2/1|=
| +----+      +----+      +----+ |
|-----|-----|-----|
Standby u2 - Learn other units for 7 sec, protocols may not be ready in 63 s.
Role history: N: standalone, A: active, S: standby, M: member
U1: N->A

Current stack management MAC is cc4e.246d.9e00
ICX7750-48F Router#

```

After units boot up:
=====

```

Unit 2 Logs:
=====
ICX7750-26Q Router#Unit 1 receives stack interactive-setup from U1, mac=cc4e.246d.9e00
ID=2 D0=2/1, D1=2/4, , will reload in 10 sec
Unmounting the External USB
We are in system resetSyncing file system
Rebooting...
:
:
:
:

Bootloader Version: 10.1.12T205 (Jun 06 2018 - 21:41:43)

SVR: 0x82100120, PVR: 0x80230032
!
ICX7750:26Q,Production-1

```

After boot up

```

[MEMBER]local-2@ICX7750-26Q Router>
Creating certificate, please wait...

SSL Client Certificate is successfully created

[MEMBER]local-2@ICX7750-26Q Router>
Power supply 1 detected.
Power supply 1 is up.
T=44.5: Election, was member, no change, ID=2, pri=0, 2U(2-3), No Active, nbr#=0 1, reason: u3: port-up, ,
T=1m21.2: Election, was member, no change, ID=2, pri=0, 3U(1-3), A=u1, nbr#=0 2, reason: u1: port-up, ,
T=1m23.5: Election, was member, no change, ID=2, pri=0, 3U(1-3), A=u1, nbr#=0 2, reason: u1: stk-po-chg, ,
T=1m28.7: Election, was member, no change, ID=2, pri=0, 3U(1-3), A=u1, nbr#=2 2, reason: u1: port-up, ,
Unit 2 becomes ready
Connecting to active controller 1 console...(Press Ctrl Shift - x to exit)

ICX7750-48F Router>UNIT2:T=2m32.2: Unit 2 is assigned standby by active u1.
T=2m36.7: Standby u2 start parsing running config from active controller u1
SZ swr host is set to swrqa.ruckuswireless.com
T=2m37.1: Standby u2 finished parsing running config from active controller u1.
UNIT2:Detect stack unit 3 has different ssl client key, will synchronize it
T:2m38.9: Done hot swap: standby controller u2 sets u3 to Ready.
UNIT2:Detect stack unit 1 has different ssl client key, will synchronize it
T:2m39.6: Done hot swap: standby controller u2 sets u1 to Ready.
!
!
!
ICX7750-48F Router>

```

Auto-trunking new links or converting a linear stack to a ring with stack interactive-setup

NOTE

The stack interactive-setup utility cannot detect mismatched live stack-trunks. For example, if one end of the trunk is stack-trunk 1/2/1 to 1/2/3 and the other end is stack-trunk 2/2/1 to 2/2/2, stack interactive-setup cannot detect the link 1/2/3 to 2/2/3 and enlarge the stack-trunk 2/2/1 to 2/2/2. The reason is that on one end, port 1/2/3 is an internal port, and on the other end, port 2/2/3 is a data port. The two ports cannot communicate. Output for the **show stack** command displays mismatch warning messages. Use the **multi-stack-trunk** command to correct the mismatch problem manually.

NOTE

Neither stack interactive-setup nor stack zero-touch provisioning can convert a live two-unit stack to a linear-topology trunk. If you are working with a live system, you can enter the **multi-stack-trunk 1/2/1 to 1/2/4 and 2/2/1 to 2/2/4** command to change the configuration on both units simultaneously. Refer to [Changing a live two-unit stack to a linear-topology trunk](#) on page 45 for more information.

The following example uses stack interactive-setup to enlarge and add stack-ports and stack-trunks to convert a linear stack to a ring. The **show stack** command displays a three-unit linear stack with a single stacking link between the active controller and unit 3 and a stacking trunk connection between the active and standby controller (unit 2).

```
ICX7750-26Q Router# show stack

T=1d18h10m16.9: alone: standalone, D: dynamic cfg, S: static
ID  Type           Role      Mac Address   Pri State  Comment
1   S ICX7750-26QXG active   cc4e.2438.7280 128 local  Ready
2   S ICX7750-48XGF standby  609c.9f7f.9400 128 remote Ready
3   S ICX7750-26QXG member   748e.f8f9.6300 0 remote Ready

standby      active
+----+      +----+      +----+
| 2 |2/1==2/1| 1 |2/4--2/1| 3 |
+----+      +----+      +----+

Standby u2 - protocols ready, can failover
Current stack management MAC is cc4e.2438.7280
```

When the **stack interactive-setup** command is entered, option 2 is selected to probe for new units. Probes are sent out through the ports indicated on the three stack members.

```
ICX7750-26Q Router# stack interactive-setup
You can abort stack interactive-setup at any stage by <ctrl-c>
0: quit
1: change stack unit IDs
2: discover and convert new units (no startup-config flash) to members
3: discover and convert existing/new standalone units to members
2&3 can also find new links and auto-trunk or convert chain(s) to ring.
Please type your selection: 2
Sending probes to ports: u1: 1/2/3 1/2/5 to 1/2/6, u2: 2/2/3 to 2/2/6 2/3/1 to 2/3/6, u3: 3/2/2 to 3/2/6
3/3/1 to 3/3/6,
```

Although no new units are discovered, six additional links are detected between the existing stack units. The new connections between units 1 and 2 enlarge the stacking trunk to three ports. The existing stacking link between units 1 and 3 are, likewise, enlarged to form a three-port stacking trunk.

The existing stack does not show a connection between units 2 and 3; however, the stack interactive-setup probes have discovered three shared stacking links, which are expanded to a stack-trunk on each side to form a ring.

```
Existing stack: =====
standby      active
+----+      +----+      +----+
| 2 |2/1==2/1| 1 |2/4--2/1| 3 |
```

```

+----+      +----+      +----+
Stack interactive-setup detects 6 new links (classified to 3 logical links) between existing units.
Logical Link #0: U1--U2: 1 link(s): 1/2/3--2/2/3
It will enlarge (stack-trunk 1/2/1 to 1/2/2) to (stack-trunk 1/2/1 to 1/2/3) and enlarge
(stack-trunk 2/2/1 to 2/2/2) to (stack-trunk 2/2/1 to 2/2/3)

Logical Link #1: U1--U3: 2 link(s): 1/2/5--3/2/2 1/2/6--3/2/3
It will enlarge (stack-port 1/2/4) to (stack-trunk 1/2/4 to 1/2/6) and enlarge
(stack-port 3/2/1) to (stack-trunk 3/2/1 to 3/2/3)

Logical Link #2: U2--U3: 3 link(s): 2/2/4--3/2/4 2/2/5--3/2/5 2/2/6--3/2/6    <-- new links discovered
It will add (stack-trunk 2/2/4 to 2/2/6) and add (stack-trunk 3/2/4 to 3/2/6)    on units 2 and 3
The topology will become a ring.

```

If you enter **y** to accept the new configuration, the expanded stack-trunks are formed, and the new stack-trunks between units 2 and 3 form a ring.

```

Do you accept above new link(s)? (enter 'y' or 'n'): y
T=1d18h11m12.0: stack interactive-setup configures stack-trunk 2/2/4 to 2/2/6.
T=1d18h11m12.0: stack interactive-setup configures stack-trunk 3/2/4 to 3/2/6.

Configuration changed. Please do "write memory".

T=1d18h11m13.1: stack interactive-setup configures multi-stack-trunk 1/2/1 to 1/2/3 and 2/2/1 to 2/2/3
stack-trunk 1/2/1 to 1/2/3 replaces stack-trunk 1/2/1 to 1/2/2
stack-trunk 2/2/1 to 2/2/3 replaces stack-trunk 2/2/1 to 2/2/2
T=1d18h11m13.2: stack interactive-setup configures multi-stack-trunk 1/2/4 to 1/2/6 and 3/2/1 to 3/2/3
stack-trunk 1/2/4 to 1/2/6 replaces stack-port 1/2/4
stack-trunk 3/2/1 to 3/2/3 replaces stack-port 3/2/1

Configuration changed. Please do "write memory".

ICX7750-26Q Router#T=1d18h15m7.6: Election, was active, no change, ID=1, pri=128, 3U(1-3), A=u1, nbr#=2 2,
reason: u3: , ,

ICX7750-26Q Router# show stack
Config changed due to add/del units. Do write mem if you want to keep it

T=1d18h11m31.0: alone: standalone, D: dynamic cfg, S: static
ID  Type          Role      Mac Address    Pri State  Comment
1  S ICX7750-26QXG active    cc4e.2438.7280 128 local  Ready
2  S ICX7750-48XGF standby  609c.9f7f.9400 128 remote Ready
3  S ICX7750-26QXG member   748e.f8f9.6300 0 remote Ready

    active          standby
    +----+      +----+      +----+
=2/1| 1 |2/4==2/1| 3 |2/4==2/4| 2 |2/1=
|  +----+      +----+      +----+ |
|-----| <-- Units 2 and 3 connect
|-----|         to form ring

Standby u2 - protocols ready, can failover
Current stack management MAC is cc4e.2438.7280

```

After you have confirmed the configuration, be sure to save the configuration with the **write memory** command.

```

ICX7750-26Q Router# configure terminal
ICX7750-26Q Router(config)# write memory

```

Changing stack unit IDs with stack interactive-setup

The selection **Option 1: change stack unit IDs** allows you to change the ID of a stack unit, except for the active controller. You can change a unit ID to a used or an unused ID. If the ID is used, the system forces you to change the ID of the unit that already uses the ID. As a result, you can use this option to swap IDs or to change to new IDs. If the changed ID would cause the unit to become non-operational due to a module mismatch, the system displays a warning.

Building a Stack

Stack construction methods

NOTE

An ID change requires a reload.

NOTE

The system does not change the configuration of a unit when its ID is changed. For example, if the ID for unit 2 is changed to be unit 3, the configuration of unit 2 ports does not change.

The following example uses stack interactive-setup option 1 to change unit IDs.

```
ICX7750-26Q Router# stack interactive-setup
You can abort stack interactive-setup at any stage by <ctrl-c>
0: quit
1: change stack unit IDs
2: discover and convert new units (no startup-config flash) to members
3: discover and convert existing/new standalone units to members
2&3 can also find new links and auto-trunk or convert chain(s) to ring.
Please type your selection: 1 <-- Choose option 1 to change unit
IDs.
```

```
      active                standby
      +----+                +----+
=2/1| 1 |2/4==2/1| 3 |2/4==2/4| 2 |2/1=
| +----+                +----+
|-----|
|-----|
```

You can change ID of any standby/member. However, the configuration will not change.

Type "done" to finish, or a new ID for unit 3 (default 3): 2 <-- ID entered is not the default.

Warning! unit 3 --> 2 will cause a non-operational unit because of module mismatch. <-- System warning that a unit will become non-operational

ID 2 will be used by unit 3. Please type a new ID for unit 2: 5 <-- Existing unit 2 must change ID.

Change IDs: 3->2, 2->5,

*** Warning! the following ID changes will cause non-operational units due to module config mismatch: 3->2, Warning! some units will be reloaded to take new IDs. <-- System must reload units.

Once you enter **y** to accept, the ID changes are applied.

```
Do you want to proceed? (enter 'y' or 'n'): y
ICX7750-26Q Router#T=1d17h50m27.1: Election, was active, no change, ID=1, pri=128, 3U(1-2,5), A=u1, nbr#=2
2, reason: u2: interactive-setup, ,
T=1d17h46m43.9: *** Warning! put stack u2 MAC=748e.f8f9.6300 to non-operational, reason= config mismatch.
You could recover by configuring "no stack unit 2".
T=1d17h46m43.9: Active unit 1 deletes u3 but keeps its static config.
T=1d17h50m29.7: Election, was active, no change, ID=1, pri=128, 3U(1-2,5), A=u1, nbr#=2 2, reason: u1: stk-
po-chg, ,
T=1d17h46m49.4: reset unit 2: u2 bootup-id=3
T=1d17h46m49.4: reset unit 5: u5 bootup-id=2

Config changed due to add/del units. Do write mem if you want to keep it
T=1d17h46m54.5: Unit 1 loses all neighbors.
T=1d17h46m54.5: Active unit 1 deletes u2 but keeps its static config.
T=1d17h46m55.0: Active U1 deletes U5 and its config because it is learned.

T=1d17h52m46.4: Election, was active, no change, ID=1, pri=128, 2U(1,5), A=u1, nbr#=1 0, reason: u5: port-
up, ,
T=1d17h49m4.9: Synchronize webauth files to u5
T:1d17h49m6.1: Done hot swap: active controller u1 sets u5 to Ready.
Stack unit 5 Power supply 1 is up
Stack unit 5 Power supply 2 is not present
T=1d17h52m50.4: Election, was active, no change, ID=1, pri=128, 2U(1,5), A=u1, nbr#=1 0, reason: u1: stk-po-
chg, ,

Config changed due to add/del units. Do write mem if you want to keep it
```

```

ICX7750-26Q Router#T=1d17h53m14.8: Election, was active, no change, ID=1, pri=128, 3U(1-2,5), A=u1, nbr#=1
1, reason: u2: port-up, ,
T=1d17h49m31.5: *** Warning! put stack u2 MAC=748e.f8f9.6300 to non-operational, reason= config mismatch.
You could recover by configuring "no stack unit 2".

Config changed due to add/del units. Do write mem if you want to keep it
T=1d17h53m21.5: Election, was active, no change, ID=1, pri=128, 3U(1-2,5), A=u1, nbr#=2 2, reason: u2: port-
up, ,

Config changed due to add/del units. Do write mem if you want to keep it

ICX7750-26Q Router# show stack
T=1d17h49m48.5: alone: standalone, D: dynamic cfg, S: static
ID  Type      Role      Mac Address  Pri State  Comment
1   S ICX7750-26QXG active  cc4e.2438.7280 128 local  Ready
2   S ICX7750-26QXG member  748e.f8f9.6300 128 remote NON-OP: config mismatch
3   S ICX7750-26QXG member  0000.0000.0000 0  reserve
5   D ICX7750-48XGF member  609c.9f7f.9400 128 remote  Ready, standby if reloaded

      active
      +----+      +----+      +----+
=2/1| 1 |2/4==2/1| 2 |2/4==2/4| 5 |2/1=
|   +----+      +----+      +----+ |
|   |-----|-----|-----|
There is no standby. Will assign a standby in 50 sec

Current stack management MAC is cc4e.2438.7280

```

Once you have confirmed the configuration, be sure to save the configuration with the **write memory** command.

```

ICX7750-26Q Router# configure terminal
ICX7750-26Q Router(config)# write memory

```

Scenario 2 - Using zero-touch provisioning to configure a stack

All stack member candidates must be correctly connected.

NOTE

The zero-touch provisioning process requires clean devices, with the exception of the active controller. Clean devices do not contain any configuration information.

NOTE

An ICX 7650 device with startup-config flash using 40-Gbps stacking ports but no other configuration is treated as a clean unit. Because an ICX 7650 device that uses 40-Gbps stacking requires the **rear-module stack-40g** command followed by the **write memory** and **reload** commands to change the default 100-Gbps stacking ports to 40-Gbps stacking ports, the related startup-config flash must be present.

If you are adding clean units without a startup or run-time configuration to a stack, you may elect to use the stack zero-touch provisioning process. Follow these steps to construct a stack with zero-touch provisioning.

1. Power on all candidate devices.
2. Log into the device that you want to be the active controller.

Building a Stack

Stack construction methods

3. If necessary, on each candidate, enter the **erase startup-config** command in Privileged-EXEC mode, and reset the device to convert it to a clean unit.

```
ICX7750-26Q Router# erase startup-config
ICX7750-26Q Router# reload-yes
Rebooting...
```

4. (Optional) Enter the **show running-config** command to check the current configuration of the standalone from which you plan to construct the stack. The configuration must include **stack enable**.

```
ICX7750-48F Router# show running-config
Current configuration:
!
ver 08.0.90_b139T203
!
stack unit 1
  module 1 icx7750-48-xgf-port-management-module
  module 2 icx7750-qsfp-6port-qsfp-240g-module
  module 3 icx7750-6q-6port-qsfp-240g-module
  stack-port 1/2/1
  stack-port 1/2/4
!
!
end
```

5. If stacking is not enabled, configure **stack enable** on the unit that will serve as active controller.

```
ICX7750-48F Router# configure terminal
ICX7750-48F Router(config)# stack enable
Enable stacking. This unit actively participates in stacking
ICX7750-48F Router(config)# exit
```

6. On the active controller, in global configuration mode, configure **stack zero-touch-enable**.

```
ICX7750-48F Router# configure terminal
ICX7750-48F Router(config)# stack zero-touch-enable
ICX7750-48F Router(config)# end
ICX7750-48F Router#
```

7. Wait a few minutes, and the active controller should discover the new units and reload them as stack members.

NOTE

When enabled, stack zero-touch provisioning is automatically triggered every three minutes.

The stack forms after the members join.

8. (Optional) Enter the **show stack zero-touch status** command to check the status of stack zero-touch provisioning.

The following example shows that zero-touch provisioning has discovered additional stacking links and has created a stacking trunk that incorporates them.

```
ICX7750-48F Router# show stack zero-touch status
I cannot be discovered by stack zero-touch or interactive-setup option 2. reason: has stack enable
configuration
I can be discovered by stack interactive-setup option 3.
Will clean up in 89.4 sec. Sent last keep-alive 581.1 sec ago.
zero-touch-enable and stack enable are configured. Have done 1 probes
ZTP has converted 0 new units to members.
*** ZTP is going on for 0m0s. state=start. Will trigger again 3 min after done
ZTP postponed due to topology changes: 0
My MAC used in image copy is 748e.f8f9.636e.
ACL #=0, ind=0
ICX7750-48F Router# stack-trunk 1/2/1 to 1/2/3 replaces stack-port 1/2/1 <-- Sequential port links
Enlarge stack-port 1/2/1 to stack-trunk 1/2/1 to 1/2/3 to match links.                discovered. Trunk
                                                                                       replaces port.

Configuration changed. Please do "write memory".
```

9. (Optional) Enter the **show stack** command to verify the units in the entire stack.

```
ICX7750-48F Router# show stack
T=15m2.5: alone: standalone, D: dynamic cfg, S: static
ID  Type      Role      Mac Address  Pri State  Comment
1   S ICX7750-48XGF active  cc4e.246d.9e00 128 local  Ready
2   D ICX7750-26QXG standby cc4e.2439.3700  0 remote Ready
3   D ICX7750-48XGC member  cc4e.2439.1a00  0 remote Ready

      active      standby
      +----+      +----+      +----+
=2/1| 1 |2/4--2/1| 2 |2/4--2/4| 3 |2/1|= <-- Double lines
| +----+      +----+      +----+ | indicate trunk
|                                     | replaces
|-----|-----|-----| single-port link.
Standby u2 - Learn other units for 66 sec, protocols may not be ready in 4 s.
Role history: N: standalone, A: active, S: standby, M: member
U1: N->A

Current stack management MAC is cc4e.246d.9e00
```

10. (Optional) Enter the **show running-config** command for additional information on the stack, including active software version, the module configuration of each stack unit, and their stacking connections.

```
ICX7750-48F Router# show running-config
Current configuration:
!
ver 08.0.90
!
stack unit 1
  module 1 icx7750-48-xgf-port-management-module
  module 2 icx7750-qsfp-6port-qsfp-240g-module
  module 3 icx7750-6q-6port-qsfp-240g-module
  priority 128
  stack-trunk 1/2/1 to 1/2/3
  stack-port 1/2/4
stack unit 2
  module 1 icx7750-20-qxg-port-management-module
  module 2 icx7750-qsfp-6port-qsfp-240g-module
  module 3 icx7750-6q-6port-qsfp-240g-module
  stack-port 2/2/1
  stack-port 2/2/4
stack unit 3
  module 1 icx7750-48-xgc-port-management-module
  module 2 icx7750-qsfp-6port-qsfp-240g-module
  module 3 icx7750-6q-6port-qsfp-240g-module
  stack-trunk 3/2/1 to 3/2/3
  stack-port 3/2/4
stack enable
stack zero-touch-enable
stack mac cc4e.246d.9e00
!
hitless-failover enable
!
end
```

11. When stack construction is complete, remove the stack zero-touch-enable configuration.

NOTE

Although leaving stack zero-touch provisioning enabled is harmless, the process is triggered every three minutes in background, which wastes system resources if there are no more units to discover.

```
ICX7750-26Q Router# configure terminal
ICX7750-26Q Router(config)# no stack zero-touch-enable
```

12. Enter the **write memory** command to save the stack configuration.

```
ICX7750-26Q Router(config)# write memory
```

Zero-touch provisioning example of new link and new unit discovery

The following example shows that a linear two-unit stack can learn new units as well as detect new links between existing units. The example first checks the running configuration before stack zero-touch provisioning is enabled. The utility discovers a new unit, adds a stack-trunk, and enlarges a stack-port into a stack-trunk so that the units can form a three-unit ring. It later detects links and enlarges an existing single-port link between unit 1 and unit 2 into a stack-trunk.

```
ICX7750-26Q Router# show stack
T=1h6m11.2: alone: standalone, D: dynamic cfg, S:
static
ID   Type           Role      Mac Address      Pri State
Comment
1   S ICX7750-26QXG active    cc4e.2438.7280  128 local
Ready
2   S ICX7750-48XGF standby  609c.9f7f.9400  128 remote
Ready
```



```
standby      active
+---+       +---+
| 2 |2/1--2/1| 1 |2/4
+---+       +---+
```

Standby u2 - protocols ready, can failover
Current stack management MAC is cc4e.2438.7280

ICX7750-26Q Router# show running-config
Current configuration:

```
!
ver 08.0.90
!
stack unit 1
  module 1 icx7750-20-qxg-port-management-module
  module 2 icx7750-qsfp-6port-qsfp-240g-module
  module 3 icx7750-6q-6port-qsfp-240g-module
  priority 128
  stack-port 1/2/1
  stack-port 1/2/4
stack unit 2
  module 1 icx7750-48-xgf-port-management-module
  module 2 icx7750-qsfp-6port-qsfp-240g-module
  module 3 icx7750-6q-6port-qsfp-240g-module
  priority 128
  stack-port 2/2/1

stack enable
stack mac cc4e.2438.7280
!
ICX7750-26Q Router# config terminal
ICX7750-26Q Router(config)# stack zero-touch-enable
ICX7750-26Q Router(config)# end
ICX7750-26Q Router#T=1h8m36.9: Add stack-trunk 2/2/4 to 2/2/6 for new units to join <-- New unit
stack-trunk 1/2/4 to 1/2/6 replaces stack-port 1/2/4 discovered
T=1h8m37.0: Enlarge stack-port 1/2/4 to stack-trunk 1/2/4 to 1/2/6 to match links.
```

Configuration changed. Please do "write memory".

T=1h8m48.4: Election, was active, no change, ID=1, pri=128, 2U(1-2), A=u1, nbr#=1 0, reason: u1: stk-po-
chg, ,

Config changed due to add/del units. Do write mem if you want to keep it
T=1h11m36.1: Election, was active, no change, ID=1, pri=128, 3U(1-3), A=u1, nbr#=1 1, reason: u3: port-
up, ,
Detect stack unit 3 has different startup config flash, will synchronize it
T:1h11m31.3: Done hot swap: active controller u1 sets u3 to Ready.
T=1h11m39.1: Election, was active, no change, ID=1, pri=128, 3U(1-3), A=u1, nbr#=1 1, reason: u1: stk-po-
chg, ,
T=1h11m32.3: Synchronize startup config to u3
Flash Memory Write (8192 bytes per dot)
.

Write startup-config
done.

Config changed due to add/del units. Do write mem if you want to keep it
Stack unit 3 Power supply 1 is up
Stack unit 3 Power supply 2 is down
T=1h11m46.8: Election, was active, no change, ID=1, pri=128, 3U(1-3), A=u1, nbr#=2 2,

Config changed due to add/del units. Do write mem if you want to keep it

T=1h13m18.1: stack zero-touch configures multi-stack-trunk 1/2/1 to 1/2/3 and 2/2/1 to 2/2/3
stack-trunk 1/2/1 to 1/2/3 replaces stack-port 1/2/1 <-- New links between
stack-trunk 2/2/1 to 2/2/3 replaces stack-port 2/2/1 existing units
change configuration

Configuration changed. Please do "write memory".

Building a Stack

Stack construction methods

```
T=1h13m30.1: Election, was active, no change, ID=1, pri=128, 3U(1-3), A=u1, nbr#=2 2, reason: u1: stk-po-  
chg, ,
```

```
Config changed due to add/del units. Do write mem if you want to keep it
```

```
!!! Temperature is over warning level on stack unit 3 !!!
```

```
ICX7750-26Q Router#
```

```
ICX7750-26Q Router# show stack
```

```
T=1h15m2.1: alone: standalone, D: dynamic cfg, S: static  
ID Type Role Mac Address Pri State Comment  
1 S ICX7750-26QXG active cc4e.2438.7280 128 local Ready  
2 S ICX7750-48XGF standby 609c.9f7f.9400 128 remote Ready  
3 D ICX7750-26QXG member 748e.f8f9.6300 0 remote Ready
```

```
      active                standby  
      +----+                +----+  
=2/1| 1 |2/4==2/1| 3 |2/4==2/4| 2 |2/1=  
| +----+                +----+ |  
| +----+                +----+ |  
|-----|  
|-----|
```

```
Standby u2 - protocols ready, can failover or manually switch over  
Current stack management MAC is cc4e.2438.7280
```

```
ICX7750-26Q Router# show running-config
```

```
Current configuration:
```

```
!  
ver 08.0.90  
!  
stack unit 1  
  module 1 icx7750-20-qxg-port-management-module  
  module 2 icx7750-qsfp-6port-qsfp-240g-module  
  module 3 icx7750-6q-6port-qsfp-240g-module  
  priority 128  
  stack-trunk 1/2/1 to 1/2/3  
  stack-trunk 1/2/4 to 1/2/6  
stack unit 2  
  module 1 icx7750-48-xgf-port-management-module  
  module 2 icx7750-qsfp-6port-qsfp-240g-module  
  module 3 icx7750-6q-6port-qsfp-240g-module  
  priority 128  
  stack-trunk 2/2/1 to 2/2/3  
  stack-trunk 2/2/4 to 2/2/6  
stack unit 3  
  module 1 icx7750-20-qxg-port-management-module  
  module 2 icx7750-qsfp-6port-qsfp-240g-module  
  module 3 icx7750-6q-6port-qsfp-240g-module  
  stack-trunk 3/2/1 to 3/2/3  
  stack-trunk 3/2/4 to 3/2/6  
stack enable  
stack zero-touch-enable  
stack mac cc4e.2438.7280  
!
```

```
Unit 3 (new unit) log =====
```

```
ICX7750-26Q Router>
```

```
Creating certificate, please wait...
```

```
SSL Client Certificate is successfully created
```

```
Power supply 1 detected.
```

```
Power supply 1 is up.
```

```
Stack unit 1 Power supply 1 is up
```

```
Power supply 2 detected with no power.
```

```
!!! Temperature is over warning level on stack unit 1 !!!
```

```
!!! Temperature is over warning level on stack unit 1 !!!
```

```
!!! Temperature is over warning level on stack unit 1 !!!
```

```
!!! Temperature is over warning level on stack unit 1 !!!
Unit 1 receives stack zero-touch from U1, mac=cc4e.2438.7280 <-- Unit discovered & reloaded by unit 1
ID=3 D0=2/1 to 2/3, D1=2/4 to 2/6, , will reload from Primary in 20 sec
Unmounting the External USB
We are in system resetSyncing file system
Rebooting...

===== after bootup

The system : started=warm start   reloaded=by "reload"
My stack unit ID = 3, bootup role = member

[MEMBER]local-3@ICX7750-26Q Router>
Power supply 1  detected.
Power supply 1  is up.

Power supply 2  detected with no power.
UNIT3:
T=1m30.5: Election, was member, no change, ID=3, pri=0, 3U(1-3), A=u1, nbr#=2 0, reason: u3: port-up, ,
Unit 3 becomes ready
T=1m33.7: Election, was member, no change, ID=3, pri=0, 3U(1-3), A=u1, nbr#=2 0,
Download request from active unit 1 mac = cc4e.2438.7280

There is no startup config file, unable to save legacy config
Downloading - startup-config.txt
UNIT3:T=1m34.2: U3 received startup config flash sync.
Done.
T=1m41.1: Election, was member, no change, ID=3, pri=0, 3U(1-3), A=u1, nbr#=2 2,
UNIT3:
T=3m24.4: Election, was member, no change, ID=3, pri=0, 3U(1-3), A=u1, nbr#=2 2, reason: u1: stk-po-chg, ,
```

Scenario 3 - Manually configuring a three member stack in a ring topology

If you are connecting units that have been individually configured for stacking and want unit IDs to be assigned based on physical sequence, you may want to configure the stack manually.

Complete the following steps to configure a three-member stack in a ring topology using the manual configuration process. In this example, device 1 is the active controller, and device 2 is the standby controller. In this example, unit 3 boots up as a member, based on the configured priorities for units 1 and 2.

1. Power on the devices. Do not connect the stacking cables at this point.
2. Assign a priority of 255 to unit 1 and a priority of 240 to unit 2 using the **priority** command. You do not have to assign a priority to the third unit.

3. Enter the **stack enable** command on each device.

In this example, device 1 is the active controller, and device 2 is the standby controller.

Unit 1

```
device# configure terminal
device(config)# stack unit 1
device(config-unit-1)# priority 255
device(config-unit-1)# stack enable
Enable stacking. This unit actively participates in stacking
device(config-unit-1)# write memory
Write startup-config done.
Flash Memory Write (8192 bytes per dot) .Flash to Flash Done.
device(config-unit-1)# end
```

Unit 2

```
device# configure terminal
device(config)# stack suggested-id 2
device(config)# stack unit 1
device(config-unit-1)# priority 240
device(config-unit-1)# stack enable
Enable stacking. This unit actively participates in stacking
device(config-unit-1)# write memory
Write startup-config done.
Flash Memory Write (8192 bytes per dot) .Flash to Flash Done.
device(config-unit-1)# end
```

Unit 3

```
device# configure terminal
device(config)# stack suggested-id 3
device(config)# stack enable
Enable stacking. This unit actively participates in stacking
Write startup-config done.
Flash Memory Write (8192 bytes per dot) .Flash to Flash Done.
device(config-unit-1)# end
```

4. Connect the devices in a stack topology. The active controller retains its ID. The rest of the units are assigned unique ID numbers depending on the sequence in which you connected them.

For more information about cabling the devices, refer to the stacking overview for the device and the appropriate hardware installation guide.

NOTE

This method does not guarantee sequential stack IDs if you do not configure the optional **stack suggested-id** command on each standalone unit. If you want to change stack IDs to make them sequential, you can use `stack interactive-setup`. Refer to [Changing stack unit IDs with stack interactive-setup](#) on page 75.

NOTE

You can configure the **stack suggested-id** command in a standalone unit before using the **stack enable** command to cause the unit to join the stack. A unit is assigned the suggested ID if no other unit in the stack has that ID.

Verifying a stack configuration

Log in to the active controller and verify the stack information by entering the **show stack** or **show stack detail** commands. If the stack is configured properly, you should see the following:

- One active controller, one standby controller, and stack members
- All stack members with a status of Ready

The following output shows a sample configuration of a stack.

```
ICX7750-48F Router# show stack
T=9h56m55.9: alone: standalone, D: dynamic cfg, S: static
ID  Type      Role      Mac Address    Pri State  Comment
1   S ICX7750-48XGF active  609c.9f7f.9400 128 local  Ready
2   S ICX7750-20QXG standby 748e.f8f9.6300 128 remote Ready
3   S ICX7750-20QXG member  cc4e.2438.7280  0 remote Ready

      active      standby
      +----+      +----+      +----+
=2/1| 1 |2/4==2/4| 2 |2/1==2/4| 3 |2/1=
| +----+      +----+      +----+ |
|-----|
Standby u2 - protocols ready, can failover or manually switch over
Role history: N: standalone, A: active, S: standby, M: member
U1: M->S->A, U3: A->S->M

Current stack management MAC is 609c.9f7f.9400
ICX7750-48F Router#show running-config
Current configuration:
!
ver 08.0.90
!
stack unit 1
  module 1 icx7750-48-xgf-port-management-module
  module 2 icx7750-qsfp-6port-qsfp-240g-module
  module 3 icx7750-6q-6port-qsfp-240g-module
  priority 128
  stack-trunk 1/2/1 to 1/2/3
  stack-trunk 1/2/4 to 1/2/6
stack unit 2
  module 1 icx7750-20-qxg-port-management-module
  module 2 icx7750-qsfp-6port-qsfp-240g-module
  module 3 icx7750-6q-6port-qsfp-240g-module
  priority 128
  stack-trunk 2/2/1 to 2/2/3
  stack-trunk 2/2/4 to 2/2/6
stack unit 3
  module 1 icx7750-20-qxg-port-management-module
  module 2 icx7750-qsfp-6port-qsfp-240g-module
  module 3 icx7750-6q-6port-qsfp-240g-module
  stack-trunk 3/2/1 to 3/2/3
  stack-trunk 3/2/4 to 3/2/6
stack enable
stack mac 609c.9f7f.9400
!
```

The output from the **show stack** command contains a visual diagram of the stack. In the following example, the dashed line between ports 1/2/1 and 2/2/4 indicates that this stack is configured in a ring topology. The double dashed lines (equal signs) between all units indicate stack trunk connections. If a single dashed line were present, it would indicate a connection through a single stacking port.

```
      active      standby
      +----+      +----+      +----+
=2/1| 1 |2/4==2/4| 2 |2/1==2/4| 3 |2/1=
| +----+      +----+      +----+ |
|-----|
```

Building a Stack

Verifying a stack configuration

```
|-----|
```

If the link between ports 1/2/1 and 3/2/1 is lost, the stack topology changes to linear, and the diagram changes to resemble the following diagram.

```
active      standby
+---+      +---+      +---+
2/1| 1 |2/4==2/4| 2 |2/1==2/4| 3 |2/1
+---+      +---+      +---+
```

For more detailed information, you can enter the **show stack detail** command. The following example shows detailed information for a three-unit stack connected in a ring topology. Two of the units are connected by stack trunks.

```
ICX7750-26Q Router# show stack detail
T=18m33.4: alone: standalone, D: dynamic cfg, S: static
ID  Type      Role      Mac Address  Pri State  Comment
1   S ICX7750-26QXG active    748e.f8f9.6300  0 local  Ready
2   D ICX7750-26QXG member   cc4e.2438.7280  0 remote Ready
3   D ICX7750-26QXG standby  cc4e.2438.7500  0 remote Ready
```

```
active      standby
+---+      +---+      +---+
=2/1| 1 |2/4==2/1| 3 |2/4--2/1| 2 |2/4=
| +---+      +---+      +---+ |
|-----|
Will assign standby in 11 sec due to all ready
```

```
Standby u3 - protocols ready, can failover
Current stack management MAC is 748e.f8f9.6300
```

Image-Auto-Copy is Enabled.

Unit#	Stack-port1	Stack-port2	Neighbors	Stack-port2
1	up (1/2/1-1/2/2)	up (1/2/4-1/2/6)	U2 (2/2/4-2/2/5)	U3 (3/2/1-3/2/3)
2	up (2/2/1)	up (2/2/4-2/2/5)	U3 (3/2/4)	U1 (1/2/1-1/2/2)
3	up (3/2/1-3/2/3)	up (3/2/4)	U1 (1/2/4-1/2/6)	U2 (2/2/1)

```
Unit# System uptime
1      18 minute(s) 33 second(s)
2      17 minute(s) 30 second(s)
3      18 minute(s) 46 second(s)
```

To check the software version installed on each stack unit, enter the **show version** command. The software versions should match. If they do not match, refer to "Stack mismatches."

```
Copyright (c) Ruckus Networks, Inc. All rights reserved.
UNIT 1: compiled on Dec 20 2018 at 10:49:04 labeled as SWR08090dev
(30070372 bytes) from Primary SWR08090dev.bin
SW: Version 08.0.90devT203
Compressed Boot-Monitor Image size = 1835008, Version:10.1.12T205 (swz10112)
Compiled on Thu Jun 7 04:42:06 2018
UNIT 2: compiled on Dec 21 2018 at 16:38:54 labeled as SWR08090dev
(30066821 bytes) from Primary SWR08090dev.bin
SW: Version 08.0.90devT203
Compressed Boot-Monitor Image size = 1835008, Version:10.1.06T205 (swz10106b002)
UNIT 3: compiled on Dec 20 2018 at 10:49:04 labeled as SWR08090dev
(30070372 bytes) from Primary SWR08090dev.bin
SW: Version 08.0.90devT203
Compressed Boot-Monitor Image size = 1835008, Version:10.1.06T205 (swz10106b002)
```

NOTE

For field descriptions of the **show stack**, **show stack detail**, and **show version** commands, refer to “Displaying stack information.”

Displaying information on stack connections

You can check the data connections between stack units with the **show stack connection** command.

When the **show stack connection** command output includes the message ***** error: one-way**, this may indicate a stack port to non-stack-port connection. When this occurs, the side of the connection that is incorrectly configured as a stack port must be converted to a data port.

In the following example, the **show stack connection** command output indicates that CPU-to-CPU connections are working properly between all 12 members of the stack.

```
ICX7750-48F Router# show stack connection
Probing the topology. Please wait ...
ICX7750-48F Router#
  active
  +----+      +----+      +----+      +----+      +----+      +----+
-2/1| 1 |2/4--3/1| C |3/4==2/1| B |2/4==2/1| A |2/4--2/1| 9 |2/4--2/1| 8 |2/4-
| +----+      +----+      +----+      +----+      +----+      +----+ |
| |
| standby
| +----+      +----+      +----+      +----+      +----+      +----+ |
-2/4| 2 |2/1--2/4| 3 |2/1--2/4| 4 |2/1==2/4| 5 |2/1--2/4| 6 |2/1==2/4| 7 |2/1-
  +----+      +----+      +----+      +----+      +----+      +----+

trunk probe results: 12 links
Link 1: u1 -- u2, num=1
  1: 1/2/1 (P0) <----> 2/2/4 (P1)
Link 2: u1 -- u12, num=1
  1: 1/2/4 (P1) <----> 12/3/1 (P0)
Link 3: u2 -- u3, num=1
  1: 2/2/1 (P0) <----> 3/2/4 (P1)
Link 4: u3 -- u4, num=1
  1: 3/2/1 (P0) <----> 4/2/4 (P1)
Link 5: u4 -- u5, num=2
  1: 4/2/1 (T0) <----> 5/2/4 (T1)
  2: 4/2/2 (T0) <----> 5/2/5 (T1)
Link 6: u5 -- u6, num=1
  1: 5/2/1 (P0) <----> 6/2/4 (P1)
Link 7: u6 -- u7, num=3
  1: 6/2/1 (T0) <----> 7/2/4 (T1)
  2: 6/2/2 (T0) <----> 7/2/5 (T1)
  3: 6/2/3 (T0) <----> 7/2/6 (T1)
Link 8: u7 -- u8, num=1
  1: 7/2/1 (P0) <----> 8/2/4 (P1)
Link 9: u8 -- u9, num=1
  1: 8/2/1 (P0) <----> 9/2/4 (P1)
Link 10: u9 -- u10, num=1
  1: 9/2/1 (P0) <----> 10/2/4 (P1)
Link 11: u10 -- u11, num=2
  1: 10/2/1 (T0) <----> 11/2/4 (T1)
  2: 10/2/2 (T0) <----> 11/2/5 (T1)
Link 12: u11 -- u12, num=2
  1: 11/2/1 (T0) <----> 12/3/4 (T1)
  2: 11/2/2 (T0) <----> 12/3/5 (T1)
CPU to CPU packets are fine between 12 units.
```

Stacking by Device

- [ICX 7150 stack configuration overview](#)..... 89
- [ICX 7250 stack configuration overview](#)..... 102
- [ICX 7450 stack configuration overview](#)..... 107
- [ICX 7650 stack configuration overview](#)..... 117
- [ICX 7750 stack configuration overview](#)..... 136
- [ICX 7850 stack configuration overview](#)..... 150

ICX 7150 stack configuration overview

The following table provides an overview of ICX 7150 stacking capabilities.

TABLE 19 ICX 7150 stacking capabilities

Stacking capability	ICX 7150	Additional information
Topologies supported	Ring and linear	Refer to ICX 7150 stacking topologies on page 92.
Maximum stack size	12 units	Stacking and SPX configurations. Any combination of eligible ICX 7150 devices may be stacked. When a stand-alone ICX 7150 is configured as a PE unit attached to a control bridge in an 802.1br SPX configuration, scaling is increased. Refer to the <i>Ruckus FastIron Campus Fabric Configuration Guide</i> for more information.
Maximum stacking distance	10 Kilometers	Refer to FastIron stacking distances and optics by device on page 50 for more information.
Stacking ports	<p>Four 1-Gbps / 10-Gbps ports on fixed module on front panel that are available for stacking when configured for 10-Gbps operation.</p> <p>NOTE ICX 7150-C12P devices have two 1-Gbps / 10-Gbps ports that are available for stacking.</p>	<p>On most ICX 7150 models, module 3 on the front panel contains four ports that can be used as stacking or uplink ports.</p> <p>On ICX 7150-C12P devices, module 3 on the front panel contains two ports that can be used as stacking or uplink ports.</p> <p>On ICX 7150-48ZP devices, module 2 on the front panel contains four ports that can be used as stacking or uplink ports. Refer to ICX 7150 stacking topologies on page 92 for module and port locations.</p>
Valid-stack-port sets	<p>On most models, (x/3/1, x/3/3, 2).</p> <p>On ICX 7150-C12P devices, (x/3/1, x/3/2, 1).</p> <p>On ICX 7150-48ZP devices, (x/2/1, x/2/3, 2).</p> <p>NOTE The third number in the set is the maximum number of ports in a stacking trunk. One indicates stack-port only.</p>	<p>Refer to the definition of valid-stack-port set in Stacking terminology on page 19 and Valid-stack-port sets on page 23 for more information.</p> <p>Refer to ICX 7150 stacking topologies on page 92 for port locations.</p>

TABLE 19 ICX 7150 stacking capabilities (continued)

Stacking capability	ICX 7150	Additional information
Reconfigurable ports	Supported	Use the no stack-port command to reconfigure one stack port as a data uplink port. Once licensed, stacking ports will come up automatically as 10-Gbps. You can manually reconfigure 1-Gbps ports to licensed 10-Gbps ports and vice versa using the speed-duplex command. Refer to <i>Ruckus FastIron Software Licensing Guide</i> for information.
Stack trunks	Supported	Refer to ICX 7150 stacking trunks on page 96. ICX 7150-C12P devices do not support stacking trunks.
Linear-topology trunks	ICX7150-24P: stack-trunk x/3/1 to x/3/4 ICX7150-48P: no linear-topology trunk ICX7150-48ZP: stack-trunk x/2/1 to x/2/4 ICX7150-12C: stack-trunk x/3/1 to x/3/2	A linear-topology trunk is allowed only in a two-unit stack. It places the ports from both directions into one trunk. Refer to Support for two-unit stack linear-topology trunks on page 36 for more information.
Hitless switchover and hitless failover	Supported	Refer to Hitless stacking on page 171.
License requirements	A 10-Gbps license is required to support stacking, except on ICX 7150-48ZP devices.	Two 10-Gbps ports are standard on ICX 7150-48ZP devices, and any additional 10-Gbps ports require a license. On other ICX 7150 models, all 10-Gbps ports require a license. Licenses are available for additional 10-Gbps ports except on ICX 7150-C12P devices, which has only two available ports. Refer to the <i>Ruckus FastIron Software Licensing Guide</i> for information.
Configuration options	Manual and automatic, including interactive-setup and zero-touch provisioning	Refer to Stack construction methods on page 56.
Access methods	TFTP, SCP	Software images, boot images, and signatures can be downloaded to a stack using TFTP and SCP. Refer to the <i>Ruckus FastIron Software Upgrade Guide</i> for more information.
Stacking commands	All stacking CLI is available on the ICX 7150 unless otherwise noted on the command reference page.	

ICX 7150 stacking ports

Depending on the model, up to four SFP+ ports on the front panel of the ICX 7150 device support stacking. The ports can also be used as uplink (data) ports. The following figures show the location and numbering for stacking ports. The numbering for the ports is in three-tuple format (*x/y/z*) and refers to StackID/Slot/Port.

ICX 7150-C12P devices have two stacking ports on the front panel as shown in the following figure.

FIGURE 5 ICX 7150-C12P stacking ports

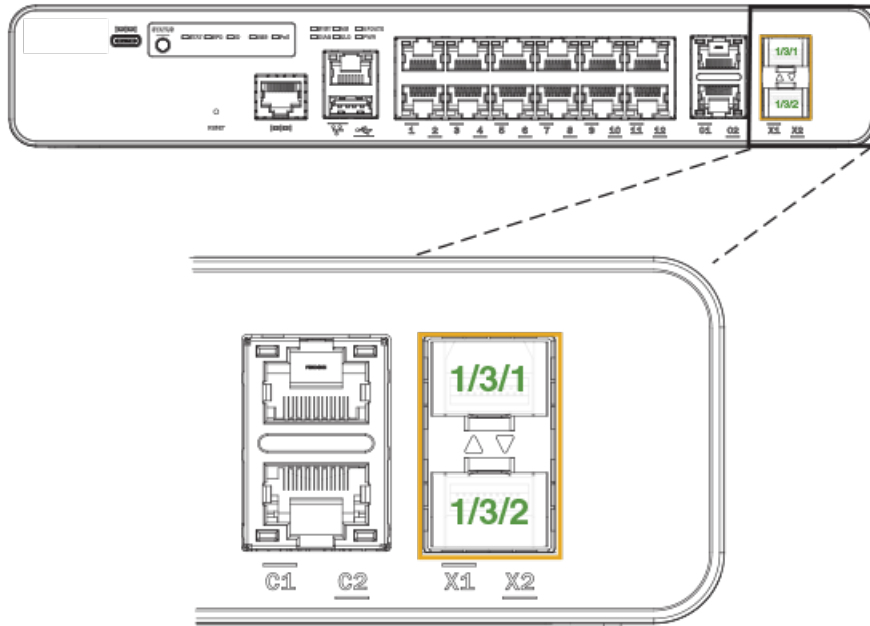

ICX 7150-24 and ICX 7150-24P devices have four stacking ports on the front panel as shown in the following figure.

FIGURE 6 ICX 7150 stacking port location on 24-port and some 48-port models

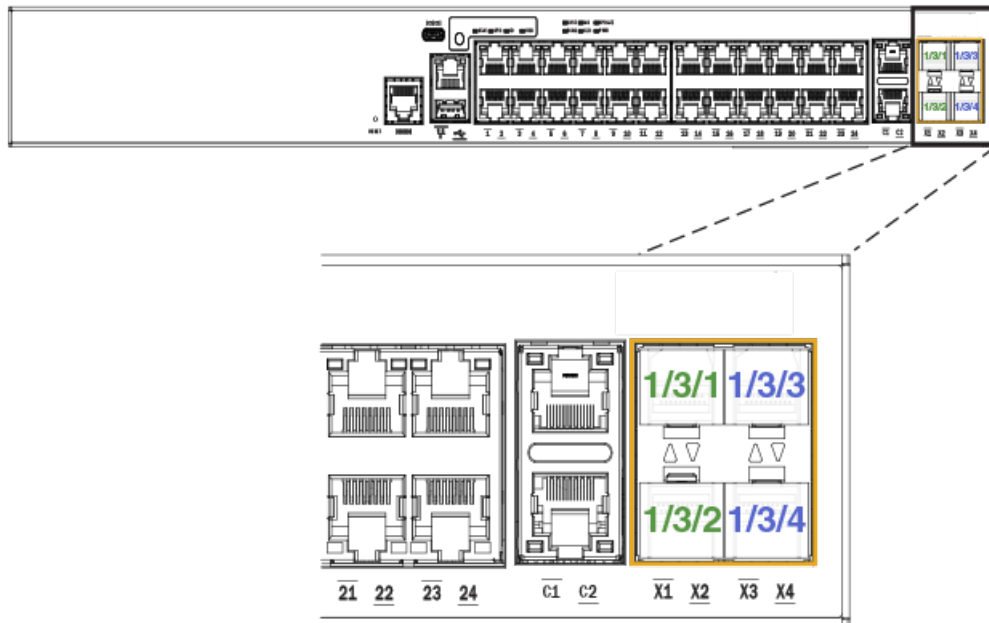

ICX 7150-48, ICX 7150-48P, and ICX 7150-48PF devices have four stacking ports in the same location on the front panel as ICX 7150 24-port models.

The exception among 48-port models is the ICX 7150-48ZP, which has eight SPF+ ports on the front panel as shown in the following figure. Four of these ports, ports 1/2/1 through 1/2/4, can be used as stacking or data uplink ports. The remaining four, 1/2/5 through 1/2/8, can be used only as data uplink ports.

FIGURE 7 ICX 7150-48ZP stacking ports

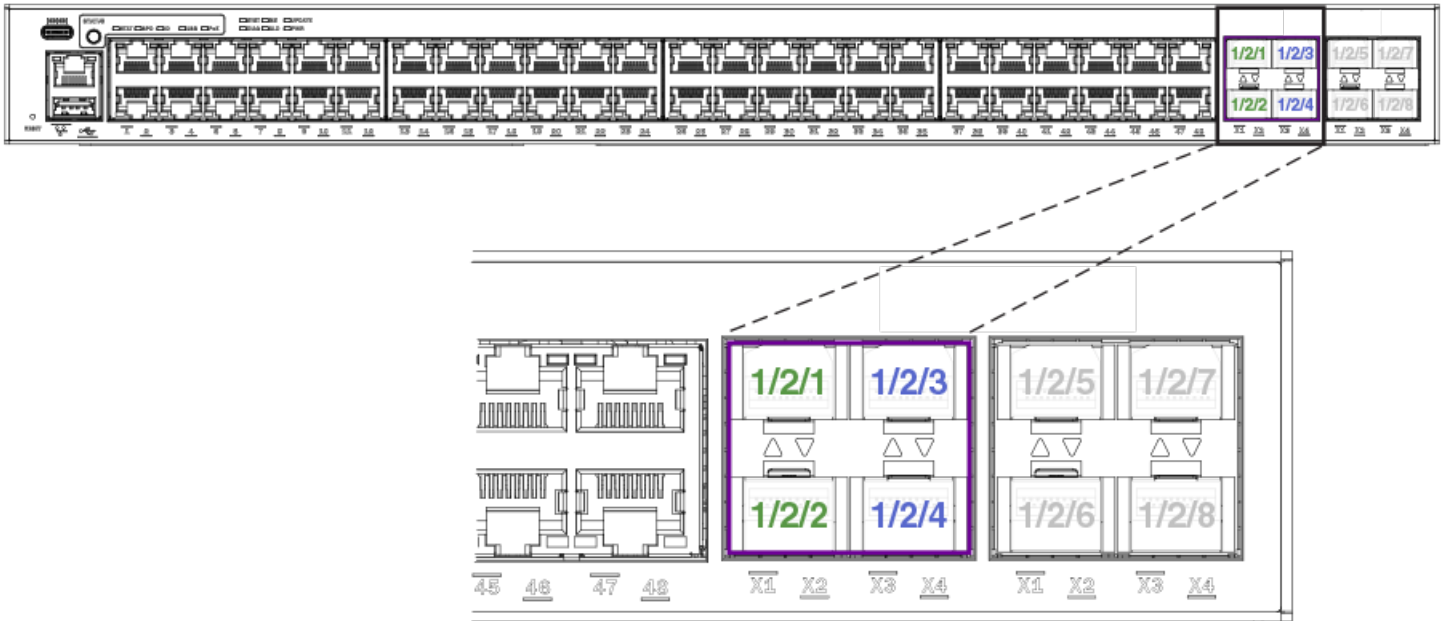

ICX 7150 stacking topologies

The stacks shown in the following figures show topologies that use only one stacking port per direction. For all models except the ICX 7150-C12P, it is possible to create a stacking trunk of two ports per direction to improve redundancy and bandwidth. For more information, refer to [ICX 7150 stacking trunks](#) on page 96.

The following figures show examples of supported stacking topologies for the ICX 7150-C12P.

FIGURE 8 ICX 7150-C12P linear stack



FIGURE 9 ICX 7150-C12P stack ring topology



The following figures show examples of supported topologies for ICX 7150 24-port models.

FIGURE 10 ICX 7150 24-port model, linear stack



FIGURE 11 ICX 7150 24-port stack ring topology



The following figures show examples of supported topologies for the ICX 7150-48ZP.

FIGURE 12 ICX 7150-48ZP linear stack

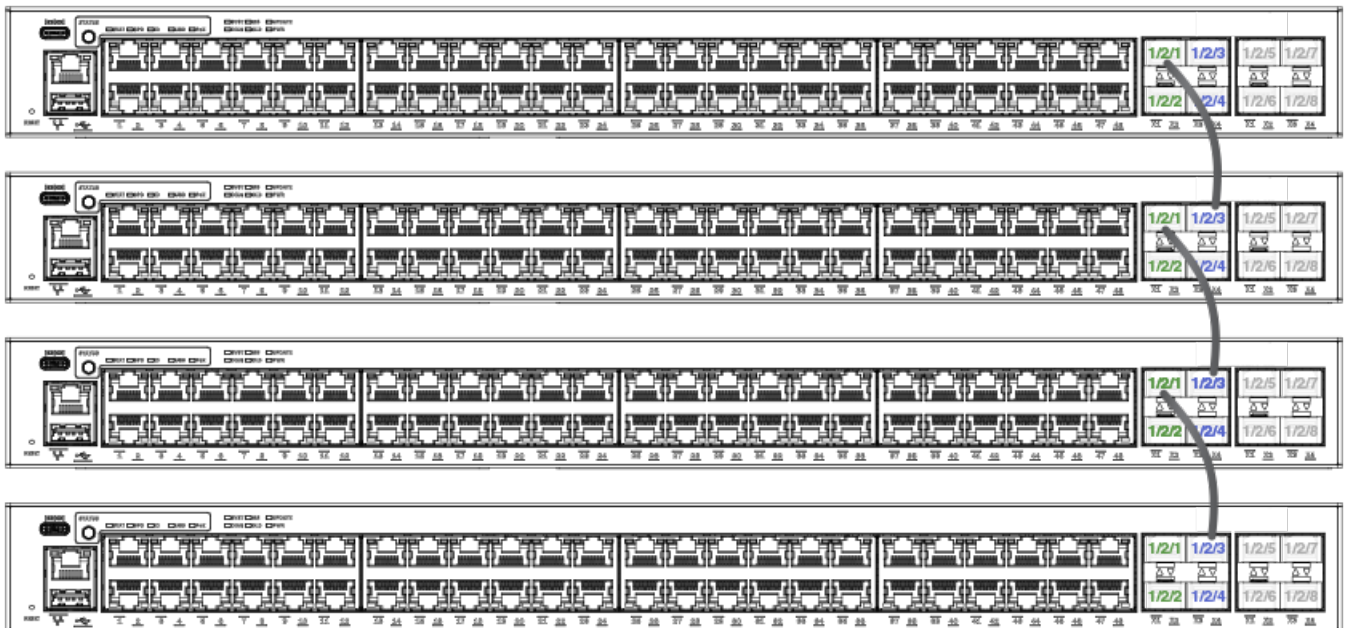
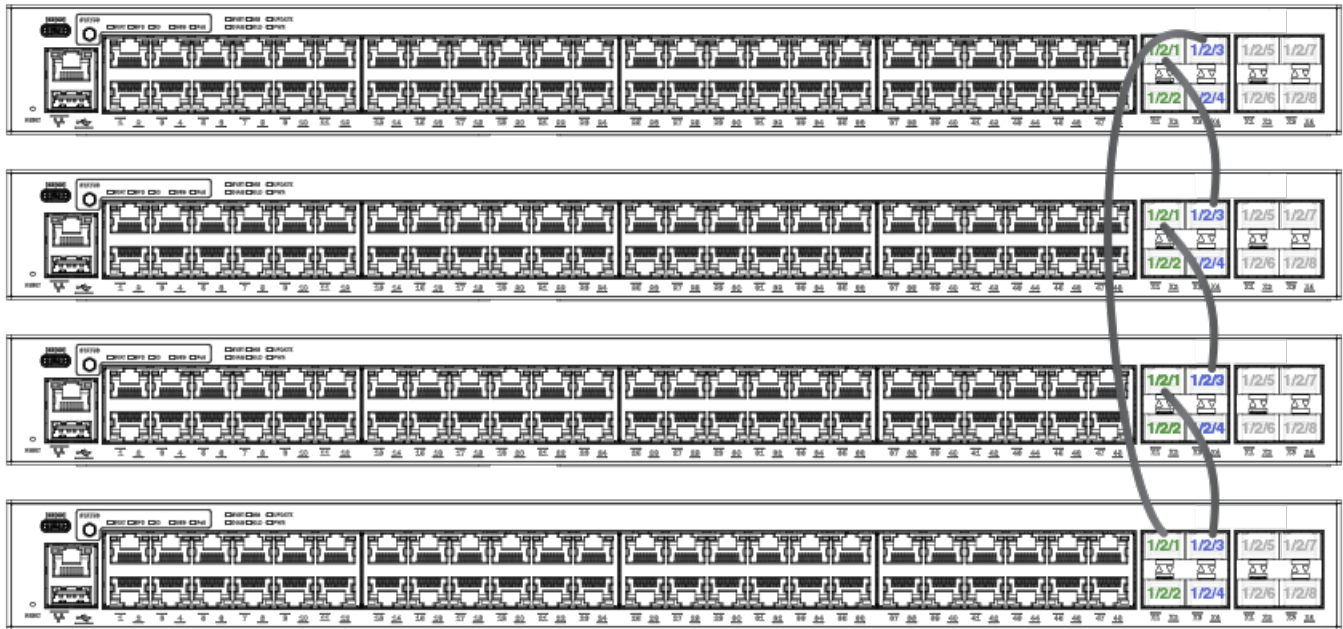
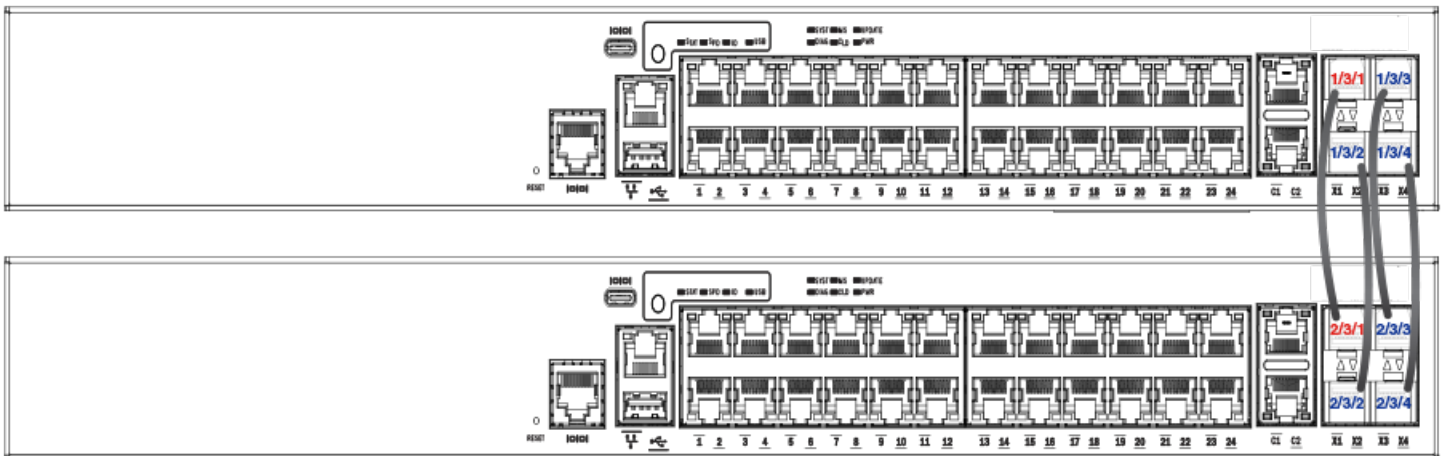

FIGURE 13 ICX 7150-48ZP stack ring topology



The following figure depicts a two-unit stack linear-topology trunk. All ICX 7150 models except for ICX 7150-12C devices support this type of trunk, which improves redundancy and bandwidth. For more information, refer to [Support for two-unit stack linear-topology trunks](#) on page 36.

FIGURE 14 ICX 7150 24-port two-unit stack with linear-topology trunk



ICX 7150 configuration notes

In ICX 7150 devices, the LAG hashing scheme is different from other ICX platforms. As a result, the user may observe uneven distribution of packets when the traffic pattern is sequential or incremental in the same step, for example, when both the source and the destination IP address are incremented in the same step.

ICX 7150 stacking trunks

All ports on both ends of a trunk must be configured at the same speed. The lead port in a stacking trunk must be a valid-stack-port. The default valid-stack-ports come up automatically as 10-Gbps ports (assuming they are licensed). Additional 10-Gbps ports require a license.

NOTE

Two 10-Gbps stacking ports are standard on ICX 7150-48ZP devices.

Stacking trunks can be configured as part of the stack interactive-setup process. Trunks can also be added when a link is down or on a production unit as described later in this section.

The following table lists ports that can be combined as stacking trunks. Refer to [Support for two-unit stack linear-topology trunks](#) on page 36 for more information on linear-topology trunks.

TABLE 20 ICX 7150 stacking trunk options

Model	Valid-stack-ports	Additional stacking ports	Two-port trunks	Linear-topology trunks
ICX 7150-C12P	1/3/1, 1/3/2	None	Not supported	stack-trunk 1/3/1 to 1/3/2
ICX 7150-24	1/3/1, 1/3/3	1/3/2, 1/3/4	1/3/1-1/3/2, 1/3/3-1/3/4	stack-trunk 1/3/1 to 1/3/4
ICX 7150-24P				
ICX 7150-48	1/3/1, 1/3/3	1/3/2, 1/3/4	1/3/1-1/3/2, 1/3/3-1/3/4	Not supported
ICX 7150-48P				
ICX 7150-48PF				
ICX 7150-48ZP	1/2/1, 1/2/3	1/2/2, 1/2/4	1/2/1-1/2/2, 1/2/3-1/2/4	stack-trunk 1/2/1 to 1/2/4

Creating ICX 7150 stacking trunks while the link is down

Follow these steps to create a trunk while the link is down.

NOTE

Use the **stack-port** command while the link is down to remove stacking trunks and restore individual stacking ports.

1. Enter global configuration mode.

```
ICX7150-24 Router(config)# configure terminal
```

2. (Optional) Use the **show stack** command to check the stack topology and status.

```
ICX7150-24 Router(config)# show stack
T=36m46.7: alone: standalone, D: dynamic cfg, S: static
ID  Type      Role      Mac Address  Pri State  Comment
1   S ICX7150-24  active  00e0.5200.0100 128 local  Ready
2   S ICX7150-48P  standby 748e.f882.e418 0 remote Ready

      standby      active
      +----+      +----+
      3/3| 2 |3/1==3/1| 1 |3/3
      +----+      +----+
Will assign standby in 56 sec due to all ready

Standby u2 - protocols ready, can failover
Current stack management MAC is 00e0.5200.0100
```

The example shows a two-unit stack with both units in the Ready state. The units are connected by a trunk through stack ports 1/3/1 and 2/3/1.

3. Enter stack unit configuration mode on the active controller.

```
ICX7150-24 Router(config)# stack unit 1
ICX7150-24 Router(config-unit-1)#
```

4. Enter the **stack-trunk** command followed by the range of ports to include in the trunk.

```
ICX7150-24 Router(config-unit-1)# stack-trunk 1/3/3 to 1/3/4
```

The example creates a two-port stacking trunk containing ports 1/3/3 and 1/3/4.

5. Create a stacking trunk for the same number of ports at the other end of the planned connection if the trunk has not been created.

```
ICX7150-24 Router(config-unit-1)# stack-trunk 2/3/3 to 2/3/4
```

The example creates a stacking trunk from ports 2/3/3 and 2/3/4.

6. (Optional) Enter the **show running-config** command to check the configuration.

```
ICX7150-24 Router(config-unit-1)# show running-config
Current configuration:
!
ver 08.0.90
!
stack unit 1
  module 1 icx7150-24-port-management-module
  module 2 icx7150-2-copper-port-2g-module
  module 3 icx7150-4-sfp-plus-port-40g-module
  priority 128
  stack-trunk 1/3/1 to 1/3/2
  stack-trunk 1/3/3 to 1/3/4
stack unit 2
  module 1 icx7150-48p-poe-port-management-module
  module 2 icx7150-2-copper-port-2g-module
  module 3 icx7150-4-sfp-plus-port-40g-module
  stack-trunk 2/3/1 to 2/3/2
  stack-trunk 2/3/3 to 2/3/4
stack enable
stack mac 00e0.5200.0100
!
!
end
```

The example shows the stack with the existing trunk (1/3/1 to 1/3/2 connected to 2/3/1 to 2/3/2) and the trunk added on stack unit 1 and stack unit 2. To create a ring topology, the new trunk on the two stack units could be connected physically.

Stacking by Device

ICX 7150 stack configuration overview

The following example creates a trunk on stack unit 1 while the link is down.

```
ICX7150-24 Router(config)# configure terminal
ICX7150-24 Router(config)# show stack
T=36m46.7: alone: standalone, D: dynamic cfg, S: static
ID  Type      Role      Mac Address  Pri State  Comment
1   S ICX7150-24  active 00e0.5200.0100 128 local  Ready
2   S ICX7150-48P standby 748e.f882.e418 0 remote Ready

      standby      active
      +----+      +----+
3/3| 2 |3/1==3/1| 1 |3/3
      +----+      +----+
Will assign standby in 56 sec due to all ready

Standby u2 - protocols ready, can failover
Current stack management MAC is 00e0.5200.0100
ICX7150-24 Router(config)#Debug: Jan 1 00:38:24
Config changed due to add/del units. Do write mem if you want to keep it

ICX7150-24 Router(config)# stack unit 1
ICX7150-24 Router(config-unit-1)# stack-trunk 1/3/3 to 1/3/4
ICX7150-24 Router(config-unit-1)# show stack
T=40m31.8: alone: standalone, D: dynamic cfg, S: static
ID  Type      Role      Mac Address  Pri State  Comment
1   S ICX7150-24  active 00e0.5200.0100 128 local  Ready
2   S ICX7150-48P standby 748e.f882.e418 0 remote Ready

      standby      active
      +----+      +----+
3/3| 2 |3/1==3/1| 1 |3/3
      +----+      +----+
Standby u2 - protocols ready, can failover
Current stack management MAC is 00e0.5200.0100
ICX7150-24 Router(config-unit-1)# show running-config
Current configuration:
!
ver 08.0.90
!
stack unit 1
  module 1 icx7150-24-port-management-module
  module 2 icx7150-2-copper-port-2g-module
  module 3 icx7150-4-sfp-plus-port-40g-module
  priority 128
  stack-trunk 1/3/1 to 1/3/2
  stack-trunk 1/3/3 to 1/3/4
stack unit 2
  module 1 icx7150-48p-poe-port-management-module
  module 2 icx7150-2-copper-port-2g-module
  module 3 icx7150-4-sfp-plus-port-40g-module
  stack-trunk 2/3/1 to 2/3/2
  stack-port 2/3/3
stack enable
stack mac 00e0.5200.0100
!
!
end
```

Creating ICX 7150 stacking trunks on a live system

Follow these steps to create a trunk on a live system.

NOTE

Use the **multi-stack-port** command to remove stacking trunks and restore stacking ports on a live system.

1. Enter global configuration mode.

```
ICX7150-24 Router(config)# configure terminal
```

2. (Optional) Use the **show stack** command to check the stack topology and status.

```
ICX7150-24 Router(config-unit-1)# show stack
T=35m51.5: alone: standalone, D: dynamic cfg, S: static
ID  Type      Role      Mac Address  Pri State  Comment
1   S ICX7150-24  active      00e0.5200.0100 128 local  Ready
2   S ICX7150-48P standby     748e.f882.e418  0 remote Ready
3   D ICX7150-24P member      cc4e.24b4.729c  0 remote Ready

      active                standby
      +---+                +---+
-3/1| 1 |3/3==3/3| 3 |3/1--3/3| 2 |3/1-
| +---+                +---+
|
|-----|
Will assign standby in 56 sec due to all ready

Standby u2 - protocols ready, can failover
Current stack management MAC is 00e0.5200.0100
```

The example shows a three-unit stack with all units in the Ready state. The units are connected in a ring formation, but there is no trunk between units 1 and 2. The trunk is formed in the following steps.

3. Enter stack unit configuration mode.

```
ICX7150-24 Router(config)# stack unit 1
ICX7150-24 Router(config-unit-1)#
```

4. Enter the **multi-stack-trunk** command followed by the range of ports to include in the trunk on the connecting stack units.

```
ICX7150-24 Router(config-unit-1)# multi-stack-trunk 1/3/1 to 1/3/2 and 2/3/1 to 2/3/2
```

The example creates a two-port stacking trunk containing ports 1/3/1 and 1/3/2 on stack unit 1 and ports 2/3/1 and 2/3/2 on stack unit 2.

Stacking by Device

ICX 7150 stack configuration overview

- (Optional) Enter the **show stack** command and the **show stack connection** command to check the configuration.

```
ICX7150-24 Router(config-unit-1)# show stack
T=35m51.5: alone: standalone, D: dynamic cfg, S: static
ID   Type           Role      Mac Address      Pri State  Comment
1   S ICX7150-24     active    00e0.5200.0100  128 local  Ready
2   S ICX7150-48P   standby  748e.f882.e418   0  remote Ready
3   D ICX7150-24P   member    cc4e.24b4.729c   0  remote Ready
```

```

      active                standby
      +----+                +----+
=3/1| 1 |3/3==3/3| 3 |3/1--3/3| 2 |3/1=
|  +----+                +----+ |
|-----|
Will assign standby in 56 sec due to all ready
```

```
Standby u2 - protocols ready, can failover
Current stack management MAC is 00e0.5200.0100
```

```
ICX7150-24 Router# show stack connection
Probing the topology. Please wait ...
ICX7150-24 Router#
```

```

      active                standby
      +----+                +----+
=3/1| 1 |3/3==3/3| 3 |3/1--3/3| 2 |3/1=
|  +----+                +----+ |
|-----|
```

```
trunk probe results: 3 links
Link 1: u1 -- u2, num=1
  1: 1/3/1 (T0) <----> 2/3/1 (T0)
  2: 1/3/2 (T0) <----> 2/3/2 (T0)
Link 2: u1 -- u3, num=2
  1: 1/3/3 (T1) <----> 3/3/3 (T1)
  2: 1/3/4 (T1) <----> 3/3/4 (T1)
Link 3: u2 -- u3, num=1
  1: 2/3/3 (P1) <----> 3/3/1 (P0)
CPU to CPU packets are fine between 3 units.
```

The example shows the stack with the added trunk forming a ring through stacking ports 1/3/1 to 1/3/2 and 2/3/1 to 2/3/2.

The following example creates a trunk on a live link.

```
ICX7150-24 Router# configure terminal
ICX7150-24 Router(config)# stack unit 1
ICX7150-24 Router(config-unit-1)# multi-stack-trunk 1/3/1 to 1/3/2 and 2/3/1 to 2/3/2
```

```
ICX7150-24 Router(config-unit-1)# show stack
T=35m51.5: alone: standalone, D: dynamic cfg, S: static
ID  Type           Role      Mac Address   Pri State  Comment
1   S ICX7150-24      active    00e0.5200.0100 128 local  Ready
2   S ICX7150-48P     standby  748e.f882.e418  0 remote Ready
3   D ICX7150-24P     member   cc4e.24b4.729c  0 remote Ready
```

```

      active                               standby
      +----+                               +----+
=3/1| 1 |3/3==3/3| 3 |3/1--3/3| 2 |3/1=
| +----+                               +----+ |
|-----|
Will assign standby in 56 sec due to all ready

```

```
Standby u2 - protocols ready, can failover
Current stack management MAC is 00e0.5200.0100
```

```
ICX7150-24 Router# show stack connection
Probing the topology. Please wait ...
ICX7150-24 Router#
```

```

      active                               standby
      +----+                               +----+
=3/1| 1 |3/3==3/3| 3 |3/1--3/3| 2 |3/1=
| +----+                               +----+ |
|-----|

```

```
trunk probe results: 3 links
Link 1: u1 -- u2, num=1
  1: 1/3/1 (T0) <----> 2/3/1 (T0)
  2: 1/3/2 (T0) <----> 2/3/2 (T0)
Link 2: u1 -- u3, num=2
  1: 1/3/3 (T1) <----> 3/3/3 (T1)
  2: 1/3/4 (T1) <----> 3/3/4 (T1)
Link 3: u2 -- u3, num=1
  1: 2/3/3 (P1) <----> 3/3/1 (P0)
CPU to CPU packets are fine between 3 units.
```

Converting stacking ports to data ports on ICX 7150 devices

Follow these steps to convert a stacking port to a data port on an ICX 7150 device.

1. Enter global configuration mode.

```
ICX7150-24 Router# configure terminal
```

2. Enter configuration mode for the stack unit.

```
ICX7150-24 Router(config)# stack unit 1
ICX7150-24 Router(config-unit-1)#
```

The example enters configuration mode on stack unit 1.

3. Use the **no stack-port** command to remove stacking from one stacking port to convert it to a data port.

```
ICX7150-24 Router(config-unit-1)# no stack-port 1/3/3
stack-port 1/3/3 is removed.
```

Stacking by Device

ICX 7250 stack configuration overview

The following example converts stacking port 1/3/3 to a data port.

```
ICX7150-24 Router# configure terminal
ICX7150-24 Router(config)# stack unit 1
ICX7150-24 Router(config-unit-1)# no stack-port 1/3/3
stack-port 1/3/3 is removed.

ICX7150-24 Router(config-unit-1)# show stack
T=4lm15.7: alone: standalone, D: dynamic cfg, S: static
ID  Type      Role      Mac Address  Pri State  Comment
1   S ICX7150-24  active  00e0.5200.0100 128 local  Ready
2   S ICX7150-48P standby 748e.f882.e418 0 remote Ready

      standby      active
      +----+      +----+
3/3| 2 |3/1==3/1| 1 |
      +----+      +----+
Will assign standby in 58 sec due to all ready

Standby u2 - protocols ready, can failover
Current stack management MAC is 00e0.5200.0100
```

ICX 7250 stack configuration overview

The following table provides an overview of ICX 7250 stacking capabilities.

TABLE 21 ICX 7250 stacking capability

Stacking capability	ICX 7250	Additional information
Topologies supported	Ring and linear	Refer to ICX 7250 stacking topologies on page 103.
Maximum stack size	12 units	Stacking and SPX configurations. Any combination of ICX 7250 devices may be stacked. When a stand-alone ICX 7250 is configured as a PE unit attached to a control bridge in an 802.1br SPX configuration, scaling is increased. Refer to the <i>Ruckus FastIron Campus Fabric Configuration Guide</i> for more information.
Maximum stacking distance	10 Kilometers	Refer to FastIron stacking distances and optics by device on page 50 for more information.
Stacking ports	Four 10-Gbps stacking ports (from eight available ports) on fixed module on front panel	Module 2 on the front panel contains four stacking ports and four uplink ports, which can be used as alternative ports for stacking. Refer to ICX 7250 stacking topologies on page 103 for module and port locations.
Valid-stack-port sets	Factory set (x/2/1, x/2/3, 2) or (x/2/5, x/2/7, 2) NOTE The third number in each set is the maximum number of ports in a stacking trunk.	Refer to the definition of valid-stack-port set in Stacking terminology on page 19 and Valid-stack-port sets on page 23 for more information. Refer to ICX 7250 stacking topologies on page 103 for port locations.

TABLE 21 ICX 7250 stacking capability (continued)

Stacking capability	ICX 7250	Additional information
Reconfigurable ports	Supported	Use the stack-port command to reconfigure one stack port as a data uplink port. Once licensed, stacking ports come up as 10-Gbps ports automatically. You can manually reconfigure 1-Gbps ports to 10-Gbps ports when licensed using the speed-duplex command.
Stack trunks	stack-trunk 1/2/1 to 1/2/2 stack-trunk 1/2/3 to 1/2/4 stack-trunk 1/2/5 to 1/2/6 stack-trunk 1/2/7 to 1/2/8	Refer to ICX 7250 trunk configuration on page 106.
Linear-topology trunks	stack-trunk x/2/1 to x/2/4 or stack-trunk x/2/5 to x/2/8	Refer to Support for two-unit stack linear-topology trunks on page 36 for more information.
Hitless switchover and hitless failover	Supported	Refer to Hitless stacking on page 171.
License requirements	A license is required for 10-Gbps ports. (Trunks cannot be formed with the pre-installed two-port license.)	The pre-installed license is for two 10-Gbps ports (supports stacking ports 1/2/1 and 1/2/3). Licenses are available for eight 10-Gbps ports. Refer to the <i>Ruckus FastIron Software Licensing Guide</i> for information.
Configuration options	Manual and automatic, including interactive-setup and zero-touch provisioning	Refer to Stack construction methods on page 56.
Access methods	TFTP, SCP	Software images, boot images, and signatures can be downloaded to a stack using TFTP and SCP. Refer to the <i>Ruckus FastIron Software Upgrade Guide</i> for more information.
Stacking commands	All stacking CLI is available on the ICX 7250 unless otherwise noted on the command reference page.	

ICX 7250 stacking topologies

Up to 12 ICX 7250-24, ICX 7250-24P, ICX 7250-48, or ICX 7250-48P units can be connected in a linear or ring topology. Any of these models can be mixed in the same stack. Stacking ports are located on the front panel as shown in the following figures.

NOTE

The ICX 7250-24G is not stackable.

From one to four 10-Gbps ports (from eight available 10-Gbps ports) can be used for stacking on the ICX 7250. All stacking ports must have an active license installed to be properly configured. Active stacking ports can be configured in one of two sets of ports on the front panel; however, stacking ports cannot be mixed between the two sets of ports because of operational constraints. Available ports are numbered 1/2/1 through 1/2/8 as shown in the following figure.

FIGURE 15 ICX 7250 stacking ports

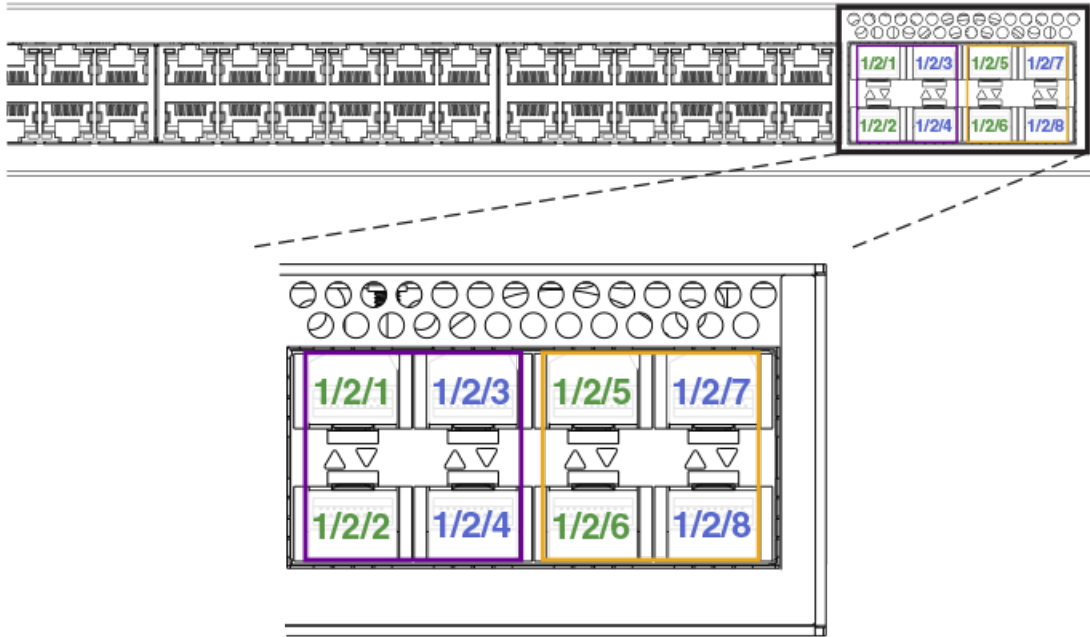

The following figures show ICX 7250 units connected in a linear stack and a ring stack.

FIGURE 16 ICX 7250-24P linear stack

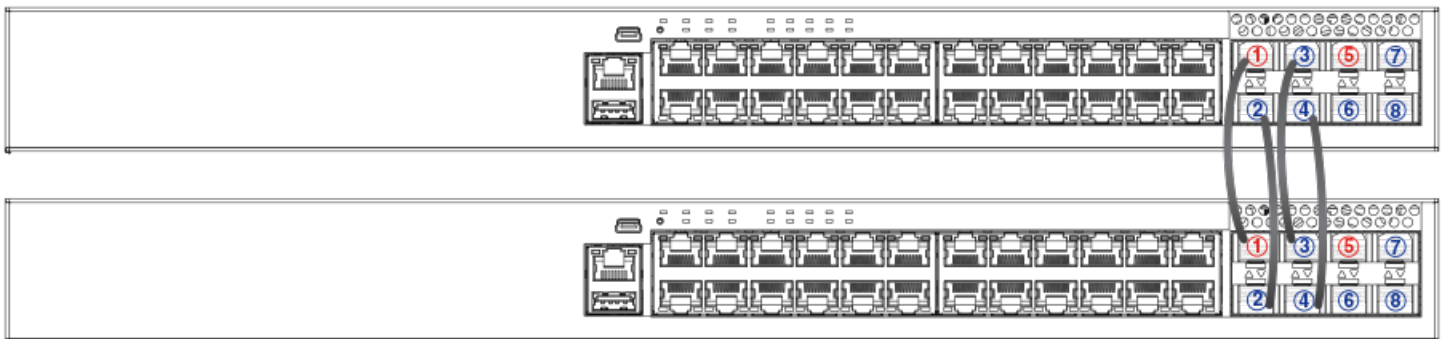

FIGURE 17 ICX 7250-24P ring stack



The following figure depicts a two-unit stack linear-topology trunk. All ICX 7250 models support this type of trunk, which improves redundancy and bandwidth. For more information, refer to [Support for two-unit stack linear-topology trunks](#) on page 36.

FIGURE 18 ICX 7250-24P two-unit stack with linear-topology trunk



ICX 7250 stacking configuration notes

All ICX 7250 platforms except the ICX 7250-24G support stacking on 10-Gbps links. The ICX 7250 requires a license for ports to operate at 10 Gbps. Otherwise, the ports support only 1 Gbps. These 1-Gbps ports do not support stacking.

If a port is configured to operate at 1 Gbps in the startup configuration, it would continue to operate at 1 Gbps after a license is installed, unless it is re-configured to operate at 10 Gbps. Refer to [Reconfiguring ICX 7250 1-Gbps ports as 10-Gbps ports](#) on page 106. However, if no user configuration is present for the ports, they will automatically be configured as 10-Gbps ports when a license is installed.

If an ICX 7250 stack is formed on licensed ports and the license is later removed, the stack breaks after reload because the stack ports return to 1-Gbps mode. To form the stack again, the license must be downloaded to each device.

Of the eight 10-Gbps SFP+ ports potentially available on the ICX 7250 as stacking or uplink ports, a maximum of four ports can be used simultaneously for stacking. These ports can operate as separate ports, or they can be configured as two-port trunks. Refer

to [ICX 7250 trunk configuration](#) on page 106 for more information. All eight ports are available as uplink data ports when not used for stacking.

When stacking is configured, all stack ports and trunks must be either in the port range of 1/2/1 through 1/2/4 or in the port range 1/2/5 through 1/2/8. Ports 1/2/1 through 1/2/8 support both active cables and 10-Gbps SFP+ optics. Ports 1/2/5 through 1/2/8 have re-timers that support active cables. Any of these ports can be used for long-distance stacking if appropriate SFP's and cables are used. When any units in the stack are cross-cabled to a unit with stacking on ports 1/2/1 through 1/2/4, active cables should be used throughout the stack.

Reconfiguring ICX 7250 1-Gbps ports as 10-Gbps ports

A port previously configured as a 1-Gbps port must be reconfigured to operate at 10 Gbps. Stacking on the ICX 7250 is only available on 10-Gbps ports in module 2.

NOTE

A license is required for 10-Gbps ports on the ICX 7250. Refer to the *Ruckus FastIron Software Licensing Guide* for additional information.

NOTE

Once a 10-Gbps port license is installed, previously unconfigured ports that are covered by the license come up automatically as 10-Gbps ports. Ports must then be configured for stacking. Refer to [ICX 7250 stacking configuration notes](#) on page 105.

Use the **speed-duplex** command to reconfigure port speed on a 1-Gbps port.

In the following example, port 1/2/1, a 1-Gbps port, is reconfigured as a 10-Gbps port.

```
ICX7250-48P Router# configure terminal
ICX7250-48P Router(config)# interface ethernet 1/2/1
ICX7250-48P Router(config-if-e10000-1/2/1)# speed-duplex 10g-full
```

ICX 7250 trunk configuration

When a 10G-port license is installed, two stacking trunks containing two ports each can be configured on each ICX 7250 unit.

Stacked trunks can be formed using the following port combinations:

- Stack ports 1/2/1 and 1/2/2
- Stack ports 1/2/3 and 1/2/4
- Stack ports 1/2/5 and 1/2/6
- Stack ports 1/2/7 and 1/2/8

Two-unit linear-topology trunks can be formed using the following port combinations:

- Stack ports 1/2/1 to 1/2/4
- Stack ports 1/2/5 to 1/2/8

Refer to [Support for two-unit stack linear-topology trunks](#) on page 36 for more information.

The following example designates ports 1/2/1 and 1/2/3 as the valid-stack-port set to be used and creates two trunks.

```
ICX7250-24P Router(config)# stack unit 1
ICX7250-24P Router(config-unit-1)# stack-trunk 1/2/1 to 1/2/2
ICX7250-24P Router(config-unit-1)# stack-trunk 1/2/3 to 1/2/4
```

The following example uses the other valid-stack-port set (1/2/5, 1/2/7).

```
ICX7250-24P Router(config)# stack unit 1
ICX7250-24P Router(config-unit-1)# stack-trunk 1/2/5 to 1/2/6
ICX7250-24P Router(config-unit-1)# stack-trunk 1/2/7 to 1/2/8
```

The following example creates a linear-topology trunk containing ports 1/2/1 through 1/2/4:

```
ICX7250-24P Router(config)# stack unit 1
ICX7250-24P Router(config-unit-1)# stack-trunk 1/2/1 to 1/2/4
```

The following example creates a linear-topology trunk containing ports 1/2/5 through 1/2/8:

```
ICX7250-24P Router(config)# stack unit 1
ICX7250-24P Router(config-unit-1)# stack-trunk 1/2/5 to 1/2/8
```

Creating ICX 7250 trunks in a production environment

The **stack-trunk** command cannot be used in a live environment. Instead, use the **multi-stack-trunk** command to configure both ends of a trunk simultaneously.

The following example creates a multi-stack-trunk cross-cabled connection between unit 1 and unit 2 on ports 1/2/7 through 1/2/8 and ports 2/2/5 through 2/2/6.

```
ICX7250-48 Router(config-unit-1)# multi-stack-trunk 1/2/7 to 1/2/8 and 2/2/5 to 2/2/6
```

```
ICX7250-48 Router(config-unit-1)# show stack
T=15d23h18m0.7: alone: standalone, D: dynamic cfg, S: static
ID  Type      Role  Mac Address  Pri State  Comment
1   S ICX7250-48  active cc4e.24b4.23e8  0 local  Ready
2   S ICX7250-24P member cc4e.24b4.8aa8  0 remote Ready
3   S ICX7250-24  standby cc4e.24b4.8cc4  0 remote Ready
4   S ICX7250-48P member cc4e.24b4.2d84  0 remote Ready

      active                                standby
      +----+                                +----+
=2/5| 1 |2/7==2/5| 2 |2/7--2/5| 4 |2/7--2/5| 3 |2/7=
|   +----+                                +----+   |
|-----|-----|-----|-----|-----|
Standby u3 - protocols ready, can failover or manually switch over
Current stack management MAC is cc4e.24b4.23e8
```

The double lines between unit 1 and unit 2 in the previous output indicate a trunk connection with two ports from each unit.

ICX 7450 stack configuration overview

The following table provides an overview of ICX 7450 stacking capabilities. From FastIron release 08.0.30, 4 x 10-Gbps stacking is available from module 2 as an option.

TABLE 22 ICX 7450 stacking capability

Stacking capability	ICX 7450	Additional information
Topologies supported	Ring and linear	Refer to ICX 7450 stacking topologies on page 109.

TABLE 22 ICX 7450 stacking capability (continued)

Stacking capability	ICX 7450	Additional information
Maximum stack size	12 units	Stacking and SPX configurations. Any combination of ICX 7450 devices may be stacked. When a stand-alone ICX 7450 is configured as a PE unit attached to a control bridge in an 802.1br SPX configuration, scaling is increased. Refer to the <i>Ruckus FastIron Campus Fabric Configuration Guide</i> for more information.
Maximum stacking distance	100 meters, 300 meters, or 10 kilometers, depending on optic	Refer to FastIron stacking distances and optics by device on page 50 for more information.
Stacking ports	Two 40-Gbps ports in rear or 4 X 10-Gbps ports as an option on front NOTE 40-Gbps stacking and 4 X 10-Gbps stacking cannot be used simultaneously in the same stack. NOTE Changing stacking ports from Modules 3 and 4 to Module 2 ports requires write memory and reload .	Modules 3 and 4, one port each. Four 10-Gbps ports are available as an option when a 4X10GF module is installed in slot 2. Refer to ICX 7450 stacking topologies on page 109 for module locations.
Valid-stack-port sets	Factory set (x/3/1, x/4/1, 1) or (x/2/1, x/2/3, 2) NOTE The third number of a set is the maximum number of ports in a stacking trunk. One indicates stack-port only.	Refer to the definition of valid-stack-port set in Stacking terminology on page 19 and Valid-stack-port sets on page 23 for more information. Refer to ICX 7450 stacking topologies on page 109 for port locations.
Reconfigurable ports	Use the stack-port and stack-trunk commands to reconfigure ports.	Stacking ports can be reconfigured as data ports. Refer to Configuring 10 Gbps stacking ports on the ICX 7450 on page 113 for more information. Refer to Planning to build a stack with 802.1br switch port extender capability on page 55 for more information about configuring ICX 7450 devices in an SPX configuration.
Stack trunks	Two trunks are possible: 1/2/1 to 1/2/2 and 1/2/3 to 1/2/4	Supported on 10-Gbps ports only when a 4X10GF module is present in slot 2. Refer to Creating stacking trunks on the ICX 7450 on page 115 for more information.
Linear-topology trunks	The ICX 7450-24P is the only model that supports linear trunks: stack-trunk 1/3/1 and 1/4/1 stack-trunk 1/2/1 to 1/2/4	Refer to Support for two-unit stack linear-topology trunks on page 36 for more information.
Hitless switchover and hitless failover	Supported	Refer to Hitless stacking on page 171.

TABLE 22 ICX 7450 stacking capability (continued)

Stacking capability	ICX 7450	Additional information
License requirements	No license required for stack-port configuration	Premium feature requires trust-based license. Refer to the <i>Ruckus FastIron Software Licensing Guide</i> for information.
Configuration options	Manual and automatic, including interactive-setup and zero-touch provisioning	Refer to Stack construction methods on page 56.
Access methods	TFTP, SCP	Software images, boot images, and signatures can be downloaded to a stack using TFTP and SCP. Refer to the <i>Ruckus FastIron Software Upgrade Guide</i> for more information.
Stacking commands	These commands are not available on the ICX 7450, except as noted: multi-stack-port , except when a 4X10GF module is present in slot 2 multi-stack-trunk , except when a 4X10GF module is present in slot 2 stack-trunk , except when a 4X10GF module is present in slot 2	

ICX 7450 stacking topologies

Up to 12 ICX 7450 units of any kind can be connected in a linear or ring topology. Valid-stack-ports are located on the rear panel as shown in the following figures. The valid-stack-port numbers are 1/3/1 and 1/4/1 (unit/slot/port); that is, they are the single port located in modules 3 and 4 of the ICX 7450 as shown.

The following figure shows the valid-stack-ports for the ICX 7450. These ports may also be used as data ports.

FIGURE 19 ICX 7450 1 X 40-Gbps valid-stack-ports

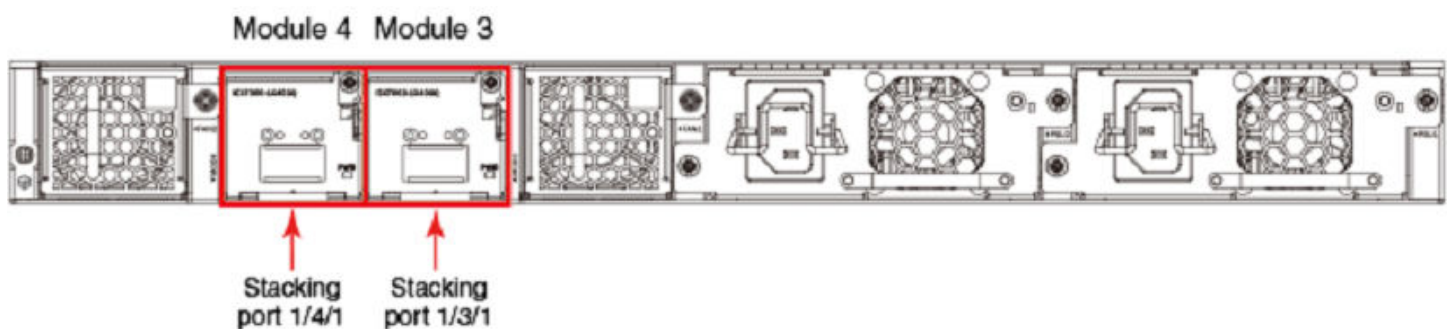

The following figure shows the 4X10GF module and port numbers.

NOTE

Changing stacking ports from 1/3/1 and 1/4/1 to any port on Module 2 (1/2/1 through 1/2/4) requires you to enter the **write memory** and the **reload** commands.

FIGURE 20 ICX 7450 module 2 ports available for stacking

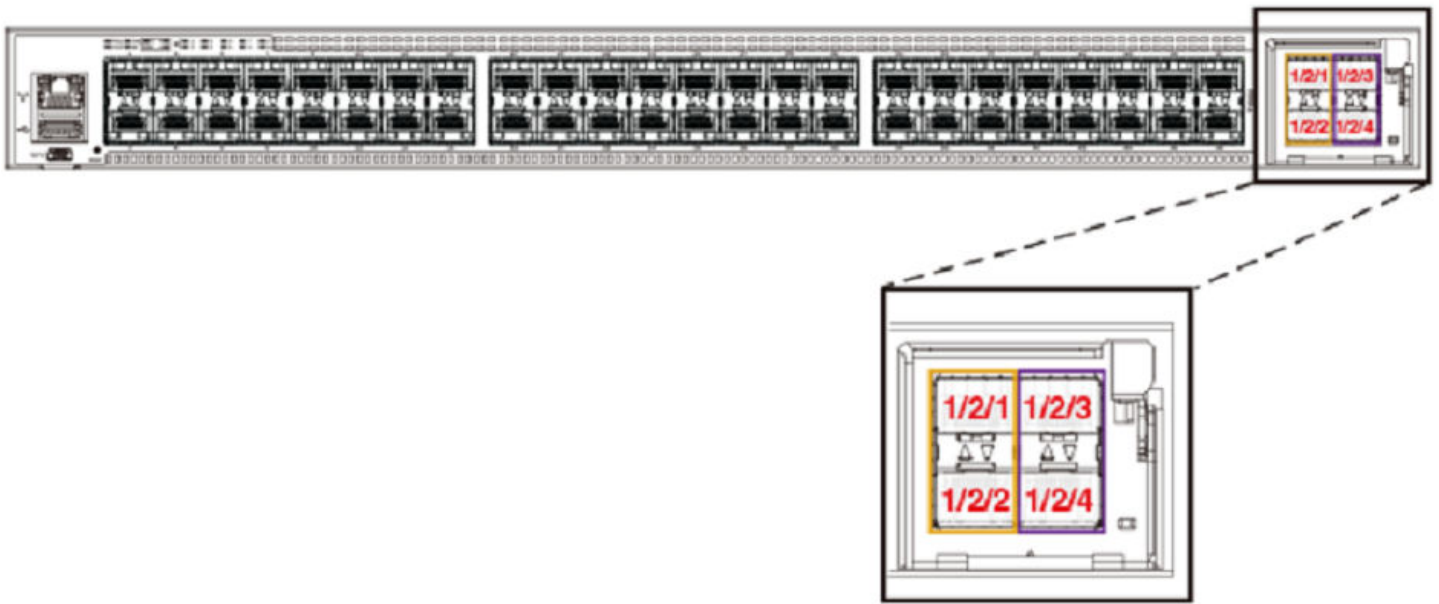

The following figure shows ICX 7450 units connected from 1 X 40-Gbps ports on the rear in a linear stack.

FIGURE 21 ICX 7450 1 X 40-Gbps linear stack

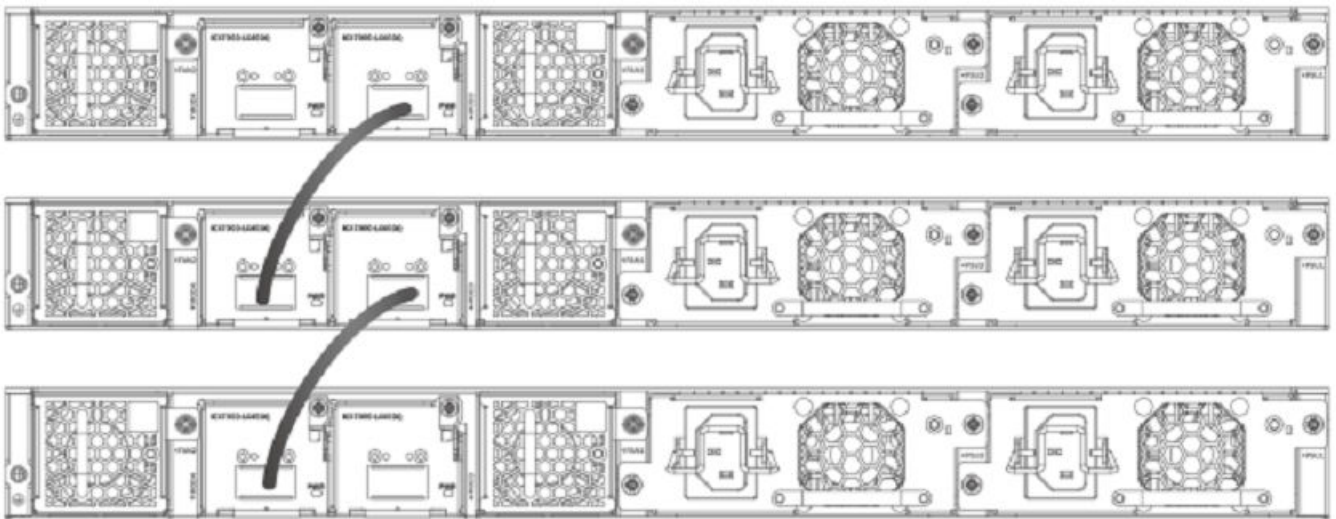

The following figure shows ICX 7450 units connected from 1 X 40-Gbps ports on the rear in a ring stack.

FIGURE 22 ICX 7450 1 X 40-Gbps ring stack

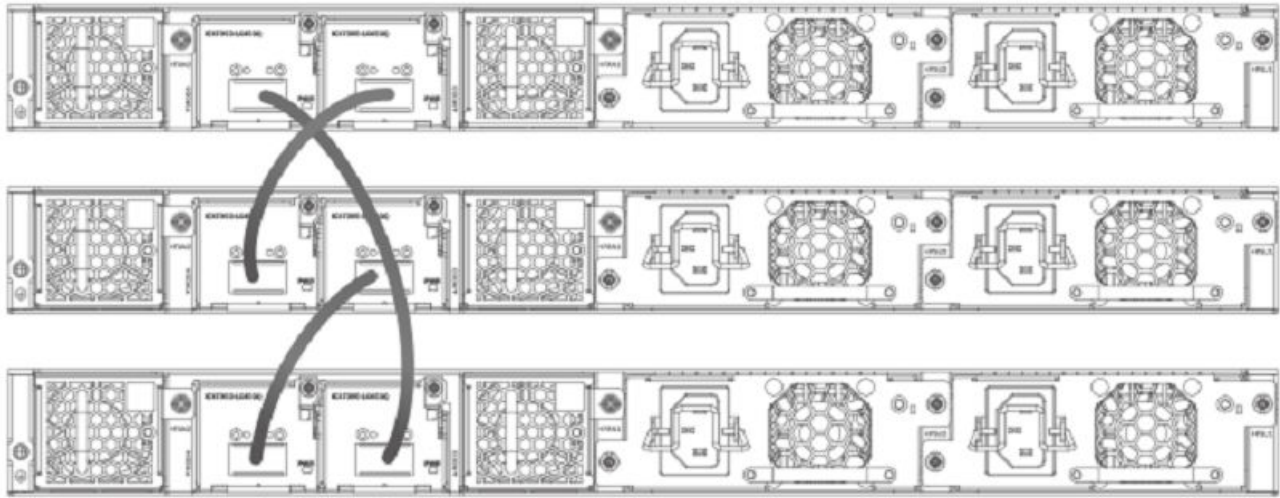

The following figure shows the ICX 7450 connected from the front in a ring using stacking trunks.

FIGURE 23 ICX 7450 4 X 10-Gbps ring using stacking trunks



The following figure shows the ICX 7450 connected from the front in a linear stack using stacking trunks.

FIGURE 24 ICX 7450 4 X 10-Gbps linear stack using stacking trunks



The following figures depict two-unit stacks with linear-topology trunks on the front and rear panel. ICX 7450-24P devices support this type of trunk, which improves redundancy and bandwidth. For more information, refer to [Support for two-unit stack linear-topology trunks](#) on page 36.

FIGURE 25 ICX 7450-24P two-unit stack with linear-topology trunk (front panel)

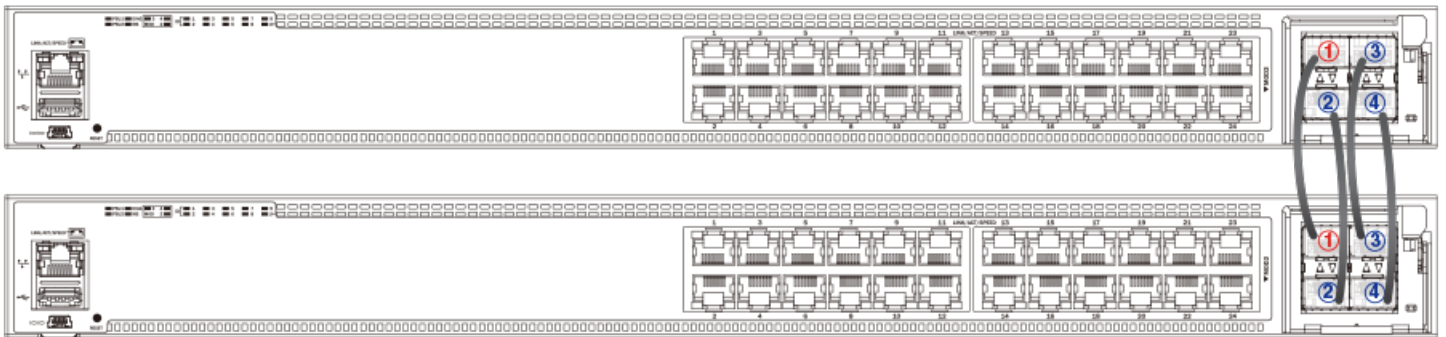
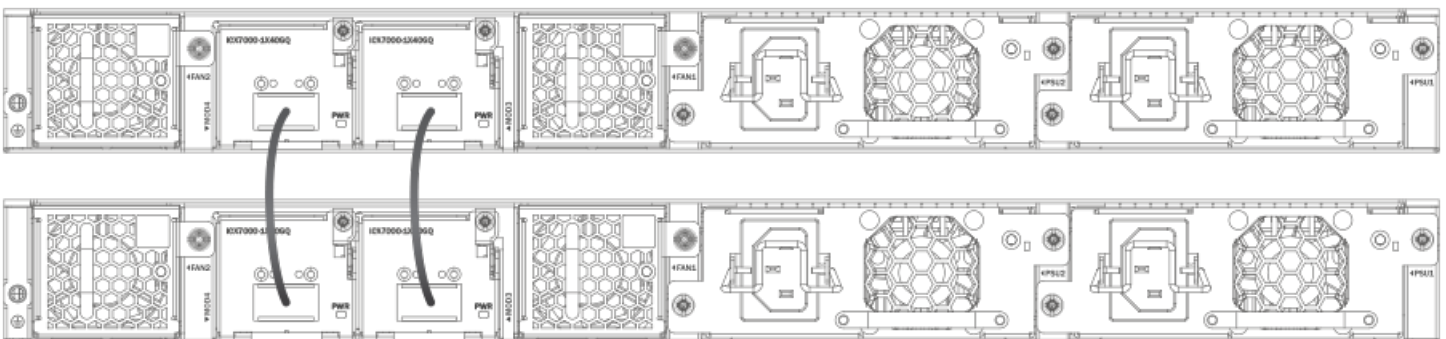

FIGURE 26 ICX 7450-24P two-unit stack with linear-topology trunk (rear panel)



ICX 7450 stacking configuration notes

- The 1 X 40-Gbps module supports stacking only when installed in rear panel slot 3 or 4.
- The ICX 7450 supports 10-Gbps stacking when a 4X10GF module is present in slot 2. Refer to [Configuring 10-Gbps stacking ports on ICX 7450 devices](#) on page 113 for more information on 4 X 10-Gbps ports.
- Stack ports can be configured using the **stack-port** or **stack-trunk** command.
- ICX 7450 units support stack trunks only on a 4 X 10-Gbps (4X10GF) module installed in slot 2.
- The 4X10GF ports can also support MACsec but not simultaneously. Refer to [Converting ICX 7450 slot 2 ports for MACsec or stacking](#) on page 114 for more information on converting 4 X 10-Gbps ports to or from MACsec.
- An IPsec module can be installed as an add-on in slot 2, 3, or 4 of an ICX 7450 device. Only one IPsec module should be installed in a stacking unit, and only one IPsec module is active in the stack at any time. A second IPsec module may be present in another stack unit; however, the second card does not provide active redundancy if the active IPsec module fails.
- When the stack interactive-setup utility is used to configure an ICX 7450 stack, endpoints or ports of ending units that are not used for stacking are left as data ports, except on active units, where both ports 1/3/1 and 1/4/1 (or both ports 1/2/1 and 1/2/3 with 4 X 10-Gbps stacking) become valid-stack-ports as a result of the **stack enable** command being executed.

Configuring 10-Gbps stacking ports on ICX 7450 devices

By default, the ICX 7450 uses 40-Gbps ports in slots 3 and 4 as stacking ports. When a 4X10GF module is installed in slot 2 on the front panel of an ICX 7450, 10-Gbps stacking can be configured.

NOTE

Stacking and MACsec cannot be configured on these 10-Gbps ports at the same time. Refer to [Converting ICX 7450 slot 2 ports for MACsec or stacking](#) on page 114 for more information.

To configure stacking on 10-Gbps ports in a 4X10GF module installed in slot 2, configure use the **stack-port** or **stack-trunk** command to configure stacking ports or trunks as shown in the following example.

```
ICX7450-48P Router# show stack
***** Warning! stack is not enabled. *****
T=1h27m15.0: alone: standalone, D: dynamic cfg, S: static
ID Type Role Mac Address Pri State Comment
1 S ICX7450-48P alone 609c.9f2a.97e0 0 local None:0
+----+
3/1| 1 |4/1
+----+
Current stack management MAC is 609c.9f2a.97e0
ICX7450-48P Router# configure terminal
ICX7450-48P Router(config)# stack unit 1
ICX7450-48P Router(config-unit-1)# stack-port 1/2/1
stack-port 1/2/1 replaces stack-port 1/3/1 and stack-port 1/4/1 <-- Previous stacking configuration
for other modules is replaced.
T=1h12m9.8: Module 2 was inited with MACSEC. Its ports cannot be stack-ports without a reload.
Reload required. Please write memory and then reload or power cycle.
ICX7450-48P Router(config-unit-1)#stack-port 1/2/3
T=1h12m16.2: Module 2 was inited with MACSEC. Its ports cannot be stack-ports without a reload.
Reload required. Please write memory and then reload or power cycle.
ICX7450-48P Router(config-unit-1)# show running-config
Current configuration:
!
ver 08.0.90
!
stack unit 1
module 1 icx7450-48p-poe-management-module
module 2 icx7400-xgf-4port-40g-module
```

Stacking by Device

ICX 7450 stack configuration overview

```
module 3 icx7400-qsfp-1port-40g-module
module 4 icx7400-qsfp-1port-40g-module
stack-port 1/2/1
stack-port 1/2/3
!
ICX7450-48P Router(config)# write memory |
! | <-- Required if stack-port or stack-trunk
ICX7450-48P Router(config)# end | configuration changes on prospective
ICX7450-48P Router# reload | active controller
!
```

Once the stack-ports are configured, enter the **write memory** and then the **reload** command, after which the unit is ready to join an existing stack or to be configured for stacking using stack interactive-setup or manual stack construction.

NOTE

You must enable stacking with the **stack enable** command before you can initiate stack interactive-setup or construct a stack.

NOTE

Changing the **stack-port** configuration and entering the **reload** command are not required for a unit to be discovered by stack interactive-setup or stack zero-touch provisioning. However, you must reload the prospective active controller after its stacking ports are changed before you initiate stack interactive-setup or stack zero-touch provisioning from that unit. The units to be discovered do not need to configure anything or reload. The active controller reloads them as members after they are discovered.

NOTE

If you use the manual construction method, you must reload every unit if you have changed stacking ports 1/3/1 and 1/4/1 to ports on slot 2.

Converting ICX 7450 slot 2 ports for MACsec or stacking

When a 4x10GF module is installed in slot 2 of the ICX 7450, it is enabled for MACsec even if the ports have not been configured. To use these ports for stacking, you must reconfigure them.

NOTE

The ICX 7450 can support 4 X 10-Gbps stacking from slot 2 or 40-Gbps stacking from rear ports; however, it cannot support both at the same time.

By default, if a 4X10GF module is present in slot 2, it is enabled for MACsec. No reload or power-cycle is required to enable or disable MACsec on slot 2 interfaces. However, to use the slot 2 ports for stacking, the stacking ports must be changed, and the unit must be reloaded as described in [Configuring 10-Gbps stacking ports on ICX 7450 devices](#) on page 113.

If the 4X10GF module in slot 2 is programmed for stacking during bootup, MACsec cannot be configured on the ports until the stacking ports have been changed to rear panel ports and the unit has been reloaded or turned off and on.

MACsec and stacking cannot be configured at the same time on slot 2 interfaces. However, 4X10GF modules installed in slots 3 and 4 on the rear panel of the ICX 7450 can support MACsec at the same time that slot 2 is configured for 4X10GF stacking.

The following error message is displayed when MACsec is configured on slot 2 and you try to set the stacking ports to slot 2.

```
Error - Please remove MACsec configuration from port <port_id> before using 4x10GF for stacking
```

If you try to use the **stack enable** command, the command is blocked, and the following message is displayed.

```
Error - Please remove MACsec configuration from port <port_id> before using 4x10GF for stacking
```

The following error message is displayed if stacking is configured on these ports and you enter the **enable-mka ethernet** command for any of the ports.

```
Error: MACsec is not allowed when 4x10GF module is used for stacking.
Please configure "stack-port" or "stack-trunk" to change stacking ports.
```

The following example reconfigures stacking ports on slot 2 for use as MACsec ports.

```
ICX7450-48P Router# show running-config
Current configuration:
!
ver 08.0.90
!
stack unit 1
module 1 icx7450-48p-poe-management-module
module 2 icx7400-xgf-4port-40g-module
module 3 icx7400-qsfp-1port-40g-module
module 4 icx7400-qsfp-1port-40g-module
stack-port 1/2/1
stack-port 1/2/3
!
ICX7450-48P Router# configure terminal
ICX7450-48P Router(config)# dot1x-mka
ICX7450-48P Router(config-dot1x-mka)# enable-mka ethernet 1/2/1
Error: MACsec is not allowed when 4x10GF module is used for stacking.
Please configure "stack-port" or "stack-trunk" to change stacking ports.
ICX7450-48P Router(config-dot1x-mka)# exit
ICX7450-48P Router(config)#stack unit 1
ICX7450-48P Router(config-unit-1)# stack-port 1/3/1
stack-port 1/3/1 replaces stack-port 1/2/1 and stack-port 1/2/3
ICX7450-48P Router(config-unit-1)# stack-port 1/4/1
ICX7450-48P Router(config-unit-1)# show running-config
Current configuration:
!
ver 08.0.90
!
stack unit 1
module 1 icx7450-48p-poe-management-module
module 2 icx7400-xgf-4port-40g-module
module 3 icx7400-qsfp-1port-40g-module
module 4 icx7400-qsfp-1port-40g-module
stack-port 1/3/1
stack-port 1/4/1
!
ICX7450-48P Router(config-unit-1)# dot1x-mka
ICX7450-48P Router(config-dot1x-mka)# enable-mka ethernet 1/2/1
Reload required. Please write memory and then reload or power cycle.
Error: This 4x10GF module has been used for stacking. To enable MACsec on it, a reload is required
ICX7450-48P Router(config-dot1x-mka)# write memory
Flash Memory Write (8192 bytes per dot)
.
Write startup-config done.
Copy Done.
ICX7450-48P Router(config-dot1x-mka)# exit
ICX7450-48P Router(config)# exit
ICX7450-48P Router# reload
Are you sure? (enter 'y' or 'n'):
```

Creating stacking trunks on the ICX 7450

The ICX 7450 supports two stacking trunks per stack unit when the 4X10GF module in slot 2 is used for stacking.

You can configure one or two stacking trunks on an ICX 7450 stand-alone as shown in the following example. Each stacking trunk can have two ports. Potential stacking trunks contain the stacking port and the next sequential port (1/2/1 through 1/2/2 and 1/2/3 through 1/2/4).

Stacking by Device

ICX 7450 stack configuration overview

NOTE

Valid-stack-ports 1/3/1 and 1/4/1, which are 40-Gbps ports on the rear panel of the ICX 7450, do not support stacking trunks.

NOTE

ICX 7450-24P devices support linear-topology trunks in a two-unit stack. In an ICX 7450-24P linear-topology trunk, you can configure ports 1/2/1 to 1/2/4 or ports 1/3/1 and 1/4/1 in one trunk. Refer to [Support for two-unit stack linear-topology trunks](#) on page 36 for more information.

The following example configures two stacking trunks.

```
ICX7450-48P Router# show running-config
Current configuration:
!
ver 08.0.90
!
stack unit 1
module 1 icx7450-48p-poe-management-module
module 2 icx7400-xgf-4port-40g-module
module 3 icx7400-qsfp-1port-40g-module
module 4 icx7400-qsfp-1port-40g-module
stack-port 1/3/1
stack-port 1/4/1
!
ICX7450-48P Router# configure terminal
ICX7450-48P Router(config)# stack unit 1
ICX7450-48P Router(config-unit-1)# stack-trunk 1/2/1 to 1/2/2
stack-trunk 1/2/1 to 1/2/2 replaces stack-port 1/3/1 and stack-port 1/4/1
T=2m11.3: Module 2 was initied with MACSEC. Its ports cannot be stack-ports without a reload.
Reload required. Please write memory and then reload or power cycle.
ICX7450-48P Router(config-unit-1)# stack-trunk 1/2/3 to 1/2/4
T=2m24.1: Module 2 was initied with MACSEC. Its ports cannot be stack-ports without a reload.
Reload required. Please write memory and then reload or power cycle.
ICX7450-48P Router(config-unit-1)# show running-config
Current configuration:
!
ver 08.0.90
!
stack unit 1
module 1 icx7450-48p-poe-management-module
module 2 icx7400-xgf-4port-40g-module
module 3 icx7400-qsfp-1port-40g-module
module 4 icx7400-qsfp-1port-40g-module
stack-trunk 1/2/1 to 1/2/2
stack-trunk 1/2/3 to 1/2/4
!
ICX7450-48P Router(config-unit-1)# exit
ICX7450-48P Router(config)# write memory
There is no startup config file, unable to save legacy config
Flash Memory Write (8192 bytes per dot)
.
Write startup-config done.
Copy Done.
ICX7450-48P Router(config)# exit
ICX7450-48P Router# reload
Are you sure? (enter 'y' or 'n'):
```

Creating stacking trunks on live stacks

Use the **multi-stack trunk** or **multi-stack port** command to add or remove a stacking trunk on a live ICX 7450 stack. The following example creates two stacking trunks.

```
device# configure terminal
device(config)# stack unit 1
device(config-unit-1)# multi-stack-trunk 1/2/1 to 1/2/2 and 2/2/1 to 2/2/2
device(config-unit-1)# end
device(config)# end
device#
```

NOTE

You can use the **multi-stack-port** command to create individual ports on a live stack. Available ports on slot 2 are 1/2/1 and 1/2/3.

ICX 7650 stack configuration overview

The following table provides an overview of ICX 7650 stacking capabilities.

TABLE 23 ICX 7650 stacking capabilities

Stacking capability	ICX 7650	Additional information
Topologies supported	Ring and linear	<p>NOTE ICX 7650 devices can operate in a stack only when the rear module (Module 3) is in Stacking Mode. Stacking is not available when the rear module is configured in Uplink Mode. Refer to ICX 7650 rear-module options on page 123 for more information.</p> <p>Refer to ICX 7650 stacking topologies on page 119 for sample linear and ring topologies.</p>
Maximum stack size	12	Stacking only. Any combination of ICX 7650 devices may be stacked.
Maximum stacking distance	10 Kilometers	Refer to FastIron stacking distances and optics by device on page 50 for more information.
Stacking ports	ICX 7650 devices support 40-Gbps and 100-Gbps stacking.	<p>Module 3 supports 4 X 40-Gbps stacking or 2 X 100-Gbps stacking (the default).</p> <p>Stacking port speeds can be changed to 40-Gbps with the rear-module stack-40G command. Refer to Changing ICX 7650 stacking speed on page 123 for instructions. Refer to ICX 7650 stacking ports on page 118 for module and port locations.</p>
Valid-stack-port sets	<p>For 100-Gbps stacking: (x/3/1, x/3/2, 1)</p> <p>For 40-Gbps stacking: (x/3/1, x/3/3, 2)</p> <p>NOTE The third number in the set is the maximum number of ports in a stacking trunk. One indicates stack-port only.</p>	<p>Refer to the definition of valid-stack-port set in Stacking terminology on page 19 and Valid-stack-port sets on page 23 for more information.</p> <p>Refer to ICX 7650 stacking ports on page 118 for module and port locations.</p>

TABLE 23 ICX 7650 stacking capabilities (continued)

Stacking capability	ICX 7650	Additional information
Reconfigurable ports	Supported	The rear-module command can be used to change stacking port speeds or to reconfigure stacking ports as uplink ports and vice versa. NOTE Valid-stack-port sets are specific to stacking port speed settings and cannot be reconfigured.
Stack trunks	Supported	2 X 40-Gbps bidirectional trunks are supported on ports 1/3/1 to 1/3/2 and ports 1/3/3 to 1/3/4. NOTE When stacking port speed changes, existing stacking trunk configuration may be removed. Refer to Configuring an ICX 7650 trunk manually on a non-production system on page 127 and Configuring an ICX 7650 stacking trunk on a live system on page 129.
Linear-topology trunks	For 100-Gbps: stack-trunk x/3/1 to x/3/2 For 40-Gbps: stack-trunk x/3/1 to x/3/4	Refer to Support for two-unit stack linear-topology trunks on page 36 for more information.
Hitless switchover and hitless failover	Supported	Refer to Hitless stacking on page 171.
License requirements	Premium Layer 3, MACsec	Static routing and RIP are the only Layer 3 protocols available without a license. All other Layer 3 protocols require a Premium Layer 3 license. A separate license is required for MACsec. Refer to the <i>Ruckus FastIron Software Licensing Guide</i> for more information.
Configuration options	Manual and automatic, including stack interactive-setup and zero-touch provisioning	Refer to Stack construction methods on page 56.
Access methods	TFTP, SCP	Software images, boot images, and signatures can be downloaded to a stack using TFTP and SCP. Refer to the <i>Ruckus FastIron Software Upgrade Guide</i> for more information.
Stacking commands	All stacking CLI is available on the ICX 7650 unless otherwise noted on the command reference page.	

ICX 7650 stacking ports

ICX 7650 devices support stacking through Module 3 on the rear panel, shown in the following figure.

FIGURE 27 ICX 7650 rear-module 40-Gbps stacking ports

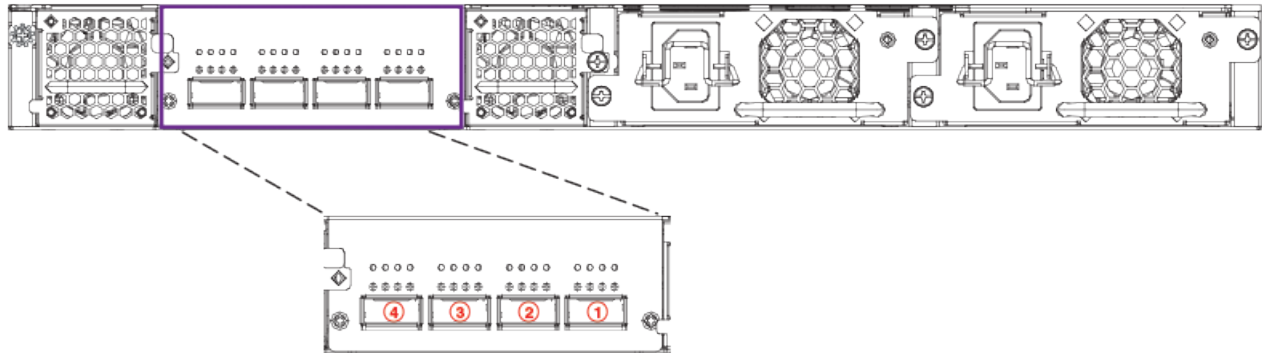

The rear module is fixed, and its ports can be configured for stacking or uplink. By default, the rear module supports 100-Gbps stacking on ports 1 and 2 (1/3/1 and 1/3/2). When 100-Gbps stacking is enabled, ports 3 and 4 are not used. Stacking trunks are not supported on 100-Gbps connections in a stack that contains more than two units. However, a 100-Gbps linear-topology trunk (ports 1/3/1 to 1/3/2) is supported in a two-unit stack.

The rear-module stacking configuration can be changed to support four 40-Gbps stacking ports using the rear-module uplink-40g command. Stacking ports or stacking trunks can be configured on 40-Gbps connections.

NOTE

Rear-module ports can also be configured as data uplink ports. Refer to [ICX 7650 rear-module options](#) on page 123 for more information.

ICX 7650 stacking topologies

All ICX 7650 models support stacking from Module 3 on the rear panel. ICX 7650 stacks containing any combination of ICX 7650 models can be connected in linear or ring configurations.

ICX 7650 100-Gbps linear stack

The following figure depicts a three-unit stack of ICX 7650 devices configured in a 100-Gbps linear stack.

FIGURE 28 ICX 7650 100-Gbps linear stack

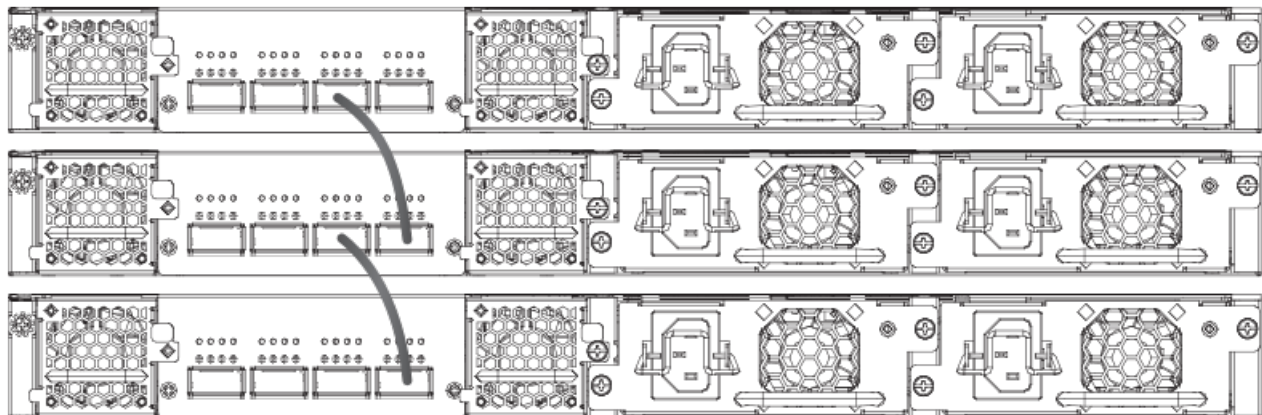

ICX 7650 100-Gbps ring stack

The following figure depicts a three-unit stack of ICX 7650 devices configured in a 100-Gbps ring stack.

FIGURE 29 ICX 7650 100-Gbps ring stack

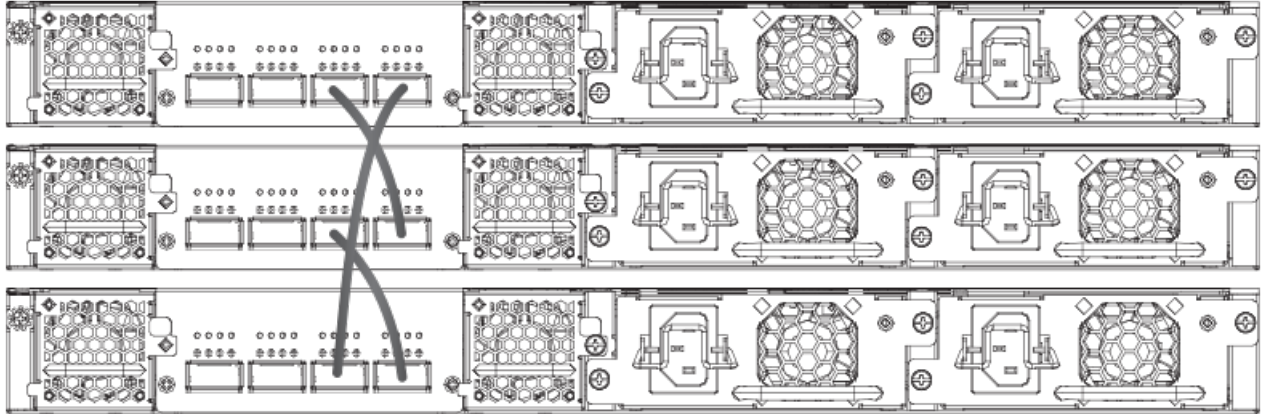

ICX 7650 40-Gbps linear stack

The following figure depicts a three-unit stack of ICX 7650 devices configured in a 40-Gbps linear stack.

FIGURE 30 ICX 7650 40-Gbps linear stack

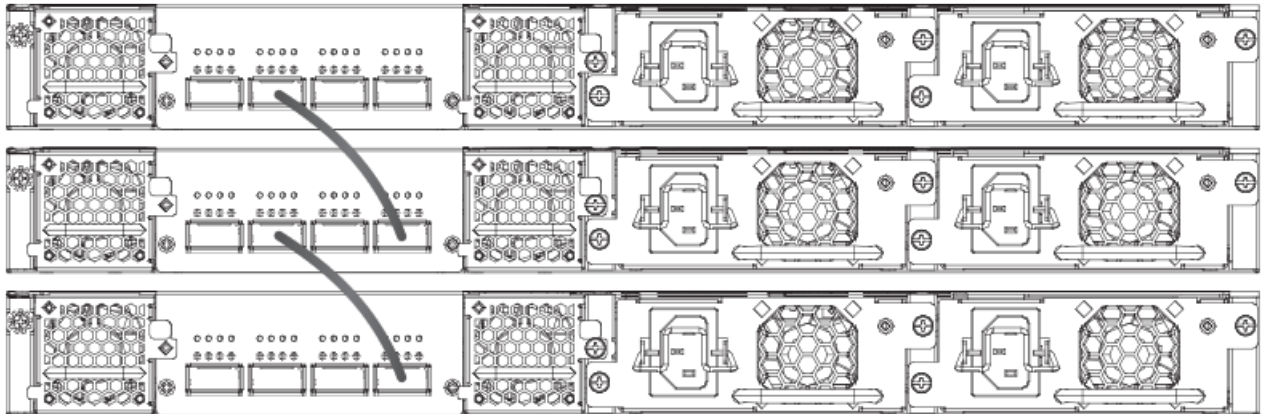

ICX 7650 40-Gbps ring stack

The following figure depicts a three-unit stack of ICX 7650 devices configured in a 40-Gbps ring stack.

FIGURE 31 ICX 7650 40-Gbps ring stack

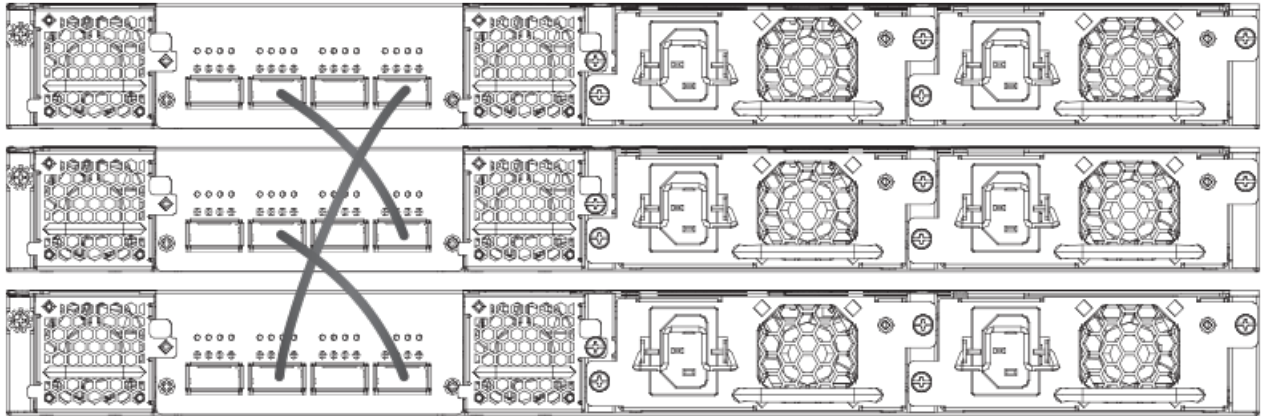

ICX 7650 40-Gbps trunk

The following figure depicts a three-unit stack of ICX 7650 devices configured in a 40-Gbps stack with a trunk.

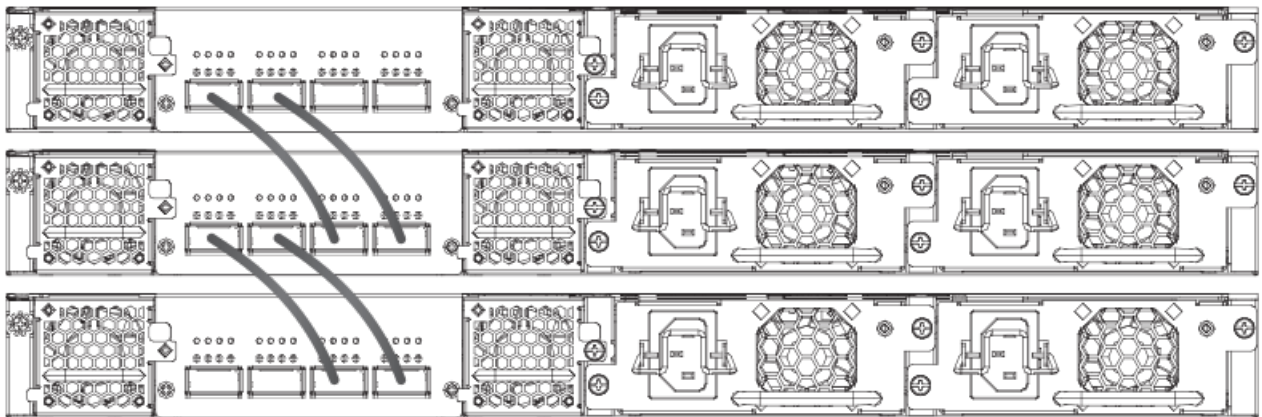

ICX 7650 two-unit stack with linear-topology trunk

The following figures depict a two-unit stack linear-topology trunk for a 40-Gbps connection and for a 100-Gbps connection. All ICX 7650 models support this type of trunk, which improves redundancy and bandwidth. For more information, refer to [Support for two-unit stack linear-topology trunks](#) on page 36.

FIGURE 32 ICX 7650-48ZP two-unit stack linear-topology trunk (40 Gbps)

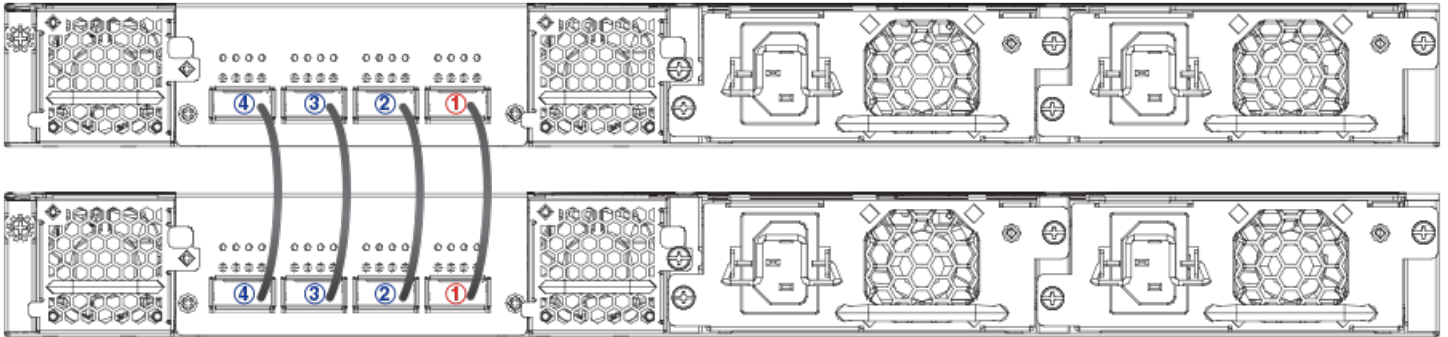
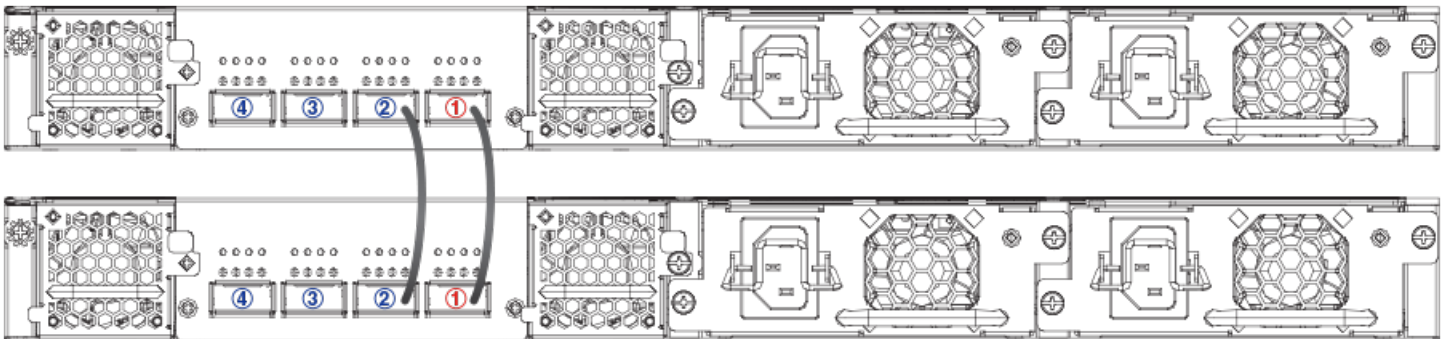

FIGURE 33 ICX 7650-48ZP two-unit stack linear-topology trunk (100 Gbps)



ICX 7650 configuration notes

Consider these items when configuring an ICX 7650 stack:

- On ICX 7650 devices, "rear module" refers to Module 3.
- Stacking ports operate in 100-Gbps stacking mode by default when an ICX 7650 device has no rear-module configuration.
- Optics and stacking ports differ for 100-Gbps and 40-Gbps stacking. Connections remain down if you attempt to configure stacking with a port speed mismatch. It is the user's responsibility to change the optics.
- To join a stack, a new ICX 7650 unit must be preconfigured to match the **rear-module** configuration of the existing stack.
- You cannot issue a **rear-module stack-40g** or **no rear-module** command unless the data uplink configuration has been removed from the ports.
- When a stack has been formed, you cannot configure the rear module for uplink mode without removing the stacking configuration from all stack members and rebooting the units.
- Stack units must be configured with matching High-Gig Ethernet settings.
- When the rear module is operating in uplink mode, you can configure stacking offline; however, stacking elections are blocked. When you execute the **write memory** command, you will be prompted to save or erase the stacking configuration. If you elect to erase the stacking configuration with the **erase startup-config** command, all the stacking configuration, including the stacking.boot file configuration, is removed.
- Stacking or uplink mode settings must be saved with the **write memory** command and do not become active until the **reload** command is issued for the stack or standalone unit.

- If uplink mode is active on the ICX 7650 rear module, Module 2 cannot be used for uplink.
- If the ICX 7650 rear module has been operating in stacking mode, is reconfigured for uplink mode, and later is returned to stacking mode, Module 2 uplink port configuration may be lost. When Module 3 has been configured with the command **rear-module uplink-100g** or **rear-module uplink-40g** and before the user executes the **write memory** command to save the configuration, the following warning message appears: "After reload, rear module ports will be configured as uplink ports, and module 2 will be unused. Existing configurations for ports in module 2 may be removed."
- A configuration mismatch with the physical module installed as Module 2 can cause a stacking unit to become non-operational. The mismatch can be resolved by removing the unit from the stack so that the active controller relearns its configuration or by correcting module information. Refer to [Resolving Module 2 mismatches in an ICX 7650 stack](#) on page 135 for more information. For additional information on Module 2, refer to the *ICX 7650 Switch Hardware Installation Guide*.

ICX 7650 rear-module options

NOTE

ICX 7650 devices cannot operate in a stack when the rear module is configured for data uplink. Stacking election mechanisms and all stacking operations, including IPC communications, are blocked in uplink mode.

The following operating modes can be configured on the ICX 7650 fixed rear module (Module 3):

- 2 X 100-Gbps stacking (the default)
- 4 X 40-Gbps stacking
- 2 X 100-Gbps data uplink
- 2 X 40-Gbps data uplink

Changing ICX 7650 stacking speed

Be sure to connect stacking ports using optics that are compatible with the planned port speed. Be sure that the correct ports are connected. Be sure that speeds match on both ends of the stacking connection.

1. To change the rear-module stacking speed from 100 Gbps to 40 Gbps, enter the following commands on each affected unit.

```
device# configure terminal
device(config)# rear-module stack-40g
device(config)# write memory
device(config)# exit
device# reload
```

The example sets ICX 7650 speeds on ports x/3/1 through x/3/4 to 40 Gbps and configures valid-stack-ports x/3/1 and x/3/3. The change takes effect when the **reload** command is used.

- To remove the 40-Gbps stacking configuration and return the rear-module stacking speed to the default of 100 Gbps, enter the following commands on each affected unit.

```
device# configure terminal
device(config)# no rear-module stack-40g
device(config)# write memory
device(config)# exit
device# reload
```

The example configures ICX 7650 valid-stack-ports x/3/1 and x/3/2 for 100 Gbps. (Ports 3 and 4 are not used.) The change takes effect when the **reload** command is used.

NOTE

If 40-Gbps stacking trunks are configured, the configuration is removed.

NOTE

Different stacking ports are used for the two speeds. Be sure cables are connected correctly and correct optics are used before changing the stacking speed.

Converting stacking ports to data uplink ports

Be sure port connections are correct before changing modes or speeds. Be sure local and remote ports operate in the same mode and at the same speed.

NOTE

ICX 7650 devices cannot operate in a stack when the rear module is configured for data uplink. Stacking election mechanisms and all stacking operations, including IPC communications, are blocked in uplink mode.

When the rear module operates in stacking mode and has active member units attached to it, you cannot convert the rear module to uplink mode. To change the rear module to uplink mode, you must first unconfigure the stack.

Follow these steps to convert the rear module (Module 3) of an ICX 7650 device from stacking to uplink mode.

- (Optional) Enter the **show stack** command to check for active stack configuration.

```
ICX7650-48F Router# show stack
T=7m25.5: alone: standalone, D: dynamic cfg, S: static
ID Type Role Mac Address Pri State Comment
1 S ICX7650-48F active 94fd.2e05.1a10 0 local Ready
2 D ICX7650-48P member 00e0.5200.0100 0 remote Ready
active
+---+ +---+
3/3| 2 |3/1--3/1| 1 |3/3
+---+ +---+
There is no standby. Will assign a standby in 39 sec
Current stack management MAC is 94fd.2e05.1a10
```

- On the active controller for the stack, enter the **stack unconfigure all** command, and enter **y** when prompted to remove the stacking configuration from all stack members.

```
ICX7650-48F Router# stack unconfigure all
Will dismantle the entire stack and recover pre-stacking startup config. Are you sure? (enter 'y' or 'n'):
y Removed "stack enable" from startup-config
All units recover startup-config. Reset others
"stack enable" is removed from runtime config of this unit.
ICX7650-48F Router# Remove stack enable. This unit will not actively participate in stacking.
```

The example removes the stacking configuration from all stack members.

3. In global configuration mode on each unit, enter the **rear-module uplink** command with the desired uplink speed.

NOTE

You must enter the **write memory** command and then reload for the configuration takes effect. This removes module two from operation as well as ports 1/3/1 and 1/3/4. The following system warning is issued.

```
ICX7650-48F Router(config)# rear-module uplink-100g
ICX-7650 rear module setting changes requires a reload to take effect!!!
The rear module would operate in uplink mode with 100Gbps speed after reload.
After reload, rear module ports will be configured as uplink ports, and module 2 will be
unused.
Existing configurations for ports in module 2 may be removed.
```

4. Enter the **write memory** command to save the configuration.
5. Enter the **reload** command in privileged EXEC mode to apply the new configuration.

Any configuration is removed from module 2, and it is not in use after the reload. Ports 1/3/1 and 1/3/4 are also unused after the reload.

The following example unconfigures the stack and configures one ICX 7650 rear module for data uplink at 100 Gbps on ports 1/3/1 and 1/3/2. (Ports 1/3/3 and 1/3/4 are not used.)

```
ICX7650-48F Router# stack unconfigure all
Will dismantle the entire stack and recover pre-stacking startup config. Are you sure? (enter 'y' or 'n'):
y Removed "stack enable" from startup-config
All units recover startup-config. Reset others
"stack enable" is removed from runtime config of this unit.
ICX7650-48F Router# Remove stack enable. This unit will not actively participate in stacking.
ICX7650-48F Router(config)# rear-module uplink-100g
ICX-7650 rear module setting changes requires a reload to take effect!!!
The rear module would operate in uplink mode with 100Gbps speed after reload.
ICX7650-48F Router(config)# write memory
Flash Memory Write (8192 bytes per dot)
.
Write startup-config done.
Copy Done.
ICX7650-48F Router(config)# exit
ICX7650-48F Router# reload
```

The following example unconfigures the stack and configures one ICX 7650 rear module for data uplink at 40 Gbps on ports 1/3/1 through 1/3/4.

```
ICX7650-48F Router# stack unconfigure all
Will dismantle the entire stack and recover pre-stacking startup config. Are you sure? (enter 'y' or 'n'):
y Removed "stack enable" from startup-config
All units recover startup-config. Reset others
"stack enable" is removed from runtime config of this unit.
ICX7650-48F Router# Remove stack enable. This unit will not actively participate in stacking.
ICX7650-48F Router(config)# rear-module uplink-40g
ICX-7650 rear module setting changes requires a reload to take effect!!!
The rear module would operate in uplink mode with 40Gbps speed after reload.
ICX7650-48F Router(config)# write memory
Flash Memory Write (8192 bytes per dot)
.
Write startup-config done.
Copy Done.
ICX7650-48F Router(config)# exit
ICX7650-48F Router# reload
```

Converting data uplink ports to stacking ports

Be sure port connections are correct before changing modes or speeds. Be sure local and remote ports operate in the same mode and at the same speed.

NOTE

ICX 7650 devices cannot operate in a stack when the rear module is configured for data uplink. Stacking election mechanisms and all stacking operations, including IPC communications, are blocked in uplink mode.

Follow these steps to convert the rear module (Module 3) of an ICX 7650 device from uplink to stacking mode.

1. Enter global configuration mode.

```
ICX7650-48P Router# configure terminal
```

2. Enter the **no rear-module** command to restore the rear-module default (100-Gbps stacking mode).

```
ICX7650-48P Router(config)# no rear-module
```

3. Enter the **write memory** command to save the change.

```
ICX7650-48P Router(config)# write memory
```

4. Reload the unit to put the mode change into effect.

```
ICX7650-48P Router(config)# exit
ICX7650-48P Router# reload
```

The following example removes the data uplink configuration from an ICX 7650 device, restores the default (100-Gbps stacking), saves the configuration, and reloads the unit so that it operates in 100-Gbps stacking mode.

NOTE

For information on changing the stacking speed, refer to [Changing ICX 7650 stacking speed](#) on page 123.

```
ICX7650-48P Router(config)# no rear-module
ICX7650-48F Router(config)# write memory
Flash Memory Write (8192 bytes per dot)
.
Write startup-config done.
Copy Done.
ICX7650-48F Router(config)# exit
ICX7650-48F Router# reload

ICX7650-48F Router# show rear-module
The rear module operates in stacking mode with 100G speed.
The rear module is configured in stacking mode with 100G speed.
ICX7650-48F Router#
```

Forming an ICX 7650 stack

Be sure the rear module on all ICX 7650 units is cabled correctly before configuring stacking.

You can use the **stack interactive-setup** command as outlined in this procedure to configure an ICX 7650 stack. Other options for configuring a stack are also available. For more information on stack construction, refer to [Stack construction methods](#) on page 56.

1. (Optional) Use the **show rear-module** command to verify that the rear module is operating in a stacking mode. The default mode is 100-Gbps stacking.

```
ICX7650-48P Router# show rear-module
The rear module operates in stacking mode with 100G speed.
The rear module is configured in stacking mode with 100G speed.
```

The example shows the unit is operating in default mode (100-Gbps stacking).

2. If necessary, reconfigure the rear module for each unit in the stack to operate in the desired stacking mode. This may require removing the data uplink configuration. Refer to [ICX 7650 rear-module options](#) on page 123 for more information.
3. Enable stacking on each unit you plan to include in the stack.

```
ICX7650-48P Router# configure terminal
ICX7650-48P Router(config)# stack enable
Enable stacking. This unit actively participates in stacking
```

4. Enter the **stack interactive-setup** command to configure the stack automatically. Respond to system prompts to confirm the stack configuration and to specify options such as the number of units in the stack, preferred unit IDs, the formation of multiple links as stacking trunks, and the creation of a ring topology.

```
ICX7650-48P Router(config)# exit
ICX7650-48P Router# stack interactive-setup
!
```

Configuring an ICX 7650 trunk manually on a non-production system

Stacking trunks can be configured on ICX 7650 devices operating in 40-Gbps stacking mode.

The stack interactive-setup process includes the option to form trunks when multiple links are possible. You may also opt to configure a trunk manually.

Follow these steps to create a trunk manually on an ICX 7650 stack that is not live.

NOTE

Stacking trunks can be configured only when the rear module is operating in 40-Gbps stacking mode. Refer to [ICX 7650 rear-module options](#) on page 123 for more information.

NOTE

Trunk configuration may be removed when you change stacking speeds.

1. (Optional) Verify that stacking is enabled and that the rear module is configured in 40-Gbps stacking mode.

```

ICX7650-48P Router# show running-config
Current configuration:
!
ver 08.0.90
!
stack unit 1
  module 1 icx7650-48p-port-management-module
  module 2 icx7600-qsfp-2port-80g-module
  module 3 icx7650-qsfp-4port-160g-module
  priority 128
  stack-port 1/3/1
  stack-port 1/3/3
stack mac 609c.9f52.5eb9
!
!

rear-module stack-40g
!
!

hitless-failover enable
!
!

end

ICX7650-48P Router# show stack

**** Warning! stack is not enabled. ****

T=21h4m4.2: alone: standalone, D: dynamic cfg, S: static
ID  Type      Role   Mac Address  Pri State  Comment
1  S ICX7650-48P  alone   609c.9f52.5eb9 128 local  None:0

      +----+
      3/1| 1 |3/3
      +----+

```

The example shows that the unit is operating in 40-Gbps stacking mode, but stacking is not enabled. No stacking links are configured to other units.

2. Enter stack unit configuration mode to configure trunks.

```

ICX7650-48P Router# configure terminal
ICX7650-48P Router(config)# stack unit 1
ICX7650-48P Router(config-unit-1)#
ICX7650-48P Router(config-unit-1)# stack-trunk 1/3/1 to 1/3/2
ICX7650-48P Router(config-unit-1)# stack-trunk 1/3/3 to 1/3/4
ICX7650-48P Router(config-unit-1)# exit

```

The example configures two stacking trunks on stack unit 1.

3. If necessary, enable stacking on the device.

```

ICX7650-48P Router# configure terminal
ICX7650-48P Router(config)# stack enable
Enable stacking. This unit actively participates in stacking

```

4. Enter the **write memory** command to save the trunk configuration.

```

ICX7650-48P Router(config-unit-1)# end
ICX7650-48P Router# write memory

```

- Repeat the previous steps to enable stacking and configure trunks as needed on all units in the stack.

NOTE

This step is configured on each separate unit. As shown in the example, each standalone unit identifies itself as "stack unit 1" until it joins a stack.

```
ICX7650-48P Router# configure terminal
ICX7650-48P Router(config)# stack unit 1
ICX7650-48P Router(config-unit-1)# stack-trunk 1/3/1 to 1/3/2
ICX7650-48P Router(config-unit-1)# exit
ICX7650-48P Router(config)# stack enable
```

The example shows a standalone unit being enabled for stacking and configured with a single stacking trunk.

- Wait for the election to take place.

The second unit is reloaded as a stack member.

- (Optional) Confirm that the stack has formed based on the stacking links configured.

```
ICX7650-48P Router# show stack
T=21h9m2.2: alone: standalone, D: dynamic cfg, S: static
ID  Type          Role  Mac Address  Pri State  Comment
1  S  ICX7650-48P    active  609c.9f52.5eb9 128 local  Ready
2  D  ICX7650-48P    member  609c.9f52.74c3 128 remote Ready

          active
+----+   +----+
3/3| 2 |3/1==3/1| 1 |3/3
+----+   +----+
There is no standby. Will assign a standby in 4 sec

Current stack management MAC is 609c.9f52.5eb9
Stack ports are operating at 40G.

ICX7650-48P Router#T=21h9m7.3: Assigned unit 2 to be standby
T=21h9m9.3: start running config sync to standby u2
T=21h9m9.8: Running config sync to standby u2 is complete
```

The example shows a two-unit stack has formed with a single stacking trunk connection.

Configuring an ICX 7650 stacking trunk on a live system

Follow these steps to convert stacking ports on both ends of a link to a stacking trunk on an ICX 7650 production stack.

- (Optional) Enter the **show stack** command to verify stack configuration.

```
ICX7650-48ZP Router# show stack
T=20h23m43.6: alone: standalone, D: dynamic cfg, S: static
ID  Type          Role  Mac Address  Pri State  Comment
1  S  ICX7650-48ZP  active  609c.9f52.2cd5 128 local  Ready
2  S  ICX7650-48F  standby 609c.9f52.4643 128 remote Ready

          active          standby
+----+   +----+
-3/3| 1 |3/1--3/1| 2 |3/3-
| +----+   +----+ |
|-----|
Standby u2 - protocols ready, can failover or manually switch over
Role history: N: standalone, A: active, S: standby, M: member
U1: M->S->A, U2: A->S

Current stack management MAC is 609c.9f52.2cd5
Stack ports are operating at 40G.
```

The example shows a two-unit live stack configured in a ring with no trunks.

Stacking by Device

ICX 7650 stack configuration overview

- (Optional) Enter the **show running-config** command for additional information on the stack.

```
ICX7650-48ZP Router# show running-config | inc stack
stack unit 1
  stack-port 1/3/1
  stack-port 1/3/3
stack unit 2
  stack-port 2/3/1
  stack-port 2/3/3
stack enable
stack rconsole-off
stack mac 609c.9f52.2cd5
rear-module stack-40g
```

The example includes only stacking information in the **show running-config** command output. The output confirms that the ICX 7650 stack is operating in 40-Gbps stacking mode.

- Enter stack unit configuration mode.

```
ICX7650-48ZP Router# configure terminal
ICX7650-48ZP Router(config)#stack unit 1
ICX7650-48ZP Router(config-unit-1)#
```

- Enter the **multi-stack-trunk** command followed by the set of ports on either end of the live connection to include in the stacking trunk.

```
ICX7650-48ZP Router(config-unit-1)# multi-stack-trunk 1/3/1 to 1/3/2 and 2/3/1 to 2/3/2
SYSLOG: <14> Sep  7 19:13:52 System: Interface ethernet 1/3/2, state down

SYSLOG: <14> Sep  7 19:13:52 System: Interface ethernet 2/3/2, state down
T=20h25m17.5: Election, was active, no change, ID=1, pri=128, 2U(1-2), A=u1, nbr#=1 1, reason: u1:
stk-po-chg, ,

SYSLOG: <14> Sep  7 19:13:52 Stack: Stack unit 1 has been elected as ACTIVE unit of the stack system

SYSLOG: <14> Sep  7 19:13:53 System: Interface ethernet 1/3/2, state up

SYSLOG: <14> Sep  7 19:13:53 System: Interface ethernet 2/3/2, state up

ICX7650-48ZP Router(config-unit-1)# end
```

The example configures a stacking trunk from ports 1/3/1 to 1/3/2 on one end of the connection to ports 2/3/1 and 2/3/2 on the other end.

- Enter the **write memory** command in privileged Exec mode to save the configuration.

```
ICX7650-48ZP Router(config-unit-1)# end

SYSLOG: <14> Sep  7 19:13:57 Security: running-config was potentially changed by operator from
console

ICX7650-48ZP Router# write memory

Automatic copy to member units:  2
ICX7650-48ZP Router#
SYSLOG: <14> Sep  7 19:13:59 Security: startup-config was changed by operator from console
Flash Memory Write (8192 bytes per dot)
.
Write startup-config done.
Copy Done.
```

The example saves the 40-Gbps trunk configuration.

- (Optional) Enter the **show stack** command to confirm the formation of the trunk.

```

ICX7650-48ZP Router# show stack
T=20h24m41.8: alone: standalone, D: dynamic cfg, S: static
ID   Type           Role   Mac Address     Pri State   Comment
1   S ICX7650-48ZP  active 609c.9f52.2cd5 128 local   Ready
2   S ICX7650-48F   standby 609c.9f52.4643 128 remote Ready

      active           standby
      +---+           +---+
-3/3| 1 |3/1==3/1| 2 |3/3-
|   +---+           +---+   |
|   |               |       |
|-----|
Will assign standby in 47 sec due to all ready

Standby u2 - protocols ready, can failover
Role history: N: standalone, A: active, S: standby, M: member
U1: M->S->A, U2: A->S

Current stack management MAC is 609c.9f52.2cd5
Stack ports are operating at 40G.
  
```

The example shows a trunk is present.

Removing an ICX 7650 trunk on a live system

Follow these steps to remove a stacking trunk and convert connections to individual links at both ends of the connection on an ICX 7650 production stack.

- (Optional) Enter the **show stack** command to verify the stack configuration.

```

ICX7650-48ZP Router# show stack
T=20h18m50.1: alone: standalone, D: dynamic cfg, S: static
ID   Type           Role   Mac Address     Pri State   Comment
1   S ICX7650-48ZP  active 609c.9f52.2cd5 128 local   Ready
2   S ICX7650-48F   standby 609c.9f52.4643 128 remote Ready

      active           standby
      +---+           +---+
=3/3| 1 |3/1==3/1| 2 |3/3=
|   +---+           +---+   |
|   |               |       |
|-----|
Will assign standby in 54 sec due to startup synced

Standby u2 - protocols ready, can failover
Role history: N: standalone, A: active, S: standby, M: member
U1: M->S->A, U2: A->S

Current stack management MAC is 609c.9f52.2cd5
Stack ports are operating at 40G.
  
```

The example shows a two-unit stack in a ring configuration with two trunks configured between the two units.

Stacking by Device

ICX 7650 stack configuration overview

- (Optional) Enter the **show running-config** command for additional information on the stack.

```
ICX7650-48ZP Router# show running-config | inc stack
stack unit 1
  stack-trunk 1/3/1 to 1/3/2
  stack-trunk 1/3/3 to 1/3/4
stack unit 2
  stack-trunk 2/3/1 to 2/3/2
  stack-trunk 2/3/3 to 2/3/4
stack enable
stack rconsole-off
stack mac 609c.9f52.2cd5
rear-module stack-40g
ICX7650-48ZP Router# show stack
T=20h19m18.0: alone: standalone, D: dynamic cfg, S: static
ID  Type      Role   Mac Address  Pri State  Comment
1   S ICX7650-48ZP active  609c.9f52.2cd5 128 local  Ready
2   S ICX7650-48F  standby 609c.9f52.4643 128 remote Ready

      active      standby
      +---+      +---+
=3/3| 1 |3/1==3/1| 2 |3/3=
|  +---+      +---+  |
|  |-----|  |
|-----|

Will assign standby in 26 sec due to startup synced

Standby u2 - protocols ready, can failover
Role history: N: standalone, A: active, S: standby, M: member
U1: M->S->A, U2: A->S

Current stack management MAC is 609c.9f52.2cd5
Stack ports are operating at 40G.
```

The example shows specific port-to-port connections for the stacking trunks and confirms that the stack is operating in 40-Gbps stacking mode.

- Enter stack unit configuration mode.

```
ICX7650-48ZP Router# configure terminal
ICX7650-48ZP Router(config)# stack unit 1
ICX7650-48ZP Router(config-unit-1)#
```

4. Enter the **multi-stack-port** command followed by the set of ports on either end of the live trunk to convert to stacking ports.

```
ICX7650-48ZP Router(config-unit-1)# multi-stack-port 1/3/1 and 2/3/1
ICX7650-48ZP Router(config-unit-1)# end

ICX7650-48ZP Router(config-unit-1)#T=20h20m35.3: Election, was active, no change, ID=1, pri=128,
2U(1-2), A=u1, nbr#=1 1, reason: ul: stk-po-chg, ,

SYSLOG: <14> Sep 7 19:09:10 Stack: Stack unit 1 has been elected as ACTIVE unit of the stack syste
SYSLOG: <14> Sep 7 19:09:12 System: Interface ethernet 1/3/2, state down
SYSLOG: <14> Sep 7 19:09:12 System: Interface ethernet 2/3/2, state down

ICX7650-48ZP Router#
SYSLOG: <14> Sep 7 19:09:12 Security: running-config was potentially changed by operator from
console

ICX7650-48ZP Router#
ICX7650-48ZP Router#
SYSLOG: <14> Sep 7 19:09:12 System: Interface ethernet 2/3/2, state up

SYSLOG: <14> Sep 7 19:09:13 System: Interface ethernet 1/3/2, state up

ICX7650-48ZP Router#
```

The example removes a stacking trunk and converts these ports to stacking ports on both ends of the link: ports 1/3/1, 1/3/2, 2/3/1, and 2/3/2.

5. Repeat the previous steps if you are removing two live trunks.

```
ICX7650-48ZP Router# configure terminal
ICX7650-48ZP Router(config)# stack unit 1
ICX7650-48ZP Router(config-unit-1)# multi-stack-port 1/3/3 and 2/3/3

ICX7650-48ZP Router(config-unit-1)#end

T=20h21m28.8: Election, was active, no change, ID=1, pri=128, 2U(1-2),
A=u1, nbr#=1 1, reason: ul: stk-po-chg, ,

SYSLOG: <14> Sep 7 19:10:04 Stack: Stack unit 1 has been elected as ACTIVE unit of the stack system
d
ICX7650-48ZP Router#
SYSLOG: <14> Sep 7 19:10:04 Security: running-config was potentially changed by operator from
console

ICX7650-48ZP Router#
```

The example removes the stacking trunk configuration at both ends of the remaining trunk and converts these ports to stacking ports: 1/3/3, 1/3/4, 2/3/3, and 2/3/4.

6. Enter the **write memory** command in privileged EXEC mode to save the configuration.

```

ICX7650-48ZP Router# write memory
Automatic copy to member units: 2

SYSLOG: <14> Sep 7 19:10:05 System: Interface ethernet 1/3/4, state down
SYSLOG: <14> Sep 7 19:10:05 System: Interface ethernet 2/3/4, state down

SYSLOG: <14> Sep 7 19:10:06 Security: startup-config was changed by operator from console
Flash Memory Write (8192 bytes per dot)
.
Write startup-config done.
Copy Done.
ICX7650-48ZP Router#
SYSLOG: <14> Sep 7 19:10:06 System: Interface ethernet 2/3/4, state up

ICX7650-48ZP Router#
SYSLOG: <14> Sep 7 19:10:06 System: Interface ethernet 1/3/4, state up
sh stack
T=20h20m45.4: alone: standalone, D: dynamic cfg, S: static
ID  Type          Role      Mac Address    Pri State  Comment
1   S ICX7650-48ZP  active   609c.9f52.2cd5 128 local  Ready
2   S ICX7650-48F   standby  609c.9f52.4643 128 remote Ready

      active          standby
      +----+          +----+
-3/3| 1 |3/1--3/1| 2 |3/3-
|   +----+          +----+ |
|   |   |   |   |   |
|-----|
Will assign standby in 55 sec due to all ready

Standby u2 - protocols ready, can failover
Role history: N: standalone, A: active, S: standby, M: member
U1: M->S->A, U2: A->S

Current stack management MAC is 609c.9f52.2cd5
Stack ports are operating at 40G.

```

The example saves the 40-Gbps stacking configuration with no trunks present.

7. (Optional) Enter the **show stack** command to confirm the configuration.

```

ICX7650-48ZP Router# show stack

T=20h20m45.4: alone: standalone, D: dynamic cfg, S: static
ID  Type          Role      Mac Address    Pri State  Comment
1   S ICX7650-48ZP  active   609c.9f52.2cd5 128 local  Ready
2   S ICX7650-48F   standby  609c.9f52.4643 128 remote Ready

      active          standby
      +----+          +----+
-3/3| 1 |3/1--3/1| 2 |3/3-
|   +----+          +----+ |
|   |   |   |   |   |
|-----|
Will assign standby in 55 sec due to all ready

Standby u2 - protocols ready, can failover
Role history: N: standalone, A: active, S: standby, M: member
U1: M->S->A, U2: A->S

Current stack management MAC is 609c.9f52.2cd5
Stack ports are operating at 40G.

```

The example confirms that the two-unit stack is operating in a ring with individual stacking links and no stacking trunks.

Resolving Module 2 mismatches in an ICX 7650 stack

When an ICX 7650 stack unit rejoins a stack with a different module type installed as Module 2, a configuration mismatch occurs, and the active controller places the stack unit in non-operational mode.

Follow these steps to correct a module configuration mismatch in an ICX 7650 stack.

1. Enter the **show stack** command to confirm that a unit has become non-operational due to a configuration mismatch.

```
ICX7650-48P Router# show stack
T=1d4h22m36.1: alone: standalone, D: dynamic cfg, S: static
ID Type           Role      Mac Address      Pri State  Comment
1 S ICX7650-48P    active   609c.9f52.6353  128 local Ready
2 S ICX7650-48P    standby  609c.9f52.5a9b   0 remote Ready
3 S ICX7650-48ZP  member   609c.9f52.32e3   0 remote NON-OP: config mismatch <-- Unit 3 non-
operational
4 S ICX7650-48ZP  member   609c.9f52.2743   0 remote Ready
active                                     standby                                     due to mismatch
+---+ +---+ +---+ +---+
-3/1| 1 |3/2--3/2| 4 |3/1--3/1| 3 |3/2--3/2| 2 |3/1-
| +---+ +---+ +---+ +---+ |
|-----|
Standby u2 - protocols ready, can failover
Current stack management MAC is 609c.9f52.6353
Stack ports are operating at 100G.
```

The example shows a configuration mismatch on stack unit 3.

NOTE

You can use the **show module** command to diagnose the mismatch.

2. Use one of the following options to resolve an identified configuration mismatch:
 - Option 1: In global configuration mode, enter the **no stack unit** command followed by the stack number of the offending device to remove the unit from the stack and allow it to rejoin.

```
ICX7650-48P Router# configure terminal
ICX7650-48P Router(config)# no stack unit 3
ICX7650-48P Router(config)#T=1d4h28m30.3: Election, was active, no change, ID=1, pri=128,
4U(1-4),
A=u1, nbr#=3 3, reason: u2: unit-removal, ,
Detect stack member 3 POE capable
All entries are cleared on unit 1 for unit 3
T:1d4h27m36.1: Done hot swap: active controller u1 sets u3 to Ready.
```

The example removes stack unit 3 from the stack and shows the unit rejoining the stack with the correct configuration.

- Option 2: In stack unit configuration mode for the non-operational unit, enter the **no module 2** command to remove the incorrect module configuration, which allows the correct module information to be learned.

```
ICX7650-48P Router# configure terminal
ICX7650-48P Router(config)# stack unit 3
ICX7650-48P Router(config-unit-3)# no module 2
```

3. (Optional) Enter the **show module** command to verify that the new configuration for Module 2 has been learned.

```
ICX7650-48P Router(config-unit-3)# show module
Module
U1:M1 ICX7650-48P POE 48-port Management Module OK 48 609c.9f52.6353
U1:M2 ICX7600-2X40GQ 2-port 80G Module OK 2 609c.9f52.6384
U1:M3 ICX7650-2X100G 2-port 200G Module OK 2 609c.9f52.6388
U2:M1 ICX7650-48P POE 48-port Management Module OK 48 609c.9f52.5a9b
U2:M2 ICX7600-2X40GQ 2-port 80G Module OK 2 609c.9f52.5acc
U2:M3 ICX7650-2X100G 2-port 200G Module OK 2 609c.9f52.5ad0
U3:M1 ICX7650-48ZP POE 48-port Management Module OK 48 609c.9f52.32e3
U3:M2 ICX7600-2X40GQ 2-port 80G Module OK 2 609c.9f52.3314
U3:M3 ICX7650-2X100G 2-port 200G Module OK 2 609c.9f52.3318
U4:M1 ICX7650-48ZP POE 48-port Management Module OK 48 609c.9f52.2743
U4:M2 ICX7600-2X40GQ 2-port 80G Module OK 2 609c.9f52.2774
U4:M3 ICX7650-2X100G 2-port 200G Module OK 2 609c.9f52.2778
```

The example displays the updated configuration of Module 2 in stack unit 3 as a 2-port 80-Gbps module.

4. (Optional) Enter the **show stack** command to confirm that the stack unit has returned to operation.

```
ICX7650-48P Router(config-unit-3)# show stack
T=1d4h54m37.4: alone: standalone, D: dynamic cfg, S: static
ID Type Role Mac Address Pri State Comment
1 S ICX7650-48P active 609c.9f52.6353 128 local Ready
2 S ICX7650-48P standby 609c.9f52.5a9b 0 remote Ready
3 S ICX7650-48ZP member 609c.9f52.32e3 0 remote Ready
4 S ICX7650-48ZP member 609c.9f52.2743 0 remote Ready
active standby
+---+ +---+ +---+ +---+
-3/1| 1 |3/2--3/2| 4 |3/1--3/1| 3 |3/2--3/2| 2 |3/1-
| +---+ +---+ +---+ +---+ |
|-----|
Will assign standby in 49 sec due to all ready
Standby u2 - protocols ready, can failover
Current stack management MAC is 609c.9f52.6353
Stack ports are operating at 100G.
```

ICX 7750 stack configuration overview

The following table provides an overview of ICX 7750 stacking capabilities.

TABLE 24 ICX 7750 stacking capability

Stacking capability	ICX 7750	Additional information
Topologies supported	Ring and linear	Refer to ICX 7750 stacking topologies on page 138.
Maximum stack size	12	Stacking only.
Maximum stacking distance	10 kilometers	Refer to FastIron stacking distances and optics by device on page 50 and Installing the ICX 7750 in a remote stack on page 143 for more information.
ICX 7750 model combinations	Allowed	ICX 7750-48C, ICX 7750-48F, and ICX 7750-26Q models can be combined in the same stack.

TABLE 24 ICX 7750 stacking capability (continued)

Stacking capability	ICX 7750	Additional information
Stacking ports	12 total ports available simultaneously: Six 40-Gbps ports, Module 2: 1/2/1 to 1/2/6 (Front) and Six 40-Gbps ports, Module 3: 1/3/1 to 1/3/6 (Rear)	Refer to "Valid-stack-port sets" in this table for information on using Module 2 (right front) and Module 3 (rear) simultaneously for stacking.
Valid-stack-port sets	There are 6 valid-stack-port sets: (x/2/1, x/2/4, 3) (x/3/1, x/3/4, 3) (x/2/1, x/3/1, 6) (x/2/5, x/2/6, 1) (x/3/5, x/3/6, 1) (x/2/5, x/3/5, 2) NOTE The third number in the set is the maximum number of ports in a stacking trunk. One indicates a single stack-port only.	Refer to the definition of valid-stack-port set in Stacking terminology on page 19 and Valid-stack-port sets on page 23 for more information. Refer to ICX 7750 stacking topologies on page 138 for port locations.
Reconfigurable ports	Use the <code>and stack-port</code> and <code>stack-trunk</code> commands to reconfigure ports.	
Trunks	Up to two stack trunks	NOTE Refer to Creating an ICX 7750 stacking link in a production environment on page 147. NOTE To set up long-distance stacking trunks on 48-port units, refer to Installing the ICX 7750 in a remote stack on page 143. Refer to "Valid-stack-port sets" in this table for common trunk configurations.
Linear-topology trunks	The following maximum linear-topology trunks are supported: 1/2/1 to 1/2/6 and 1/3/1 to 1/3/6 or 1/2/5 to 1/2/6 and 1/3/5 to 1/3/6	Refer to Support for two-unit stack linear-topology trunks on page 36 for more information.
Hitless switchover and hitless failover	Supported	Refer to Hitless stacking on page 171.
License requirements	No license required for stack-port configuration. No license required for Premium features.	For more information on ICX 7750 license options, refer to the <i>Ruckus FastIron Software Licensing Guide</i> .
Configuration options	Manual and automatic, including stack interactive-setup and zero-touch provisioning	Refer to Stack construction methods on page 56.
Access methods	TFTP, SCP	Software images, boot images, and signatures can be downloaded to a stack using TFTP and SCP applications. Refer to the <i>Ruckus FastIron Software Upgrade Guide</i> for more information.

TABLE 24 ICX 7750 stacking capability (continued)

Stacking capability	ICX 7750	Additional information
Stacking commands	All stacking CLI is supported.	

ICX 7750 stacking topologies

The following figures show available ICX 7750 stacking ports on the front and rear panel. Available front panel stacking ports are 1/2/1 through 1/2/6. Valid-stack-ports are 1/2/1 and 1/2/4.

FIGURE 34 ICX 7750 stacking ports on front panel

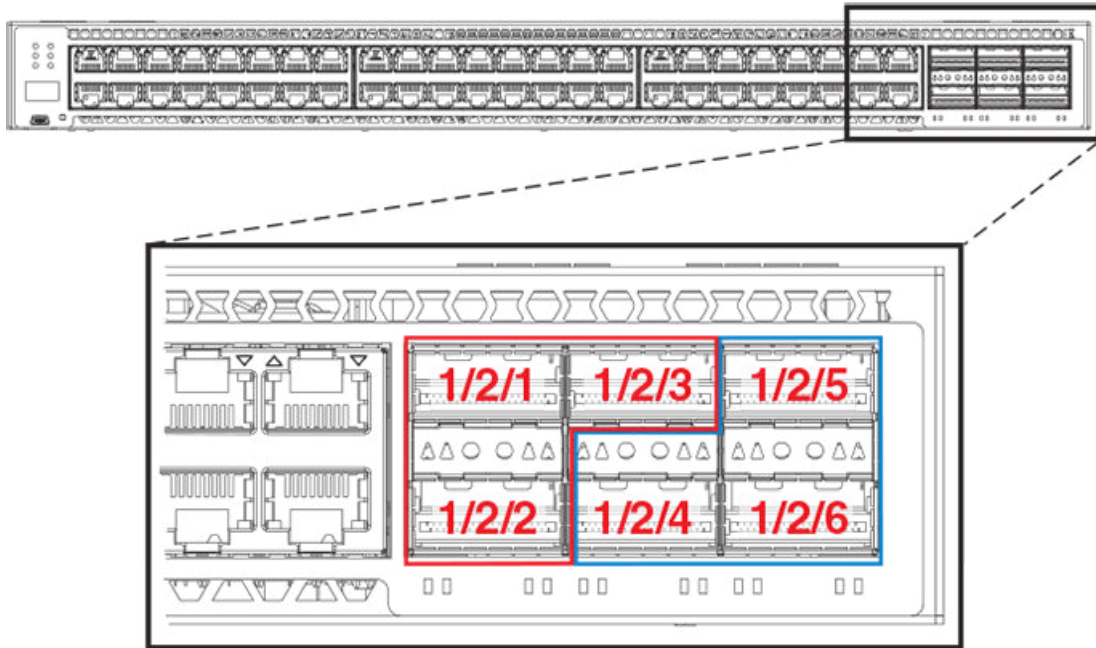
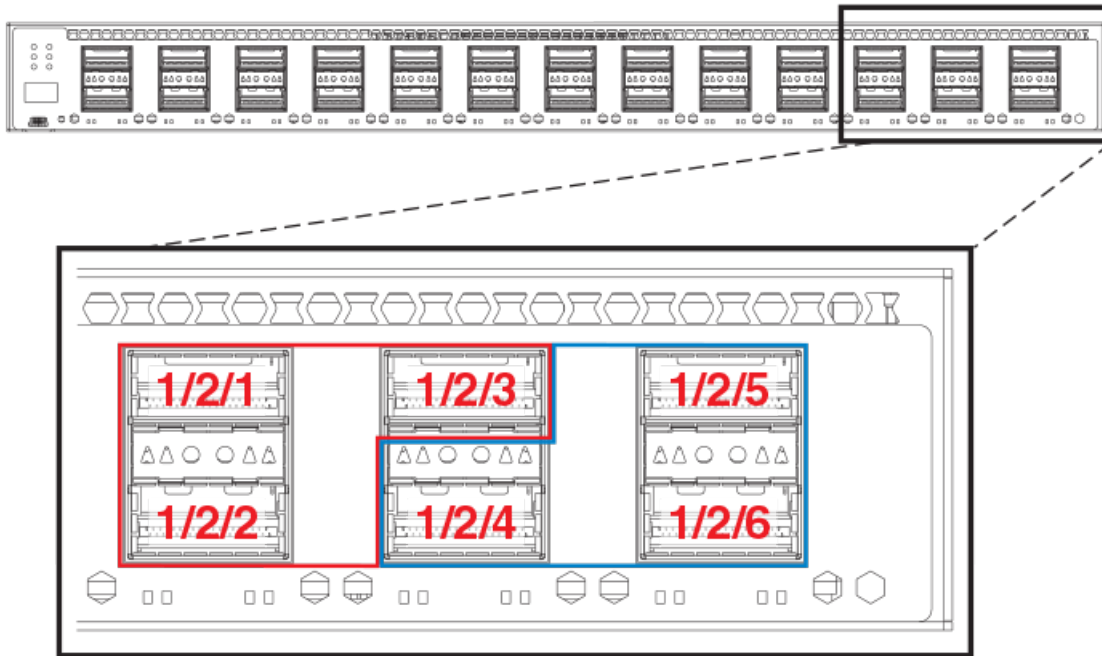
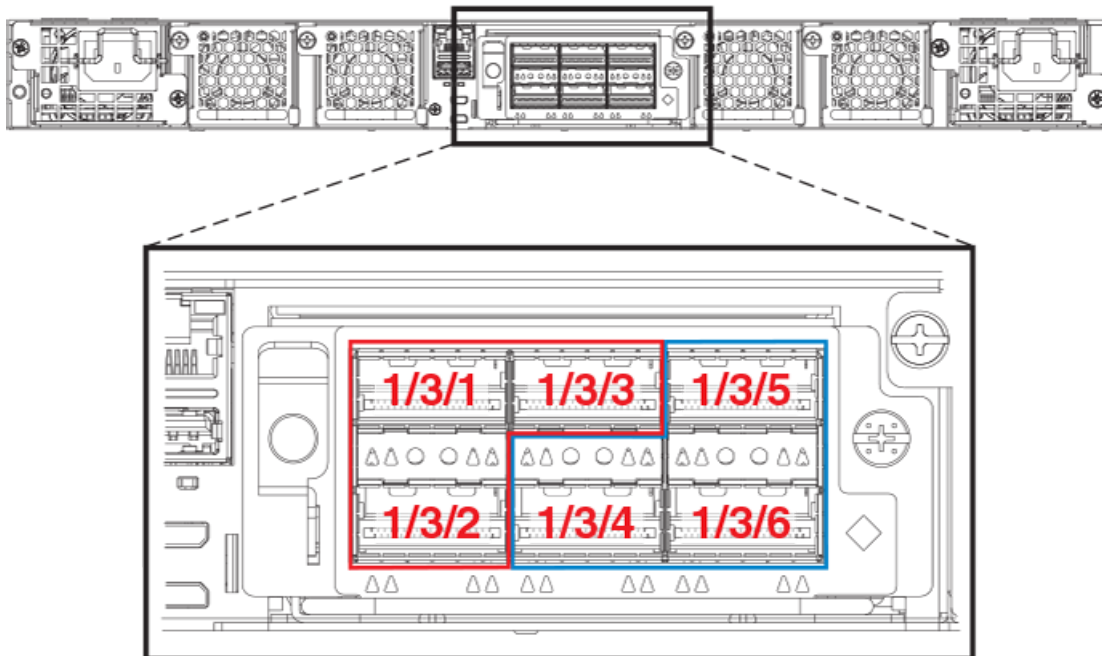

FIGURE 35 ICX 7750-26Q front panel stacking ports



Available stacking ports on the ICX 7750 rear panel are ports 1/3/1 through 1/3/6.

FIGURE 36 ICX 7750 stacking ports on rear panel



The following figure shows an ICX 7750 linear stack.

FIGURE 37 ICX 7750 linear stack from rear panel

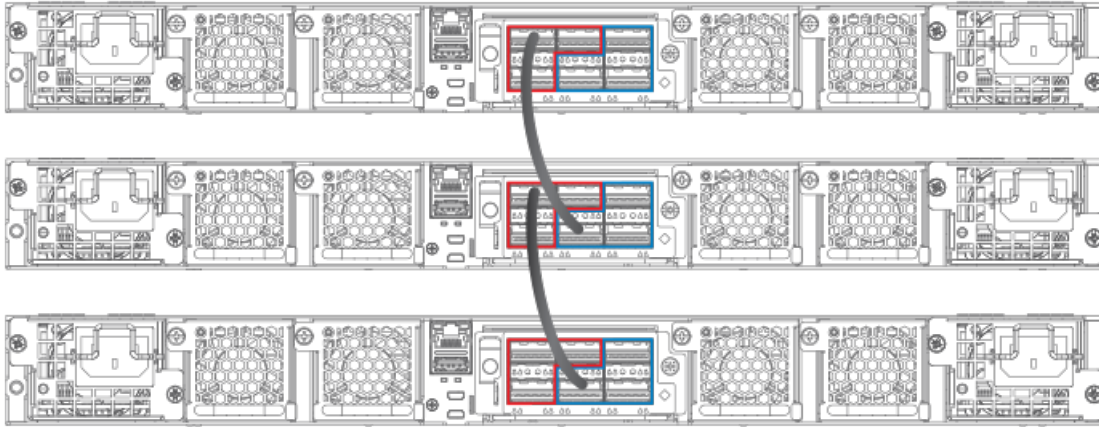

The following figures show ICX 7750 ring stacks from the front and rear panels. Default valid-stack-ports are located on the front panel, but they can be changed to the rear panel using the **stack-port** or **stack-trunk** command.

FIGURE 38 ICX 7750 ring stack from front panel

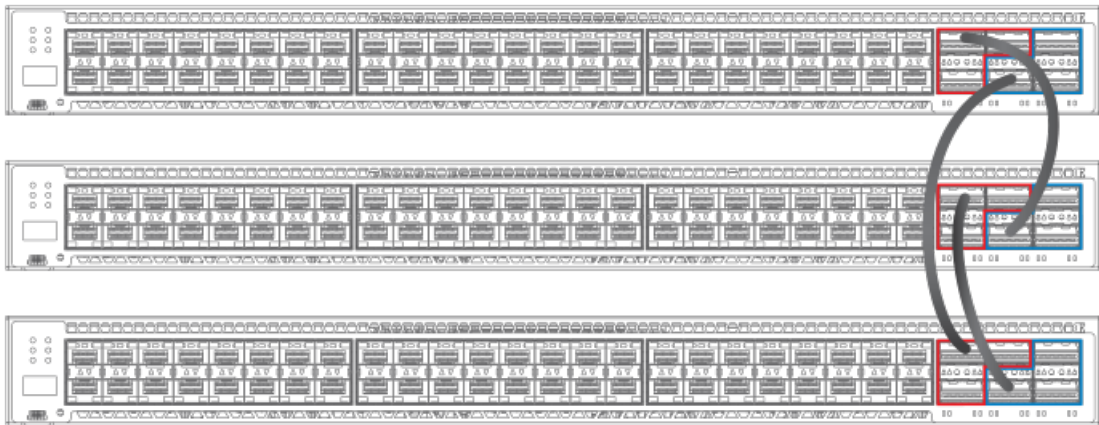

FIGURE 39 ICX 7750 ring stack from rear panel

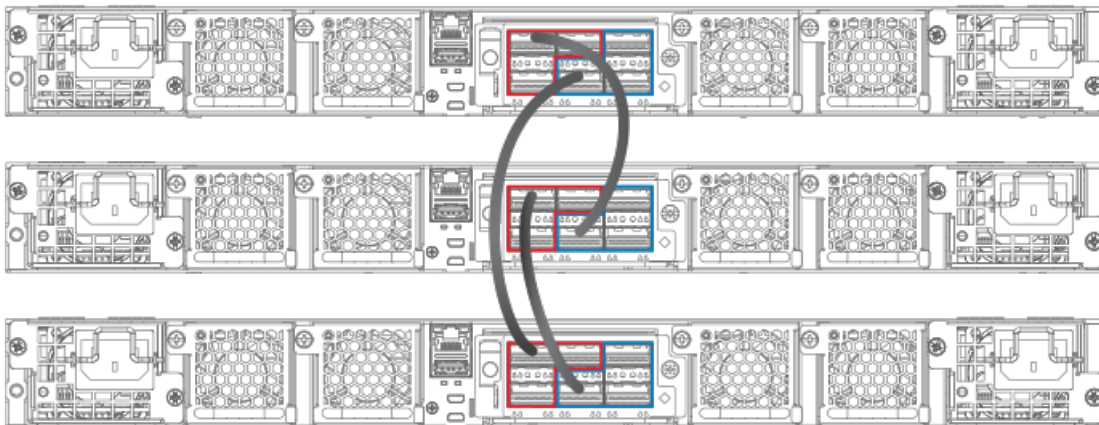
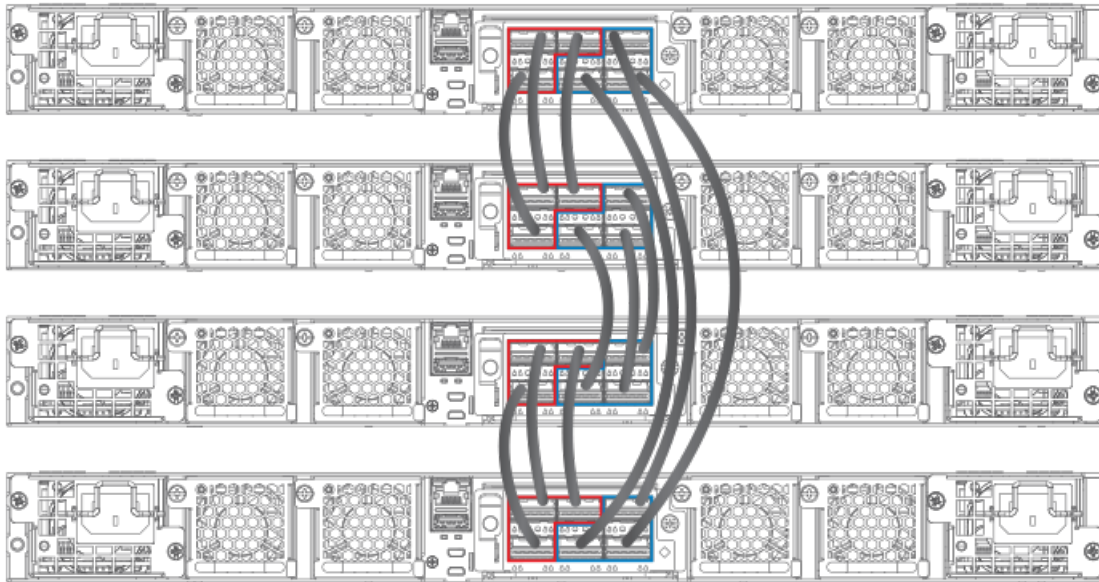

FIGURE 40 ICX 7750 fully populated ring stack from rear panel with three-port stacking trunks



ICX 7750 two-unit stacks with linear-topology trunks

The following figures depict ICX 7750 two-unit stacks with linear-topology trunks, for a four-port trunk configuration and a twelve-port trunk configuration. All ICX 7750 models (ICX 7750-48C shown, ICX 7750-48F, and ICX 7750-32Q) support this type of trunk, which improves redundancy and bandwidth. For more information, refer to [Support for two-unit stack linear-topology trunks](#) on page 36.

FIGURE 41 ICX 7750-48C two-unit stack with linear-topology trunk (four-port trunk)

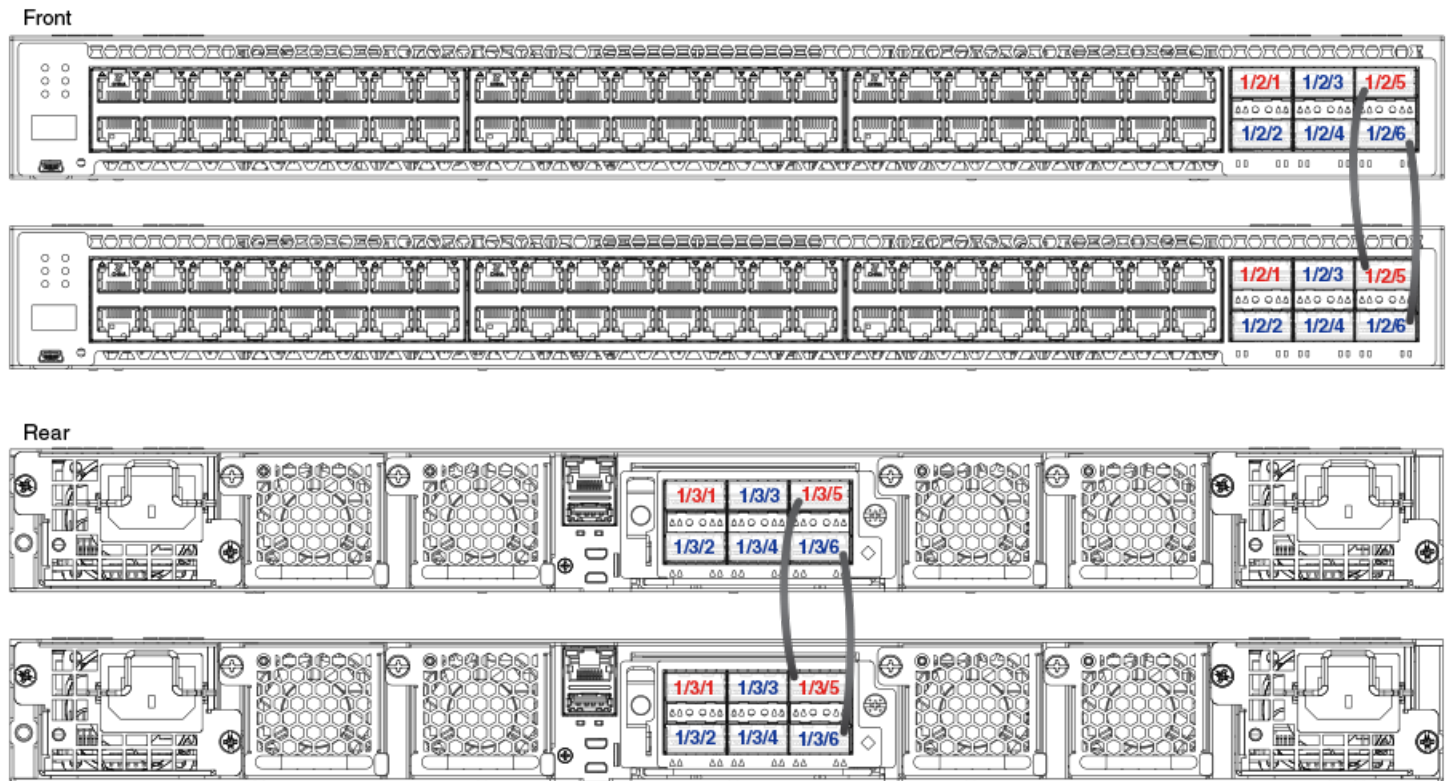
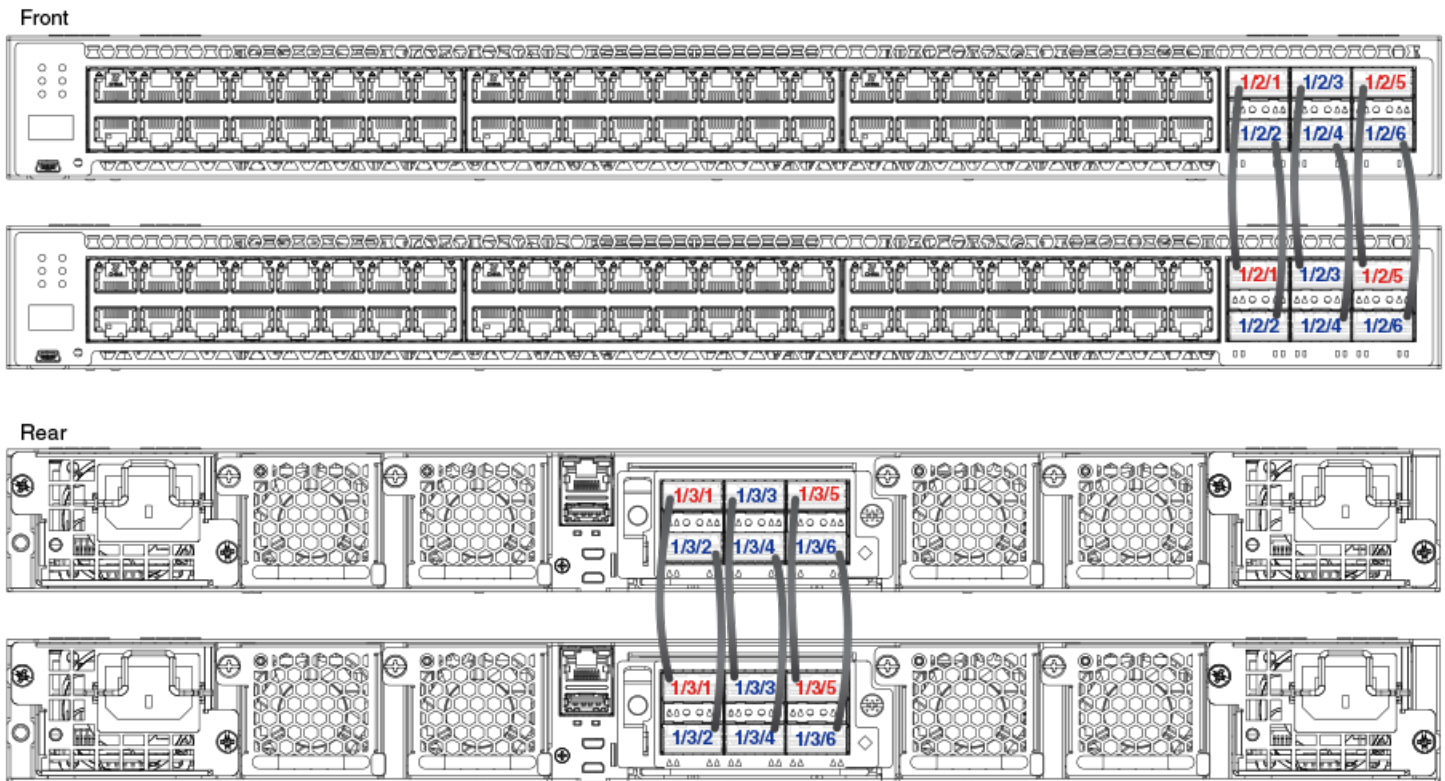

FIGURE 42 ICX 7750-48C two-unit stack with linear-topology trunk (twelve-port trunk)



Installing the ICX 7750 in a remote stack

The ICX 7750-26Q, ICX 7750-48C, and ICX 7750-48F can support stacking distances of 10 kilometers.

To achieve maximum stacking distance, these ICX 7750 models must use Ruckus LR4 fiber optics. LR4 optics require high-power operating mode and an advanced thermal profile to control the fan cooling system. As a result, LR4 optics can be used for stacking only on specific ICX 7750 ports: 1/2/5 and 1/2/6 on module 2 (front panel) or 1/3/5 and 1/3/6 on module 3 (rear panel).

NOTE

The ICX 7750-26Q supports LR4 optics on module 2 ports 1/2/1 through 1/2/6. The stacking cable must be attached to stacking port 1/2/1 or 1/2/4 (refer to the following figure). Port and trunk configuration are otherwise the same as for any ICX 7750 stack.

On an ICX 7750 stack, you can configure stack-port x/2/5, stack-port x/2/6, stack-port x/3/5, stack-port x/3/6, stack-trunk x/2/5 to x/2/6, or stack-trunk x/3/5 to x/3/6. Some combinations are not allowed. For more information, refer to "Valid-stack-port sets" in [ICX 7750 stack configuration overview](#) on page 136.

Port locations for potential stacking ports are shown in the following figures. Although different models are depicted, the port locations are the same on all ICX 7750 units.

FIGURE 43 Module 2 front panel stacking ports (ICX 7750-26Q)

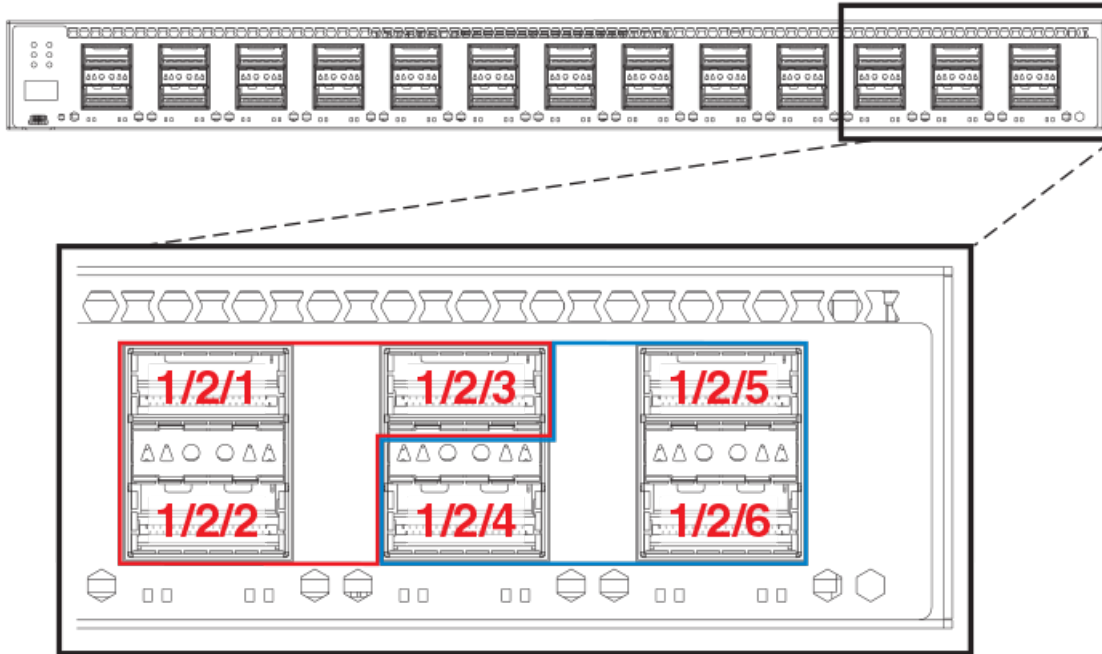

FIGURE 44 Module 2 front panel stacking ports (ICX 7750-48C)

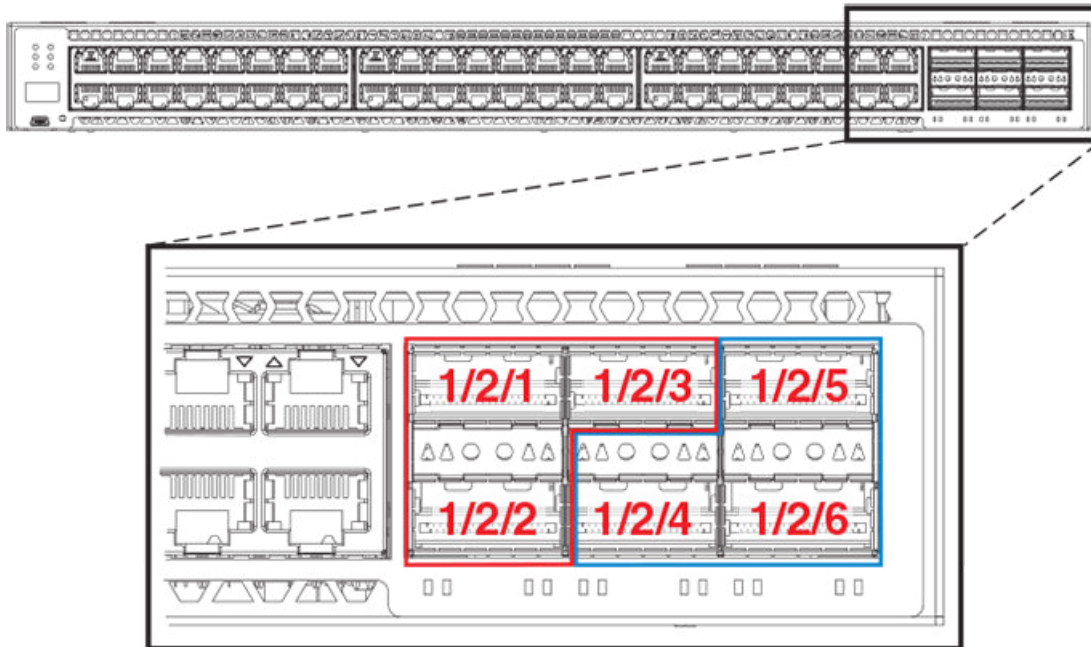
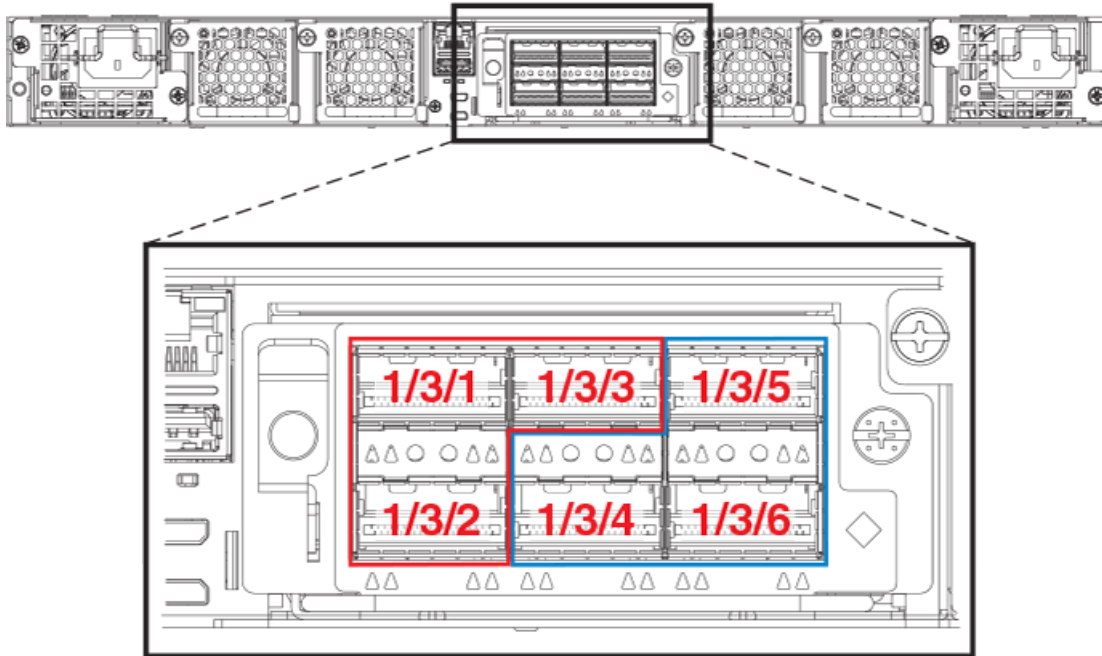

FIGURE 45 Module 3 rear panel stacking ports (ICX 7750-48C)



Refer to [FastIron stacking distances and optics by device](#) on page 50 for information on Ruckus cable options and distances supported by different FastIron models.

ICX 7750 stacking configuration notes

- If an ICX 7750 has a 40-Gbps port configured for breakout into sub-ports, any attempt to enable the unit for stacking will fail. Remove the breakout configuration before enabling stacking on the unit. Refer to the *Ruckus FastIron Management Configuration Guide* for more information on breakout cable configuration.
- When adding a new unit on a linear stack, make sure that the last unit of the existing stack has both stack-ports or stack-trunks configured.
- Unused stacking ports can be used as data ports. For example, you can elect to use only one valid-stack-port as a stacking port and use the other valid-stack-port as a data port. Furthermore, when an ICX 7750 stacking module is not configured for stacking, its stacking ports can be used as data ports. For example, they can be tagged or untagged or configured as breakout ports.
- To configure a stack trunk manually on a stack unit, use the **stack-trunk** command. However, in a live production environment, use the **multi-stack-trunk** command as described in [Creating an ICX 7750 stacking link in a production environment](#) on page 147.
- Only ports that are in sequential order can be configured as a stacking trunk.
- A valid-stack-port, either port 1/2/1 or 1/2/4 in module 2 or port 1/3/1 or 1/3/4 in module 3, is always the first sequential port in a trunk.

ICX 7750 trunk formation during interactive-setup

Stack interactive-setup can discover links between existing units and enlarge stacking trunks. It can detect new links between two end units and change the topology from a chain to a ring. You cannot select partial links. Stack interactive-setup allows only an all-or-none selection.

The following stack interactive-setup example shows the creation of two stacking trunks for a three-unit ICX 7750 stack. One of the new trunks creates a new connection between units 2 and 3, resulting in the formation of a stacking ring.

```
ICX7750-48F Router# show stack
T=21m31.4: alone: standalone, D: dynamic cfg, S: static
ID  Type           Role      Mac Address    Pri State  Comment
1   S ICX7750-48XGF active  609c.9f7f.9400 128 local  Ready
2   S ICX7750-20QXG standby cc4e.2438.7280  0 remote Ready
3   S ICX7750-20QXG member  748e.f8f9.6300  0 remote Ready

      standby           active
      +----+           +----+           +----+
      | 2 |2/1--2/1| 1 |2/4==2/4| 3 |
      +----+           +----+           +----+
Role history: N: standalone, A: active, S: standby, M: member
U1: N->A

Current stack management MAC is 609c.9f7f.9400

ICX7750-48F Router# stack interactive-setup
You can abort stack interactive-setup at any stage by <ctrl-c>
0: quit
1: change stack unit IDs
2: discover and convert new units (no startup-config flash) to members
3: discover and convert existing/new standalone units to members
2&3 can also find new links and auto-trunk or convert chain(s) to ring.
Please type your selection: 2
Probing topology to find clean units...
T=56m18.5: Sending probes to ports: u1: 1/2/2 to 1/2/3, u2: 2/2/2 to 2/2/6, u3: 3/2/1 to 3/2/3,
Existing stack: =====
      standby           active
      +----+           +----+           +----+
      | 2 |2/1--2/1| 1 |2/4==2/4| 3 |
      +----+           +----+           +----+

Stack interactive-setup detects 5 new links (classified to 2 logical links) between existing units.
Logical Link #0: U1--U2: 2 link(s): 1/2/2--2/2/2 1/2/3--2/2/3
It will enlarge (stack-port 1/2/1) to (stack-trunk 1/2/1 to 1/2/3) and enlarge (stack-port 2/2/1) to (stack-trunk 2/2/1 to 2/2/3)

Logical Link #1: U2--U3: 3 link(s): 2/2/4--3/2/1 2/2/5--3/2/2 2/2/6--3/2/3
It will add (stack-trunk 2/2/4 to 2/2/6) and add (stack-trunk 3/2/1 to 3/2/3)
The topology will become a ring.

Do you accept above new link(s)? (enter 'y' or 'n'): y
T=56m44.8: stack interactive-setup configures stack-trunk 2/2/4 to 2/2/6.
T=56m44.9: stack interactive-setup configures stack-trunk 3/2/1 to 3/2/3.

Configuration changed. Please do "write memory".

T=56m45.9: stack interactive-setup configures multi-stack-trunk 1/2/1 to 1/2/3 and 2/2/1 to 2/2/3
stack-trunk 1/2/1 to 1/2/3 replaces stack-port 1/2/1
stack-trunk 2/2/1 to 2/2/3 replaces stack-port 2/2/1

Configuration changed. Please do "write memory".

ICX7750-48F Router#T=56m57.7: Election, was active, no change, ID=1, pri=128, 3U(1-3), A=u1, nbr#=1 1,
reason: u3: stk-po-chg, ,
T=57m1.6: Election, was active, no change, ID=1, pri=128, 3U(1-3), A=u1, nbr#=2 2, reason: u3: port-up, ,

ICX7750-48F Router# show stack
T=57m25.4: alone: standalone, D: dynamic cfg, S: static
ID  Type           Role      Mac Address    Pri State  Comment
```

```

1 S ICX7750-48XGF active 609c.9f7f.9400 128 local Ready
2 S ICX7750-20QXG standby cc4e.2438.7280 0 remote Ready
3 S ICX7750-20QXG member 748e.f8f9.6300 0 remote Ready
  
```

```

          active                standby
          +----+                +----+
=2/1| 1 |2/4==2/4| 3 |2/1==2/4| 2 |2/1=
|   +----+                +----+   |
|   +----+                +----+   |
|-----|
Will assign standby in 38 sec due to all ready
  
```

```

Standby u2 - protocols ready, can failover
Role history: N: standalone, A: active, S: standby, M: member
U1: N->A
  
```

```

Current stack management MAC is 609c.9f7f.9400
  
```

Removing stacking ports from an ICX 7750

Use the **no stack-port** or the **no stack-trunk** command to remove stacking ports from a unit.

NOTE

The **no stack-port** and the **no stack-trunk** commands cannot remove live stacking ports.

The following example removes stack-port 3/2/1, which has no neighbor.

```

ICX7750-48F Router# show stack
T=4h19m31.8: alone: standalone, D: dynamic cfg, S: static
ID  Type           Role      Mac Address      Pri State  Comment
1   S ICX7750-48XGF active  609c.9f7f.9400  128 local  Ready
2   S ICX7750-20QXG standby cc4e.2438.7280  0 remote  Ready
3   S ICX7750-20QXG member  748e.f8f9.6300  0 remote  Ready
  
```

```

standby      active
+----+      +----+      +----+
| 2 |2/1==2/1| 1 |2/4==2/4| 3 |2/1
+----+      +----+      +----+
  
```

```

ICX7750-48F Router# configure terminal
ICX7750-48F Router(config)# stack unit 3
ICX7750-48F Router(config-unit-3)# no stack-port 3/2/1
stack-port 3/2/1 is removed
  
```

Creating an ICX 7750 stacking link in a production environment

The **stack-trunk** command cannot be used to form a trunk manually in a live environment. Instead, use the **multi-stack-trunk** command. The **multi-stack-trunk** command configures both ends of a trunk, based on the range of ports you specify for each side.

NOTE

Configure the same size trunk on either side.

To configure stacking ports in a live system, use the **multi-stack-port** command.

Stacking by Device

ICX 7750 stack configuration overview

In the following example, a port connection is converted to a two-port trunk connection between stack unit 4 and stack unit 5.

```
ICX7750-48F Router# configure terminal
ICX7750-48F Router(config)# stack unit 4
ICX7750-48F Router(config-unit-4)# multi-stack-trunk 4/2/1 to 4/2/2 and 5/2/4 to 5/2/5

stack unit 4
  module 1 icx7750-48-xgf-port-management-module
  module 2 icx7750-qsfp-6port-qsfp-240g-module
  module 3 icx7750-6q-6port-qsfp-240g-module
  stack-trunk 4/2/1 to 4/2/2
  stack-port 4/2/4
stack unit 5
  module 1 icx7750-20-qxg-port-management-module
  module 2 icx7750-qsfp-6port-qsfp-240g-module
  stack-port 5/2/1
  stack-trunk 5/2/4 to 5/2/5
```

The following example creates a stacking link between ports 1/2/1 and 2/2/1 in a live system.

```
ICX7750-48F Router# configure terminal
ICX7750-48F Router(config)# stack unit 2
ICX7750-48F Router(config-unit-2)# multi-stack-port 2/2/1 and 1/2/1
ICX7750-48F Router(config-unit-2)#T=21m22.6: Election, was active, no change, ID=1, pri=128, 3U(1-3), A=u1,
nbr#=1 1,
show run
Current configuration:
!
ver 08.0.90devT203
!
stack unit 1
  module 1 icx7750-48-xgf-port-management-module
  module 2 icx7750-qsfp-6port-qsfp-240g-module
  module 3 icx7750-6q-6port-qsfp-240g-module
  priority 128
  stack-port 1/2/1
  stack-trunk 1/2/4 to 1/2/6
stack unit 2
  module 1 icx7750-20-qxg-port-management-module
  module 2 icx7750-qsfp-6port-qsfp-240g-module
  module 3 icx7750-6q-6port-qsfp-240g-module
  stack-port 2/2/1

stack unit 3
  module 1 icx7750-20-qxg-port-management-module
  module 2 icx7750-qsfp-6port-qsfp-240g-module
  module 3 icx7750-6q-6port-qsfp-240g-module
  stack-trunk 3/2/4 to 3/2/6

stack enable
stack mac 609c.9f7f.9400

ICX7750-48F Router(config-unit-2)# show stack
T=21m31.4: alone: standalone, D: dynamic cfg, S: static
ID  Type          Role      Mac Address    Pri State  Comment
1  S ICX7750-48XGF active   609c.9f7f.9400 128 local  Ready
2  S ICX7750-20QXG standby  cc4e.2438.7280  0 remote Ready
3  S ICX7750-20QXG member   748e.f8f9.6300  0 remote Ready

standby      active
+----+      +----+      +----+
| 2 |2/1--2/1| 1 |2/4==2/4| 3 |
+----+      +----+      +----+
```

Converting an ICX 7750 trunk to a port connection in a live stack

To remove a trunk and create a port connection on a live stack, use the **multi-stack-port** command.

NOTE

Only primary ports (stack module ports 1 and 4) can be designated in the **multi-stack-port** command.

The following code excerpt displays configuration information for stack units 6 and 7.

```
stack unit 6
  module 1 icx7750-20-qxg-port-management-module
  module 2 icx7750-qsfp-6port-qsfp-240g-module
  stack-trunk 6/2/1 to 6/2/3
  stack-port 6/2/4
stack unit 7
  module 1 icx7750-20-qxg-port-management-module
  module 2 icx7750-qsfp-6port-qsfp-240g-module
  stack-port 7/2/1
  stack-trunk 7/2/4 to 7/2/6
```

In the following example, the stacking trunk between units 6 and 7 is changed to a stacking port on each end.

```
ICX7750-48F Router# configure terminal
ICX7750-48F Router(config)# stack unit 6
ICX7750-48F Router(config-unit-6)# multi-stack-port 6/2/1 and 7/2/4
```

NOTE

The **no** form of the **multi-stack-port** command removes port configuration on the designated ports.

Converting an ICX 7750 ring to a linear stack in a live environment

The following example uses the **no multi-stack-trunk** command to remove the connection between stack units 1 and 2, thereby changing the ICX 7750 ring to a three-unit linear stack.

```
ICX7750-48F Router# show stack
T=18m51.7: alone: standalone, D: dynamic cfg, S: static
ID  Type      Role      Mac Address      Pri State  Comment
1   S ICX7750-48XGF active  609c.9f7f.9400  128 local  Ready
2   S ICX7750-20QXG standby cc4e.2438.7280  0 remote Ready
3   S ICX7750-20QXG member  748e.f8f9.6300  0 remote Ready
```

```

      active          standby
+----+          +----+          +----+
=2/1| 1 |2/4==2/4| 3 |2/1==2/4| 2 |2/1=
| +----+          +----+          +----+ |
|-----|
|-----|
```

```
ICX7750-48F Router# configure terminal
ICX7750-48F Router(config)# stack unit 2
ICX7750-48F Router(config-unit-2)# no multi-stack-trunk 2/2/4 to 2/2/6 and 3/2/1 to 3/2/3
ICX7750-48F Router(config-unit-2)#T=20m10.5: Election, was active, no change, ID=1, pri=128, 3U(1-3), A=u1,
nbr#=#1 1, reason: u3: stk-po-chg, ,
```

```
ICX7750-48F Router(config-unit-2)# show stack
T=20m24.7: alone: standalone, D: dynamic cfg, S: static
ID  Type      Role      Mac Address      Pri State  Comment
1   S ICX7750-48XGF active  609c.9f7f.9400  128 local  Ready
2   S ICX7750-20QXG standby cc4e.2438.7280  0 remote Ready
3   S ICX7750-20QXG member  748e.f8f9.6300  0 remote Ready
```

```

standby          active
+----+          +----+          +----+
| 2 |2/1==2/1| 1 |2/4==2/4| 3 |
+----+          +----+          +----+
```

Restoring a data port from an ICX 7750 trunk in a live stack

The **multi-stack-trunk** command can be used to remove a stacking port for configuration as a data port.

Use the following procedure in a production environment to reduce the size of a trunk and make an end port in the trunk available for configuration as a data port.

The following example reconfigures a six-port trunk between module 2 of stack units 1 and 2.

1. From the active controller for the stack, enter stack-unit configuration mode for a device at one end of the trunk.

```
ICX7750-48F Router(config)# stack unit 1
```

2. In stack-unit configuration mode, enter the **multi-stack-trunk** command. Specify the new, smaller port range for the trunk on both ends (stack-unit 1 and stack-unit 2 in the following example). Be sure the port numbers are correct and the size of the trunk is the same on both ends.

```
ICX7750-48F Router(config-unit-1)# multi-stack-trunk 1/2/1 to 1/2/5 and 2/2/1 to 2/2/5
```

The end port of the trunk on each stack unit is dropped from the trunk and is available for configuration on each of the units.

3. Configure one or both of the ports as appropriate.

In the following example, port 2/2/6, which was previously part of a six-port trunk between stack unit 1 and stack unit 2, is ready to configure as a data port.

```
ICX7750-48F Router(config)# interface ethernet 2/2/6
Error - command not allowed for stacking port: 2/2/6
```

```
ICX7750-48F Router(config)# stack unit 1
ICX7750-48F Router(config-unit-1)# multi-stack-trunk 1/2/1 to 1/2/5 and 2/2/1 to 2/2/5
```

```
ICX7750-48F Router(config-unit-1)#interface ethernet 2/2/6
ICX7750-48F Router(config-if-e40000-2/2/6)#
```

ICX 7850 stack configuration overview

The following table provides an overview of ICX 7850 stacking capabilities.

TABLE 25 ICX 7850 stacking capability

Stacking capability	ICX 7850	Additional information
Topologies supported	Ring and linear	Refer to ICX 7850 stacking topologies for more information.
Maximum stack size	12	Stacking only.
Maximum stacking distance	10 kilometers	Refer to FastIron stacking distances and optics by device on page 50 for more information.
ICX 7850 model combinations	Allowed (all models)	ICX 7850-48F, ICX 7850-48FS, and ICX 7850-32Q models can be combined in the same stack.
Stacking ports	8 X 100 Gbps or 8 X 40 Gbps ICX 7850-32Q: ports 1/3/1 to 1/3/8 ICX 7850-48FS/48F: ports 1/2/1 to 1/2/8	Stacking port speeds are auto-detect.

TABLE 25 ICX 7850 stacking capability (continued)

Stacking capability	ICX 7850	Additional information
Valid-stack-port sets	<p>ICX 7850-32Q: (x/3/1, x/3/5, 4)</p> <p>ICX 7850-48FS/48F: (x/2/1, x/2/5, 4)</p> <p>NOTE The third number in the set is the maximum number of ports in a stacking trunk. The number "1" indicates a single stack-port only.</p>	<p>Refer to the definition of valid-stack-port set in Stacking terminology on page 19 and Valid-stack-port sets on page 23 for more information.</p> <p>Refer to ICX 7850 stacking topologies on page 151 for port locations.</p>
Reconfigurable ports	Use the and stack-port and stack-trunk commands to reconfigure ports.	Stacking port speeds are auto-detect and cannot be configured.
Trunks	<p>The following maximum stacking trunk configurations are supported:</p> <p>ICX 7850-32Q: stack-trunk 1/3/1 to 1/3/4 or stack-trunk 1/3/5 to 1/3/8</p> <p>ICX 7850-48FS/48F: stack-trunk 1/2/1 to 1/2/4 or 1/2/5 to 1/2/8</p>	See also "Linear-topology trunks" in this table.
Linear-topology trunks	<p>The following maximum linear-topology trunks are supported:</p> <p>ICX 7850-32Q: stack-trunk x/3/1 to x/3/8</p> <p>ICX 7850-48FS/48F: stack-trunk x/2/1 to x/2/8</p>	Refer to Support for two-unit stack linear-topology trunks on page 36 for more information.
Hitless switchover and hitless failover	Supported	Refer to Hitless stacking on page 171.
License requirements	No license required for stack-port configuration. No license required for Premium features.	For more information on ICX 7850 license options, refer to the <i>Ruckus FastIron Software Licensing Guide</i> .
Configuration options	Manual and automatic, including stack interactive-setup and stack zero-touch provisioning	Refer to Stack construction methods on page 56.
Access methods	TFTP, SCP	Software images, boot images, and signatures can be downloaded to a stack using TFTP and SCP applications. Refer to the <i>Ruckus FastIron Software Upgrade Guide</i> for more information.
Stacking commands	All stacking CLI is supported.	

ICX 7850 stacking topologies

The following figures show available ICX 7850 stacking ports on the front panel. On ICX 7850-32Q devices, valid-stack-ports are 1/3/1 and 1/3/5 and available stacking ports are 1/3/1 through 1/3/8. On ICX 7850-48F and ICX 7850-48FS devices, stacking ports are in the same location on the front panel; however, the module is number 2. Valid-stack-ports on ICX 7850-48F and ICX 7850-48FS are 1/2/1 and 1/2/5 and available stacking ports are 1/2/1 through 1/2/8.

FIGURE 46 ICX 7850-32Q stacking ports

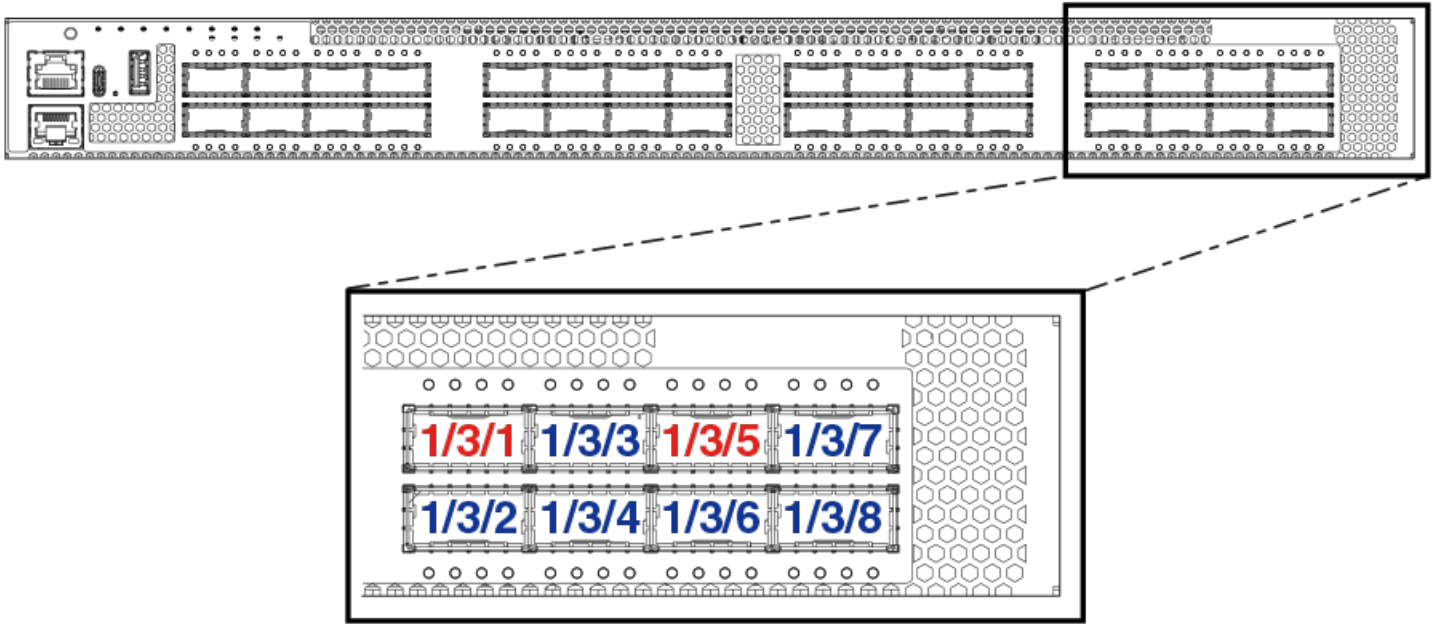
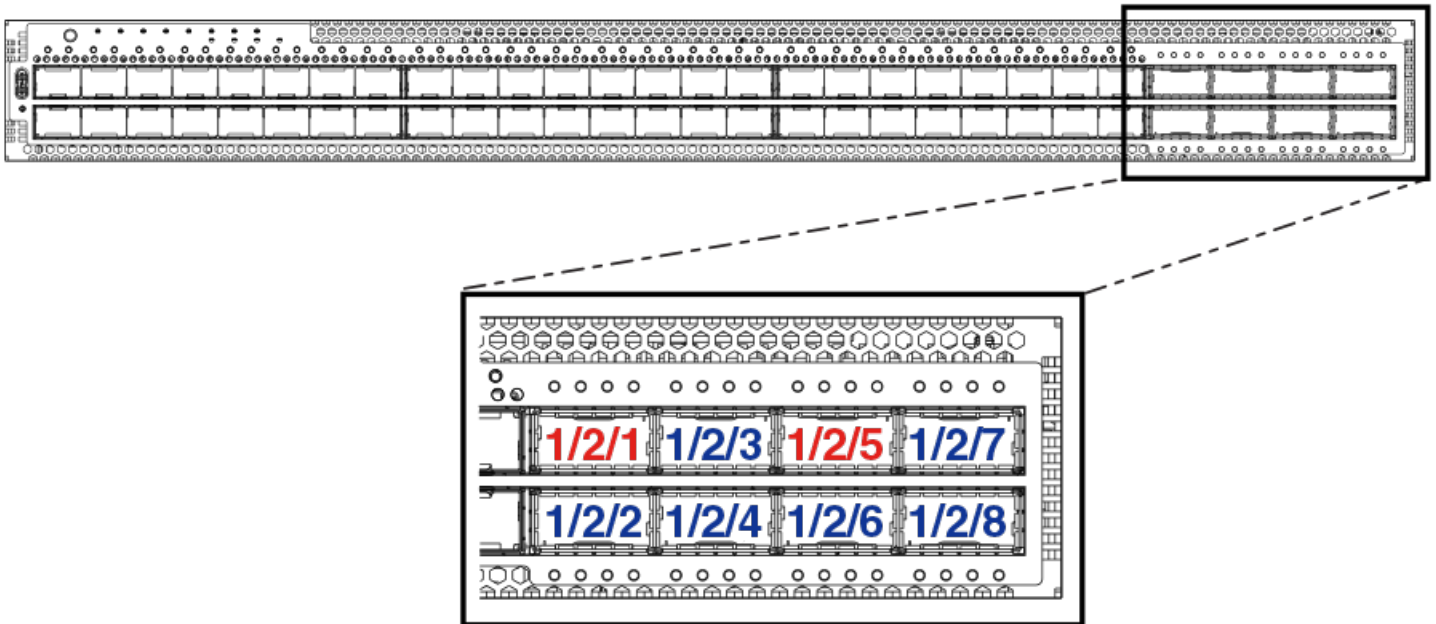
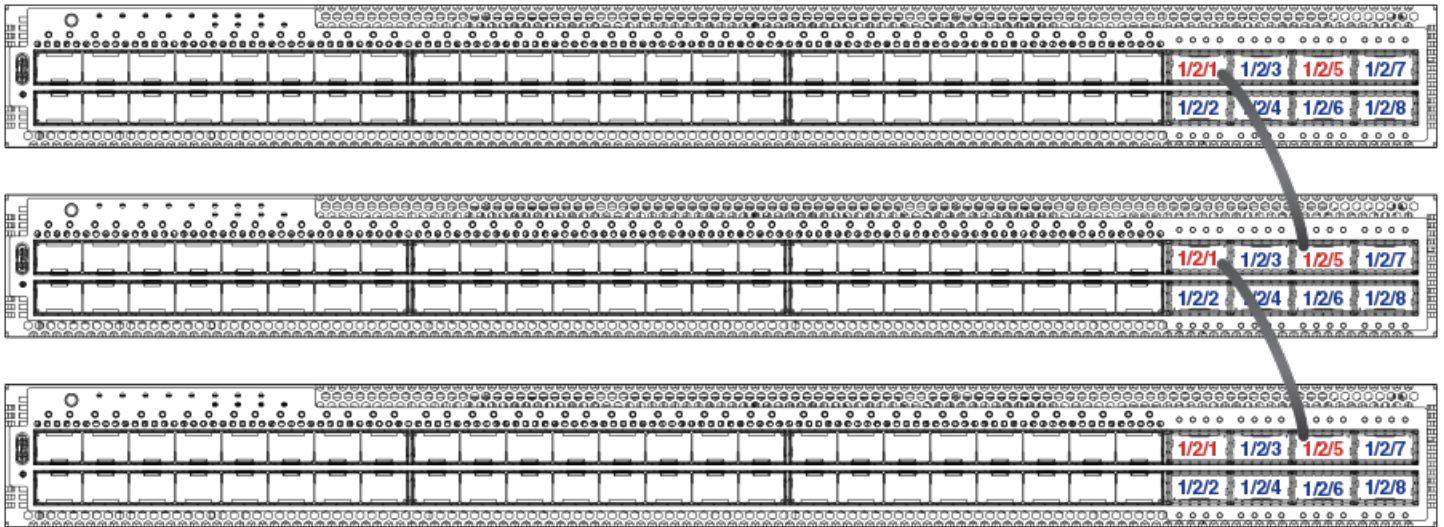

FIGURE 47 ICX 7850-48F/48FS stacking ports



The following figure shows an ICX 7850 linear stack.

FIGURE 48 ICX 7850-48F/48FS linear topology



The following figure shows an ICX 7850-48F/48FS stack connected in a ring topology.

FIGURE 49 ICX 7850-48F/48FS ring topology

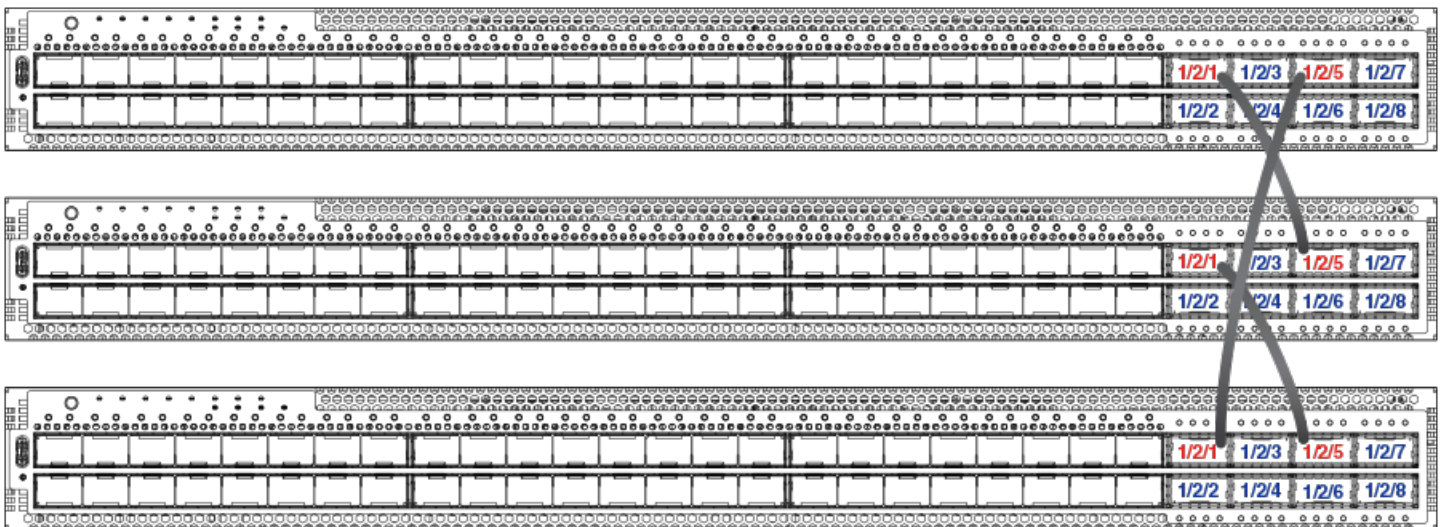

ICX 7850 two-unit stacks with linear-topology trunks

The following figure depicts a two-unit stack linear-topology trunk in an ICX 7850-48FS stack. ICX 7850-32Q stacks are cabled the same way, but the ICX 7850-32Q uses slot 3 for stacking as shown in the port location graphic for that model. All ICX 7850 models support this type of trunk, which improves redundancy and bandwidth. For more information, refer to [Support for two-unit stack linear-topology trunks](#) on page 36.

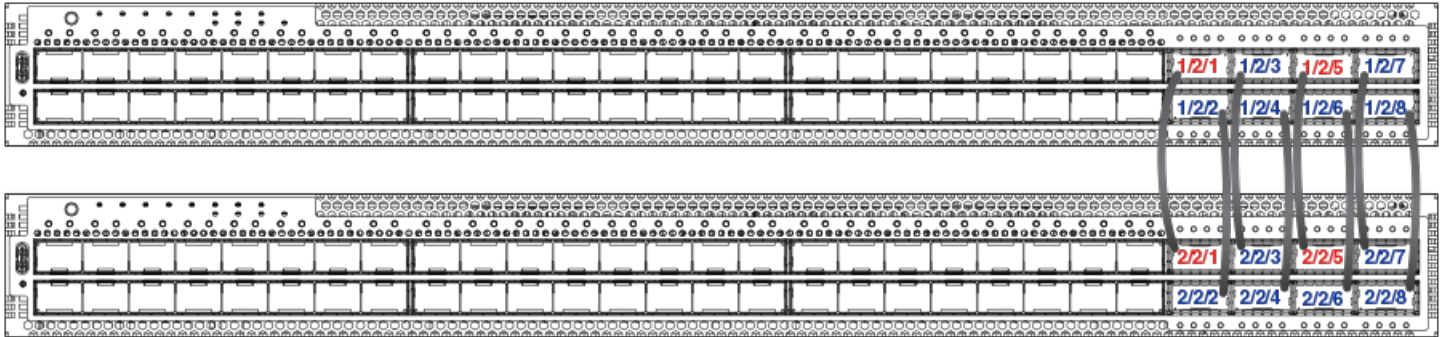
FIGURE 50 ICX 7850-48FS two-unit stack with linear-topology trunk (eight ports)

ICX 7850 configuration notes

Keep the following points in mind when configuring ICX 7850 stack units.

- If an ICX 7850 unit has any port configured for breakout into sub-ports, any attempt to enable the unit for stacking will fail. Remove the breakout configuration before enabling stacking on the unit. Refer to the *Ruckus FastIron Management Configuration Guide* for more information on breakout cable configuration.
- When using the manual construction method to add a new unit in a linear stack, make sure that the last unit of the existing stack has both stack-ports or stack-trunks configured.
- Unused stacking ports can be used as data ports. For example, you can elect to use only one valid-stack-port as a stacking port and the other valid-stack-port as a data port. Furthermore, when an ICX 7850 stacking module is not configured for stacking, its stacking ports can be used as data ports.
- To configure a stacking trunk manually on a stack unit, use the **stack-trunk** command. However, in a live production environment, use the **multi-stack-trunk** command as described in [Creating an ICX 7750 stacking link in a production environment](#) on page 147.
- Only ports that are in sequential order can be configured as a stacking trunk.
- In a stacking system with two directions, ICX 7850 stacks support a maximum of four ports per trunk in one direction. As an exception, a linear-topology trunk in a two-unit stack may contain up to eight ports.
- Stacking port speed is either 40-Gbps or 100-Gbps and is auto-detected based on the optics connected. Speed cannot be manually configured.
- It is allowable (but not advised) to have a 100-Gbps trunk or port in one direction and a 40-Gbps trunk or port in another direction.
- Ruckus recommends that you keep the same stacking link bandwidth across the stack.
- Ruckus recommends that all ports in the same stacking trunk be the same speed. When ports with different speeds are in the same trunk, a warning message is displayed in the output of the **show stack** command as shown in the following example.

```
ICX7850-32Q Router# configure terminal
ICX7850-32Q Router(config)# stack unit 1
ICX7850-32Q Router(config-unit-1)# show stack
ID   Type           Role      Mac Address    Pri State  Comment
1   S ICX7850-32Q   active    903a.7205.06b0  0 local  Ready
2   S ICX7850-48FS member    903a.7205.3800  0 remote Ready
3   S ICX7850-48F  standby  903a.7205.4250  0 remote Ready
    active        standby
    +---+        +---+        +---+
=3/1| 1 |3/5--2/1| 3 |2/5==2/1| 2 |2/5=
|   +---+        +---+        +---+ |
```

```
|-----|  
Warning: inconsistent stacking trunk port speed was found in:  
stack-trunk 1/3/1 to 1/3/4 has different speed 100Gbit/40Gbit :  
1/3/1 in speed 100Gbit  
1/3/2 in speed 100Gbit  
1/3/3 in speed 40Gb
```

Creating a two-unit ICX 7850 stack with a linear-topology trunk using stack interactive-setup

Complete the following steps to use stack interactive-setup to create a two-unit ICX 7850 stack with a linear-topology trunk.

1. In global configuration mode on the unit that will server as the active controller, enter the **stack enable** command to enable stacking.

```
ICX7850-32Q Router# configure terminal  
ICX7850-32Q Router(config)# stack enable  
Enable stacking. This unit actively participates in stacking  
ICX7850-32Q Router(config)# end
```

- On the active controller, enter the **stack interactive-setup** command. When prompted to select an option, select 2 if the new unit is a clean unit to discover and convert new units to stack members. To keep the proposed configuration, enter **y** when prompted.

NOTE

If you attempt to run stack interactive-setup immediately after enabling stacking, the following message may be displayed: T=3m37.8: Some ports are in HighGig mode. Please try again in 30 seconds.

In the following example, all eight ports (1/3/1 to 1/3/8) are connected to the peer unit.

```
ICX7850-32Q Router# stack interactive-setup
You can abort stack interactive-setup at any stage by <ctrl-c>
0: quit
1: change stack unit IDs
2: discover and convert new units (no startup-config flash) to members
3: discover and convert existing/new standalone units to members
2&3 can also find new links and auto-trunk or convert chain(s) to ring.
Please type your selection: 2
Probing topology to find clean units...
T=5m14.1: Sending probes to ports: u1: 1/3/1 to 1/3/8,
Existing stack: =====

  +---+
 3/1| 1 |3/5
  +---+

Horizontal bars link to discovered units. Vertical bars link to stack units.

Chain #0: =====
#1: icx7850-48fs-port-management d4c1.9e18.8dd9

  1/3/1
  ||
  ||
  2/1
  +---+
  |#1 |
  +---+

Discovered 1 chain/ring
Chain #0: Do you want to select this chain? (enter 'y' or 'n'): y
```

- Press **Enter** to accept the default ID, or type an alternative ID.

In the following example, the user elected to use the default ID.

```
1: icx7850-48fs-port d4c1.9e18.8dd9, type an ID (No: 0, default: 2):
You selected 1 unit(s): #1: ID=2,
Links U1--U2, #=8: 3/1--2/1, 3/2--2/2, 3/3--2/3, 3/4--2/4, 3/5--2/5, 3/6--2/6, 3/7--2/7, 3/8--2/8,
```

- If the topology qualifies as a linear-topology trunk, you are given the option of selecting the linear-topology chain (enter **n**) or a ring topology (enter **y**).

In the following example, a linear-topology trunk is selected.

```
There are total two units. The connections qualify a linear-topo that puts all discovered links to a trunk.
Do you want a ring? (y: ring, n: linear-topo chain) (enter 'y' or 'n'): n
```

```

          #1
    +----+   +----+
    | 1 |3/1==2/1| 2 |
    +----+   +----+
```

- When prompted to accept the topology, enter **y** (or type **n** to terminate the process).

```
Proceeding will produce the above topology. Do you accept it? (enter 'y' or 'n'): y
stack interactive-setup discovers 1 unit(s) and sends stack-port/trunk to chain 0: linear-topo: 2/1
to 2/8
```

```
stack-trunk 1/3/1 to 1/3/8 replaces stack-port 1/3/1 and stack-port 1/3/5
```

After you accept the topology, the second stack unit reloads, and stack formation is completed. You are prompted to enter the **write memory** command.

```
Configuration changed. Please do "write memory".
```

```
ICX7850-32Q Router#T=11m12.7: Election, was alone --> active, ID=1, pri=128, 2U(1-2), A=u1, nbr#=1
0, reason: u2: port-up, ,
Debug: Dec 13 22:12:21 Detect stack unit 2 has different ssh rsahost key, will synchronize it
Debug: Dec 13 22:12:21 T=11m13.2: Synchronize webauth files to u2
T=11m14.7: Done hot swap: active controller u1 sets u2 to Ready.
T=11m15.2: Election, was active, no change, ID=1, pri=128, 2U(1-2), A=u1, nbr#=1 0, reason: u1: stk-
po-chg, ,
Stack unit 2 Power supply 1 is up
Stack unit 2 Power supply 2 is not present
Debug: Dec 13 22:12:28
Config changed due to add/del units. Do write mem if you want to keep it
Debug: Dec 13 22:12:31 T=11m23.2: Synchronize ssh rsa host key to u2
T=12m15.9: Assigned unit 2 to be standby
Debug: Dec 13 22:13:26 T=12m17.9: start running config sync to standby u2
Debug: Dec 13 22:13:26 T=12m18.6: Running config sync to standby u2 is complete
```

- Enter the **write memory** command to save the configuration.

```
ICX7850-32Q Router# write memory

There is no startup config file, unable to save legacy config
Flash Memory Write (8192 bytes per dot)
Write startup-config done.

Automatic copy to member units: 2
Flash Memory Write (8192 bytes per dot)
.
Copy Done.
```

7. (Optional) Enter the **show stack** command and the **show running-config** command to check the stack configuration.

```

ICX7850-32Q Router# show stack
T=12m52.2: alone: standalone, D: dynamic cfg, S: static
ID  Type      Role      Mac Address  Pri State  Comment
1   S ICX7850-32Q active d4c1.9e18.3731 128 local  Ready
2   S ICX7850-48FS standby d4c1.9e18.8dd9 0 remote Ready

      standby      active
      +----+      +----+
      | 2 |2/1==3/1| 1 |
      +----+      +----+
Standby u2 - Learn other units for 31 sec, protocols may not be ready in 39 s.
Role history: N: standalone, A: active, S: standby, M: member
U1: N->A

ICX7850-32Q Router# show running-config
Current configuration:
!
ver 08.0.90_b313T233
!
stack unit 1
  module 1 icx7850-32q-port-management-module
  module 2 icx7800-100g-12port-1200g-module
  module 3 icx7800-100g-8port-800g-module
  priority 128
  stack-trunk 1/3/1 to 1/3/8

stack unit 2
  module 1 icx7850-48fs-port-management-module
  module 2 icx7800-100g-8port-800g-module
  stack-trunk 2/2/1 to 2/2/8

stack enable
stack mac d4c1.9e18.3731
!
!
aaa authentication web-server default local
aaa authentication login default local
enable aaa console
!
no telnet server
username super password .....
!
!
hitless-failover enable
!
!
sz registrar
!
!
end

```

Using stack zero-touch provisioning to create a two-unit ICX 7850 stack with a ring topology

Before using stack zero-touch provisioning, check all connections to make sure they are correct.

Complete the following steps to create a two-unit ICX 7850 ring using stack zero-touch provisioning.

1. (Optional) Enter the **show running-config** command to check unit configuration on the proposed active controller unit.

```
ICX7850-32Q Router# show running-config
Current configuration:
!
ver 08.0.90_b313T233
!
stack unit 1
  module 1 icx7850-32q-port-management-module
  module 2 icx7800-100g-12port-1200g-module
  module 3 icx7800-100g-8port-800g-module
  stack-port 1/3/1
  stack-port 1/3/5
!
!
aaa authentication web-server default local
aaa authentication login default local
enable aaa console
!
no telnet server
username super password .....
!
!
sz registrar
!
!
end
ICX7850-32Q Router#
```

2. In global configuration mode on the unit that will serve as the active controller, enter the **stack enable** command to enable stacking.

```
ICX7850-32Q Router# configure terminal
ICX7850-32Q Router(config)# stack enable
Enable stacking. This unit actively participates in stacking
```

3. Enter the **stack zero-touch-enable** command.

```
ICX7850-32Q Router(config)# stack zero-touch-enable
```

4. (Optional) Enter the **show stack zero-touch status** command to check the available configuration options.

```
ICX7850-32Q Router# show stack zero-touch status
I cannot be discovered by stack zero-touch or interactive-setup option 2. reason: has stack enable
configuration
I can be discovered by stack interactive-setup option 3.
Has no unit-replacement timer. trig=2, reason=has stack zero-touch-enable
zero-touch-enable and stack enable are configured. Have done 0 probes
ZTP has converted 0 new units to members.
zero-touch-enable period: 3 minutes. Will trigger in 0 min 16 sec
ZTP postponed due to topology changes: 0
My MAC used in image copy is 748e.f8f9.636e.
ACL #=0, ind=0
```

The stack zero-touch provisioning process sends probes to ports 1/3/1 through 1/3/8 and discovers the ring topology.

```
ICX7850-32Q Router#T=7m4.0: Sending probes to ports: u1: 1/3/1 to 1/3/8,
stack zero-touch detects the following links:
Links U1--U2, #=8: 3/1--2/1, 3/2--2/2, 3/3--2/3, 3/4--2/4, 3/5--2/5, 3/6--2/6, 3/7--2/7, 3/8--2/8,
```

```

          #1
      +----+      +----+
=3/1| 1 |3/5==2/5| 2 |2/1=
| +----+      +----+ |
|-----|

```

```
stack zero-touch discovers 1 unit(s) and sends stack-port/trunk to chain 0:
#1 d4c1.9e18.8dd9 U2, D0: 2/1 to 2/4, D1: 2/5 to 2/8
```

```
stack-trunk 1/3/5 to 1/3/8 replaces stack-port 1/3/5
stack-trunk 1/3/1 to 1/3/4 replaces stack-port 1/3/1
T=7m26.2: stack zero-touch enlarges stack-port 1/3/5 to stack-trunk 1/3/5 to 1/3/8 to match links.
stack zero-touch adds stack-trunk 1/3/1 to 1/3/4 for new units to join
Configuration changed. Please do "write memory".
```

The other unit reloads as a stack member, and stack formation is complete.

```
ICX7850-32Q Router#T=12m47.5: Election, was alone --> active, ID=1, pri=128, 2U(1-2), A=u1, nbr#=1
1, reason: u2: port-up, ,
Debug: Dec 13 22:31:33 Detect stack unit 2 has different ssh rsaost key, will synchronize it
Debug: Dec 13 22:31:33 T=12m47.9: Synchronize webauth files to u2
T:12m49.4: Done hot swap: active controller u1 sets u2 to Ready.
T=12m49.9: Election, was active, no change, ID=1, pri=128, 2U(1-2), A=u1, nbr#=1 1, reason: u1: stk-
po-chg, ,
Stack unit 2 Power supply 1 is up
Stack unit 2 Power supply 2 is not present
Debug: Dec 13 22:31:40
Config changed due to add/del units. Do write mem if you want to keep it
Debug: Dec 13 22:31:43 T=12m57.9: Synchronize ssh rsa host key to u2
T=13m50.6: Assigned unit 2 to be standby
Debug: Dec 13 22:32:38 T=13m52.6: start running config sync to standby u2
Debug: Dec 13 22:32:38 T=13m53.3: Running config sync to standby u2 is complete
```

5. Enter the **write memory** command to save the configuration.

```
ICX7850-32Q Router# write memory

There is no startup config file, unable to save legacy config
Flash Memory Write (8192 bytes per dot)
Write startup-config done.

Automatic copy to member units: 2
Flash Memory Write (8192 bytes per dot)
.
Copy Done.
```

6. (Optional) Enter the **show stack** command and the **show running-config** command to check the stack configuration.

```

ICX7850-32Q Router# show stack
T=14m59.3: alone: standalone, D: dynamic cfg, S: static
ID   Type           Role   Mac Address   Pri State   Comment
1   S ICX7850-32Q   active d4c1.9e18.3731 128 local   Ready
2   S ICX7850-48FS  standby d4c1.9e18.8dd9  0 remote Ready

      active           standby
      +----+         +----+
=3/5| 1 |3/1==2/1| 2 |2/5=
|   +----+         +----+ |
|-----|
Standby u2 - Learn other units for 63 sec, protocols may not be ready in 7 s.
Role history: N: standalone, A: active, S: standby, M: member
U1: N->A

Current stack management MAC is d4c1.9e18.3731

ICX7850-32Q Router# show running-config
Current configuration:
!
ver 08.0.90_b313T233
!
stack unit 1
  module 1 icx7850-32q-port-management-module
  module 2 icx7800-100g-12port-1200g-module
  module 3 icx7800-100g-8port-800g-module
  priority 128
  stack-trunk 1/3/1 to 1/3/4
  stack-trunk 1/3/5 to 1/3/8
stack unit 2
  module 1 icx7850-48fs-port-management-module
  module 2 icx7800-100g-8port-800g-module
  stack-trunk 2/2/1 to 2/2/4
  stack-trunk 2/2/5 to 2/2/8
stack enable
stack zero-touch-enable
stack mac d4c1.9e18.3731
!
!
aaa authentication web-server default local
aaa authentication login default local
enable aaa console
!
no telnet server
username super password .....
!
!
!
hitless-failover enable
!
!
sz registrar
!
!
end

```

Creating a linear-topology trunk on a two-unit ICX 7850 stack in a live environment

NOTE

If you try to expand a four-port trunk to an eight-port linear-topology trunk using stack Interactive setup, the default result would be a ring topology with two four-port trunks. The preferred method to create a linear-topology trunk is to use the **multi-stack-trunk** command.

Complete the following steps to create a two-unit ICX 7850 stack with a linear-trunk topology in a production environment.

1. (Optional) Enter the **show stack** command and the **show running-config** command to check the stack configuration.

```
ICX7850-32Q Router# stack interactive-setup
You can abort stack interactive-setup at any stage by <ctrl-c>
0: quit
1: change stack unit IDs
2: discover and convert new units (no startup-config flash) to members
3: discover and convert existing/new standalone units to members
2&3 can also find new links and auto-trunk or convert chain(s) to ring.
Please type your selection: 3
Probing topology to find standalone units...
T=16m15.1: Sending probes to ports: u1: 1/3/5 to 1/3/8, u2: 2/2/5 to 2/2/8,
Existing stack: =====
      standby      active
      +----+      +----+
      | 2 |2/1==3/1| 1 |
      +----+      +----+

Stack interactive-setup detects 4 new links (classified to 1 logical link) between existing units.
Logical Link #0: U1--U2: 4 link(s): 1/3/5--2/2/5 1/3/6--2/2/6 1/3/7--2/2/7 1/3/8--2/2/8
It will add (stack-trunk 1/3/5 to 1/3/8) and add (stack-trunk 2/2/5 to 2/2/8)
The topology will become a ring.

Do you accept above new link(s)? (enter 'y' or 'n'): n
```

The following example shows a two-unit stack with a four-port stacking trunk.

```
ICX7850-32Q Router# show stack
T=16m0.6: alone: standalone, D: dynamic cfg, S: static
ID  Type      Role      Mac Address      Pri State      Comment
1   S ICX7850-32Q active d4c1.9e18.3731 128 local      Ready
2   S ICX7850-48FS standby d4c1.9e18.8dd9 0 remote    Ready

      standby      active
      +----+      +----+
      | 2 |2/1==3/1| 1 |
      +----+      +----+

Will assign standby in 55 sec due to all ready

Standby u2 - protocols ready, can failover
Role history: N: standalone, A: active, S: standby, M: member
U1: N->A

Current stack management MAC is d4c1.9e18.3731

ICX7850-32Q Router# show running-config
Current configuration:
!
ver 08.0.90_b313T233
!
stack unit 1
  module 1 icx7850-32q-port-management-module
  module 2 icx7800-100g-12port-1200g-module
  module 3 icx7800-100g-8port-800g-module
  priority 128
  stack-trunk 1/3/1 to 1/3/4

stack unit 2
  module 1 icx7850-48fs-port-management-module
  module 2 icx7800-100g-8port-800g-module
  stack-trunk 2/2/1 to 2/2/4

stack enable
stack mac d4c1.9e18.3731
!
!
aaa authentication web-server default local
aaa authentication login default local
```

Stacking by Device

ICX 7850 stack configuration overview

```
enable aaa console
!  
no telnet server
username super password .....
!  
!  
hitless-failover enable
!  
!  
sz registrar
!  
!  
End
```

2. In stack unit configuration sub-mode, enter the **multi-stack-trunk** command followed by the range of ports on both ends of a connection to form the desired stacking trunk. To create a full linear-topology trunk, enter the full range of eight ports on both end as shown in the following example.

The example expands the existing four-port trunk to an eight-port trunk.

```
ICX7850-32Q Router# configure terminal
ICX7850-32Q Router(config)# stack unit 1
ICX7850-32Q Router(config-unit-1)# multi-stack-trunk 1/3/1 to 1/3/8 and 2/2/1 to 2/2/8
stack-trunk 1/3/1 to 1/3/8 replaces stack-trunk 1/3/1 to 1/3/4
stack-trunk 2/2/1 to 2/2/8 replaces stack-trunk 2/2/1 to 2/2/4
ICX7850-32Q Router(config-unit-1)# end

You selected 0 unit(s):
No unit is selected.
ICX7850-32Q Router#T=18m53.8: Election, was active, no change, ID=1, pri=128, 2U(1-2), A=u1, nbr#=1
0,
```

3. Enter the **write memory** command to save the configuration.

```
ICX7850-32Q Router# write memory
Flash Memory Write (8192 bytes per dot)
Write startup-config done.

Automatic copy to member units: 2
Flash Memory Write (8192 bytes per dot)
.
Copy Done.
```

4. (Optional) Enter the **show stack** command and the **show running-config** command to check that the topology has changed from a four-port trunk to an eight-port linear-topology trunk.

```

ICX7850-32Q Router# show stack
T=19m38.6: alone: standalone, D: dynamic cfg, S: static
ID  Type           Role   Mac Address   Pri State  Comment
1   S ICX7850-32Q     active d4c1.9e18.3731 128 local  Ready
2   S ICX7850-48FS   standby d4c1.9e18.8dd9  0 remote Ready

      standby           active
      +----+           +----+
      | 2 |2/1==3/1| 1 |
      +----+           +----+
Will assign standby in 19 sec due to all ready

Standby u2 - protocols ready, can failover
Role history: N: standalone, A: active, S: standby, M: member
U1: N->A

Current stack management MAC is d4c1.9e18.3731

ICX7850-32Q Router# show running-config
Current configuration:
!
ver 08.0.90_b313T233
!
stack unit 1
  module 1 icx7850-32q-port-management-module
  module 2 icx7800-100g-12port-1200g-module
  module 3 icx7800-100g-8port-800g-module
  priority 128
  stack-trunk 1/3/1 to 1/3/8

stack unit 2
  module 1 icx7850-48fs-port-management-module
  module 2 icx7800-100g-8port-800g-module
  stack-trunk 2/2/1 to 2/2/8

stack enable
stack mac d4c1.9e18.3731
!
!
aaa authentication web-server default local
aaa authentication login default local
enable aaa console
!
no telnet server
username super password .....
!
!
hitless-failover enable
!
!
sz registrar
!
!
End

```

Manually creating a two-unit ICX 7850 stack with a ring topology

Perform the following steps to manually create a two-unit ICX 7850 stack with a ring topology.

1. (Optional) Enter the **show running-config** command on each stack unit to check its current configuration.

The following example shows two stacking units each with stacking ports configured.

```
Unit 1:
ICX7850-32Q Router# show running-config
Current configuration:
!
ver 08.0.90_b313T233
!
stack unit 1
  module 1 icx7850-32q-port-management-module
  module 2 icx7800-100g-12port-1200g-module
  module 3 icx7800-100g-8port-800g-module
  stack-port 1/3/1
  stack-port 1/3/5
!
!
aaa authentication web-server default local
aaa authentication login default local
enable aaa console
!
no telnet server
username super password .....
!
!
sz registrar
!
!
End

Unit 2:
ICX7850-48FS Router# show running-config
Current configuration:
!
ver 08.0.90_b313T233
!
stack unit 1
  module 1 icx7850-48fs-port-management-module
  module 2 icx7800-100g-8port-800g-module
  stack-port 1/2/1
  stack-port 1/2/5
!
!
aaa authentication web-server default local
aaa authentication login default local
enable aaa console
!
no telnet server
username super password .....
!
!
sz registrar
!
!
End
```

2. Manually configure the desired stack-ports or stack-trunks on the two candidate stack units. To configure a ring, configure two potential connections on each unit.

The following example creates two four-port stacking trunks on each stacking candidate.

```
Unit 1:
ICX7850-32Q Router# configure terminal
ICX7850-32Q Router(config)# stack unit 1
ICX7850-32Q Router(config-unit-1)# stack-trunk 1/3/1 to 1/3/4
stack-trunk 1/3/1 to 1/3/4 replaces stack-port 1/3/1
ICX7850-32Q Router(config-unit-1)# stack unit 1
ICX7850-32Q Router(config-unit-1)# stack-trunk 1/3/5 to 1/3/8
stack-trunk 1/3/5 to 1/3/8 replaces stack-port 1/3/5

Unit 2:
ICX7850-48FS Router# configure terminal
ICX7850-48FS Router(config)# stack unit 1
ICX7850-48FS Router(config-unit-1)# stack-trunk 1/2/1 to 1/2/4
stack-trunk 1/2/1 to 1/2/4 replaces stack-port 1/2/1
ICX7850-48FS Router(config-unit-1)# stack-trunk 1/2/5 to 1/2/8
stack-trunk 1/2/5 to 1/2/8 replaces stack-port 1/2/5
ICX7850-48FS Router(config-unit-1)# end
```

Stacking by Device

ICX 7850 stack configuration overview

3. Enter the **stack enable** command on both the units to enable stacking.

```
Unit 1:
ICX7850-32Q Router# configure terminal
ICX7850-32Q Router(config)# stack enable
Enable stacking. This unit actively participates in stacking
```

```
Unit 2:
ICX7850-48FS Router# configure terminal
ICX7850-48FS Router(config)# stack enable
Enable stacking. This unit actively participates in stacking
```

Stack active controller election occurs on the connected units, and the second units reloads to join to the stacking system.

```
T=22m0.6: Election, was alone --> member, ID=2, pri=0, 2U(1-2), A=u1, nbr#=1 1, reason: u1: stk-po-
chg, ,
My assigned ID is 2, but my bootup ID is 1, need reload
```

```
[MEMBER]local-1@ICX7850-48FS Router>T=22m3.6: Boot request from u1 mac=d4c1.9e18.3731, my ID=2,
reason: u2 bootup-id=1, flash: Primary, jumbo=0,
Copy RAMFS console log file to flash before we shutdown
Copy RAMFS fitrace error log file to flash before we shutdown
PCI-FPGA EP found, disabling FPGA interrupts
=====Goes for reload
```

The active controller is assigned unit ID 1. It reloads and synchronizes configuration with unit 2. Unit 2 is assigned the role of standby controller.

```
ICX7850-32Q Router(config)#T=22m3.6: Election, was alone --> active, ID=1, pri=0, 2U(1-2), A=u1,
nbr#=1 1, reason: u2: stk-po-chg, ,
T=22m6.0: Election, was active, no change, ID=1, pri=0, 2U(1-2), A=u1, nbr#=1 1, reason: u1: stk-po-
chg, ,
T=22m9.1: reset unit 2: u2 bootup-id=1
Debug: Dec 13 23:21:27
Config changed due to add/del units. Do write mem if you want to keep it
Debug: Dec 13 23:21:30 T=22m14.1: Unit 1 loses all neighbors.
T=22m14.2: Active U1 deletes U2 and its config because it is learned.
T=27m21.6: Election, was active, no change, ID=1, pri=0, 2U(1-2), A=u1, nbr#=1 1, reason: u1: port-
up, ,
Debug: Dec 13 23:26:38 Detect stack unit 2 has different ssh rsahost key, will synchronize it
Debug: Dec 13 23:26:38 T=27m22.0: Synchronize webauth files to u2
T:27m23.6: Done hot swap: active controller u1 sets u2 to Ready.
T=27m24.1: Election, was active, no change, ID=1, pri=0, 2U(1-2), A=u1, nbr#=1 1, reason: u1: stk-po-
chg, ,
Stack unit 2 Power supply 1 is up
Stack unit 2 Power supply 2 is not present
Debug: Dec 13 23:26:45
Config changed due to add/del units. Do write mem if you want to keep it
Debug: Dec 13 23:26:48 T=27m32.0: Synchronize ssh rsa host key to u2
T=28m24.7: Assigned unit 2 to be standby
Debug: Dec 13 23:27:43 T=28m26.7: start running config sync to standby u2
Debug: Dec 13 23:27:43 T=28m27.5: Running config sync to standby u2 is complete
```

After running configuration sync to standby is complete, please save the configuration.

4. Enter the **write memory** command to save the configuration after the two units have synchronized and the standby controller assignment is complete.

```
ICX7850-32Q Router# write memory

There is no startup config file, unable to save legacy config
Flash Memory Write (8192 bytes per dot)
Write startup-config done.

Automatic copy to member units: 2
Flash Memory Write (8192 bytes per dot)
.
Copy Done.
```

Stacking by Device

ICX 7850 stack configuration overview

5. (Optional) Enter the **show stack** command and the **show running-config** command to verify stack formation.

```
ICX7850-32Q Router# show stack
T=31m6.8: alone: standalone, D: dynamic cfg, S: static
ID  Type      Role      Mac Address  Pri State  Comment
1   S ICX7850-32Q  active    d4c1.9e18.3731  0 local  Ready
2   S ICX7850-48FS  standby  d4c1.9e18.8dd9  0 remote  Ready

      active      standby
      +----+      +----+
=3/5| 1 |3/1==2/1| 2 |2/5=
|   +----+      +----+ |
|-----|
Standby u2 - protocols ready, can failover or manually switch over
Role history: N: standalone, A: active, S: standby, M: member
U1: N->A

Current stack management MAC is d4c1.9e18.3731

ICX7850-32Q Router# show running-config
Current configuration:
!
ver 08.0.90_b313T233
!
stack unit 1
  module 1 icx7850-32q-port-management-module
  module 2 icx7800-100g-12port-1200g-module
  module 3 icx7800-100g-8port-800g-module
  stack-trunk 1/3/1 to 1/3/4
  stack-trunk 1/3/5 to 1/3/8
stack unit 2
  module 1 icx7850-48fs-port-management-module
  module 2 icx7800-100g-8port-800g-module
  stack-trunk 2/2/1 to 2/2/4
  stack-trunk 2/2/5 to 2/2/8
stack enable
stack mac d4c1.9e18.3731
!
!
aaa authentication web-server default local
aaa authentication login default local
enable aaa console
!
no telnet server
username super password .....
!
!
hitless-failover enable
!
!
sz registrar
!
!
end
ICX7850-32Q Router#
```

Hitless Stacking

- Hitless stacking overview.....171
- Hitless stacking behavior.....171
- Supported hitless stacking events173
- Non-supported hitless stacking events.....173
- Supported hitless stacking protocols and services.....173
- Hitless stacking configuration notes and feature limitations.....176
- What happens during a hitless stacking switchover or failover.....176
- Standby controller role in hitless stacking.....177
- Support during stack formation, stack merge, and stack split.....178
- Hitless stacking failover.....181
- Hitless stacking switchover.....182
- Displaying information about hitless stacking.....187
- Syslog messages for hitless stacking failover and switchover.....189

Hitless stacking overview

Hitless stacking is supported on FastIron units in a stack. It is a High Availability feature set that ensures little or no loss of data traffic during the following events:

- Active controller failure or role change
- Software failure
- Addition or removal of units in a stack
- Removal or disconnection of the stacking cable between the active controller and the standby controller

During such events, the standby controller takes over the active role, and the system continues to forward traffic seamlessly, as if no failure or topology change has occurred. In software releases that do not support hitless stacking, events such as these could cause most of the units in a stack to reset, affecting data traffic.

FastIron stackable units support the following hitless stacking features:

Hitless stacking switchover - A manually-controlled (CLI-driven) or automatic switchover of the active controller and standby controller without reloading the stack and without any packet loss to the services and protocols that are supported by hitless stacking. A switchover is activated by the CLI command **stack switch-over** command. A switchover may also be activated by the **priority** command, depending on the configured priority value.

Hitless stacking failover - An automatic, forced switchover of the active controller and standby controller because of a failure or abnormal termination of the active controller. During a failover, the active controller abruptly leaves the stack, and the standby controller immediately assumes the active role. As with a switchover, a failover occurs without the stack being reloaded. Unlike a switchover, a failover generally occurs without warning and is likely to result in packet loss for up to a few seconds (packets traversing the stacking link may be lost).

Hitless stacking failover is enabled by default beginning with FastIron release 08.0.20.

Hitless stacking behavior

Hitless stacking is enabled by default for FastIron release 08.0.20 and later releases. In previous releases, the **hitless-failover** command must be set to **enable** in the configuration.

Hitless Stacking

Hitless stacking behavior

If you install a FastIron 08.0.20 or later image on a new system with no previous configuration, the **hitless-failover** command is enabled by default.

If you upgrade to FastIron release 08.0.20 or later from a previous version that has **hitless-failover** enabled, hitless-failover is retained as the default.

If you upgrade to FastIron release 08.0.20 or later on a system with an earlier release that does not have **hitless-failover** enabled in its configuration, the previous configuration is retained.

Hitless stacking can be disabled using the **no hitless-failover enable** command. When hitless failover is disabled, the following limitations are in effect:

- If a failover occurs, every unit in the stack reloads.
- Manual switchover is not allowed. If the **stack switch-over** command is entered, the following message appears on the console:

```
Switch-over is not allowed. Reason: hitless-failover not configured.
```

- Internal switchover resulting from a priority change is blocked until the entire stack is reloaded or hitless stacking is enabled. A priority change triggers an election, but the newly elected winner does not immediately assume its role.
- During a stack merge, the active controller with the highest priority wins the election and reloads every unit of the losing stack.

NOTE

Synchronization between the active controller, standby controller, and stack members occurs whether or not hitless stacking is enabled.

If hitless stacking has been disabled, enable hitless stacking failover as described in "Enabling hitless stacking failover." As soon as hitless stacking is enabled, the following behavior takes effect immediately:

- If a failover occurs, the stack does not reload.
- Manual switchover (CLI command **stack switch-over**) is allowed.
- If a priority change occurred while hitless stacking was disabled and the configured priority value requires a switchover, the system starts a 60-second timer before performing a switchover. After the switchover, the highest priority standby controller becomes the active controller.
- During a stack merge, the active controller with the larger number of units wins the election and reloads every unit of the losing stack.
- If two stacks have the same number of units, the active controller election criteria are based, in order, on priority, system up time, ID, and finally the MAC address.
- If two stacks have the same number of units and the same priority, then the stack with the longest system up time (by 30 seconds or more) wins the election. Otherwise, the smallest ID is compared next, followed by MAC address. If the losing active controller has the highest priority, it becomes the standby controller after reloading and relearning the protocols. It becomes the active controller after an internal switchover.

NOTE

If the active controllers of two merging stacks have different hitless stacking settings (for example, hitless stacking is enabled in one stack and disabled in the other), the winning controller retains its hitless stacking setting and runtime configuration for the merged stack.

You can use the **show stack** command to check whether hitless stacking is enabled.

- If **hitless-failover enable** is configured, the following is displayed:

```
Standby u2 - protocols ready, can failover or manually switch over
```

- If **hitless-failover enable** is not configured, the following is displayed:

```
Standby u2 - No hitless failover. Reason: hitless-failover not configured
```

NOTE

Whether or not hitless-failover is enabled, if the entire stack reloads, and the active controller does not come up, the bootup standby takes over in four minutes or longer, depending on the size of the startup-config file, to allow the active controller sufficient time to process a very large startup-config file during bootup. The bootup standby takes over by reloading every unit including itself. A bootup standby is the device that was the standby controller before the reload. It may not be the current standby controller.

Supported hitless stacking events

The following events are supported by hitless stacking:

- Failover
- Switchover
- Priority change
- Role change

Non-supported hitless stacking events

The following events are not supported by hitless stacking. These events require a software reload, affecting data traffic.

- Unit ID change - When a stack is formed or when a unit is renumbered using stack interactive-setup.
- Stack merge - When the old active controller comes back up, it reboots. If it has fewer members than the present active controller, it loses the election, regardless of its priority. If it has a higher priority, it becomes the standby controller after the reboot and is synchronized with the active controller. Next, a switchover occurs, and it again becomes the active controller.
- Stack upgrade - Software cannot be upgraded on stack units without impact on traffic, unless the upgrade is performed through ISSU. Refer to the *Ruckus FastIron Software Upgrade Guide* for more information.

Supported hitless stacking protocols and services

The following table highlights the impact of a hitless switchover or failover on the major functions of the system.

Hitless Stacking

Supported hitless stacking protocols and services

NOTE

Services and protocols that are not listed in the following table encounter disruptions, but resume normal operation once the new active controller is back up and running.

TABLE 26 Supported hitless stacking protocols and services

Traffic type	Supported protocols and services	Impact
Layer 2 switched traffic, including unicast and multicast + System-level + Layer 4	<ul style="list-style-type: none"> • 802.1p and 802.1Q • 802.3ad - LACP • 802.3af - PoE • 802.3at - PoE+ • DSCP honoring and Diffserv • Dual-mode VLAN • IGMP v1, v2, and v3 snooping • Layer 2 switching (VLAN and 802.1Q-in-Q) • MLD v1 and v2 snooping • MRP • Multiple Spanning Tree (MSTP) • Physical port/link state • PIM SM snooping • Port mirroring and monitoring • Port trunking • Rapid Spanning Tree (RSTP) • Spanning Tree (STP) • ToS-based QoS • Policy Based Routing • Traffic policies • UDLD • VSRP 	<p>Layer 2 switched traffic is not affected during a hitless stacking event. All existing switched traffic flows continue without interruption.</p> <p>New switched flows are not learned by the switch during the switchover process and are flooded to the VLAN members in hardware. After the new active controller becomes operational, new switched flows are learned and forwarded accordingly. The Layer 2 control protocol states are not interrupted during the switchover process.</p>
Layer 3 IPv4 routed traffic (unicast)	<ul style="list-style-type: none"> • IPv4 unicast forwarding • Static routes • OSPF v2 • OSPF v2 with ECMP • VRRP • VRRP-E • BGP4+ 	<p>Layer 3 routed traffic for supported protocols is not affected during a hitless stacking event.</p> <p>Other Layer 3 protocols that are not supported will be interrupted during the switchover or failover.</p> <p>If BGP4+ graceful restart or OSPF graceful restart is enabled, traffic converges to normalcy after the new active module becomes operational. For details about OSPF graceful restart and BGP4+ graceful restart, refer to the <i>Ruckus FastIron Layer 3 Routing Configuration Guide</i>.</p>
Layer 3 IPv6 routed traffic (unicast and multicast)	<ul style="list-style-type: none"> • IPv6 Unicast forwarding • OSPF V3 • VRRP V3 • VRRP-E V3 • BGP 4+ 	<p>OSPF (V2 or V3) has graceful restart enabled by default. Existing traffic flows will not be disturbed. To achieve hitless functionality, "non-stop routing" must be enabled under OSPF.</p>

TABLE 26 Supported hitless stacking protocols and services (continued)

Traffic type	Supported protocols and services	Impact
Management traffic	N/A	All existing management sessions (SNMP, Telnet, HTTP, HTTPS, FTP, TFTP, SSH, and so on) are interrupted during the switchover process. Sessions are terminated and can be re-established after the new active controller takes over.
Security	<ul style="list-style-type: none"> • ACLs • Dos attack prevention (TCP syn/ICMP) • DHCP snooping • Dynamic ARP inspection • IP source guard • MAC filter • MAC port security 	<p>Supported security protocols and services are not affected during a switchover or failover, with the following exceptions:</p> <ul style="list-style-type: none"> • IPsec, when enabled on an ICX 7450 stack, does not support hitless stacking because IPsec sessions must be re-established by device firmware. Stacking split, merge, and member reload follow normal stacking behaviors. • Media Access Control Security (MACsec), 802.1ae, when configured on an ICX 7450 stack, does not support hitless stacking because MACsec sessions must be re-established by device firmware. • 802.1X is affected if re-authentication does not occur in a specific time window. • MAC authentication is affected if re-authentication does not occur in a variable-length time window. • In some cases, a few IP source guard packets may be permitted or dropped. • If 802.1X and MAC authentication are enabled together on the same port, both will be affected during a switchover or failover. Hitless stacking support for these features applies to ports with 802.1X only or multi-device port authentication only. • For MAC port security, secure MAC addresses are synchronized between the active and standby controllers, so they are hitless. However, denied MAC addresses are lost during a switchover or failover but may be relearned if traffic is present. <p>Configured ACLs will operate in a hitless manner. That is, the system will continue to permit and deny traffic during the switchover or failover process. However, dynamic ACLs are not supported for hitless switchover and failover.</p> <p>After a switchover or failover, the new active controller will re-authenticate 802.1X or MAC authentication sessions that were being forwarded in hardware.</p>
Other services to management	<ul style="list-style-type: none"> • AAA • DHCP • sFlow • SNMP v1, v2, and v3 • SNMP traps • SNTP • Traceroute 	<p>Supported protocols and services are not affected during a switchover or failover.</p> <p>DNS lookups will continue after a switchover or failover. This information is not synchronized.</p> <p>Ping traffic will be minimally affected.</p>

Hitless stacking configuration notes and feature limitations

- Layer 3 multicast traffic is supported by hitless stacking.
- After a switchover or failover, the syslog may contain invalid (non-existent) port numbers in messages such as "Interface *portnum* state up." This is because some messages from the old active controller remain in the syslog after a switchover or failover.
- Failover for devices connected to the management port is not supported. For example, if during a failover, an end station is connected to the stack through the management port of the active controller, the connection is shut down. After the failover, the management port on the new active controller will work.
- The following describes hitless stacking limitations with software-based licensing for BGP:
 - To enable BGP on a stack unit, you should have an appropriate BGP license installed on all the stack units.
 - If the active controller has a BGP license but any other unit in the stack does not have one, you cannot enable BGP on the stack unit.
 - If the active controller is not running BGP, a stack unit is operational regardless of whether the active controller or stack units have a BGP license.
 - If the active controller is running BGP and a unit without a BGP license joins the stack, the unit is put into a non-operational state. However, if the user installs a valid BGP license to a non-operational unit, the unit immediately becomes operational. If the user disables BGP instead, the active controller returns the non-operational units to operation.

What happens during a hitless stacking switchover or failover

This section describes the internal events that enable a controlled or forced switchover to take place in a hitless manner as well as the events that occur during the switchover.

Real-time synchronization among all units in a stack

Hitless stacking requires the active controller, standby controller, and stack members to be fully synchronized at all times. This is accomplished by baseline and dynamic synchronization of all units in a stack.

When a stack is first booted and becomes operational, baseline synchronization occurs across all of the units in the stack. The active controller copies the current state of its CPU to all units of the stack, including the standby controller. The information received from the active controller is programmed locally in the hardware on all units. The information includes:

- Startup and runtime configuration (CLI) - These files are copied to the standby controller only.
- Layer 2 protocols - Layer 2 protocols such as STP, RSTP, MRP, and VSRP run concurrently on both the active controller and standby controller.
- Hardware Abstraction Layer (HAL) - This includes the prefix-based routing table, next hop information for outgoing interfaces, and tunnel information.
- Layer 3 IP forwarding information - This includes the routing table, IP cache table, and ARP table as well as static and connected routes. Layer 3 routing protocols are not copied to any of the units in the stack but remain in standby state on the standby controller until a switchover occurs. Peer adjacency is restored after a switchover. If BGP4 or OSPF graceful restart is enabled during a switchover, the standby controller (new active controller) initiates a graceful restart,

and a new set of routes is relearned. The new set of routes will be the same as the old routes, unless the network has changed.

- OSPFv2 and OSPFv3 non-stop routing support - For more information, refer to the *Ruckus FastIron Layer 3 Routing Configuration Guide*.

When control protocols are synchronized and protocol synchronization timers have expired, the standby controller is placed in hot-standby mode, ready to take over as the active controller. If a switchover occurs, the standby controller takes over without interrupting data traffic.

After baseline synchronization, any new events that occur on the active controller are dynamically synchronized on the standby controller. Such events include:

- CLI, HTTP, and SNMP configurations
- Link events
- Interrupts
- Layer 2 and Layer 3 forwarding table updates
- Dynamic user authentication updates such as 802.1X or multi-device port authentication

After a switchover, the new active controller receives updates from the stack members and sends verification information to the stack members to ensure that they are synchronized.

NOTE

The events described previously occur internally and do not create or affect the external network topology.

Standby controller role in hitless stacking

In software releases that do not support hitless stacking, the standby controller functions as a dummy device, meaning it provides limited access to CLI commands such as **show**, **stack**, and a few **debug** commands. The active controller can access the full range of the CLI. The standby controller synchronizes its configuration with the active controller at each reset.

With the introduction of hitless stacking, the standby controller shadows the active controller. The role or behavior of the standby controller with hitless stacking is as follows:

- The local console on the standby controller still accepts only **show**, **stack**, and a few **debug** commands.
- The runtime configuration on the standby controller is synchronized with the active controller whenever there is a configuration change.
- Protocols are configured in the runtime configuration, but no protocol packets are sent out on the standby controller.
- The state of every unit is known, including the state of the active controller. The **show** commands display current information such as STP or port states.
- When a failover occurs, the standby controller uses its current runtime configuration. The configuration could be different from the active controller if the last configuration transmission was lost.
- After a failover, the new active controller (the old standby controller) programs all other units in hardware, based on its runtime configuration.

Standby controller election

Candidates for standby controller must meet the following criteria:

- The unit is operational, and the image and module configuration match those of the active controller.

Hitless Stacking

Support during stack formation, stack merge, and stack split

- The runtime configuration matches that of the active controller.

If more than one unit in the stack meets these criteria, the standby controller is chosen according to the following criteria, in the order shown:

- Priority - The unit with the highest priority value.
- Current standby - The unit that is currently the standby controller.
- Bootstrap master - The unit that was the active controller before the stack was reloaded.
- Bootstrap standby - The unit that was the standby controller before the stack was reloaded.

Once the standby controller is identified, the following internal events take place.

1. The standby controller is assigned by the active controller 30 to 60 seconds after election (60 seconds if the active controller boots up in less than 120 seconds).
2. The standby controller receives and processes the runtime configuration sent by the active controller.
3. The standby controller learns the protocols within 70 seconds.

When the standby controller is fully synchronized, the system is ready for a switchover or failover.

Runtime configuration mismatch

In some cases, such as a runtime configuration mismatch between the active controller and candidate standby controller, the standby controller cannot be assigned by the active controller unless the candidate standby controller is reloaded.

As shown in the following example, the **show stack** command output indicates whether there is a runtime configuration mismatch.

```
device# show stack
alone: standalone, D: dynamic config, S: static config
ID  Type      Role  MAC Address  Pri  State  Comment
1  S  ICX7750-48XGC  active 0000.0001.0000  30  local  Ready
2  d  ICX7750-48XGC  member 0000.0002.0000  20  remote Ready, standby if reload
      active
      +----+      +----+
      -2/1| 2 |2/2--2/1| 1 |2/2-
      +----+      +----+
Note: There is no standby. Reason: u2: diff runtime config
Current stack management MAC is 0000.0001.0000
Note: no "stack mac" config. My MAC will change after failover.
```

Support during stack formation, stack merge, and stack split

The following figure illustrates hitless stacking support during stack formation. Operational stages 1 and 2 are also shown.

FIGURE 51 Hitless stacking support during stack formation

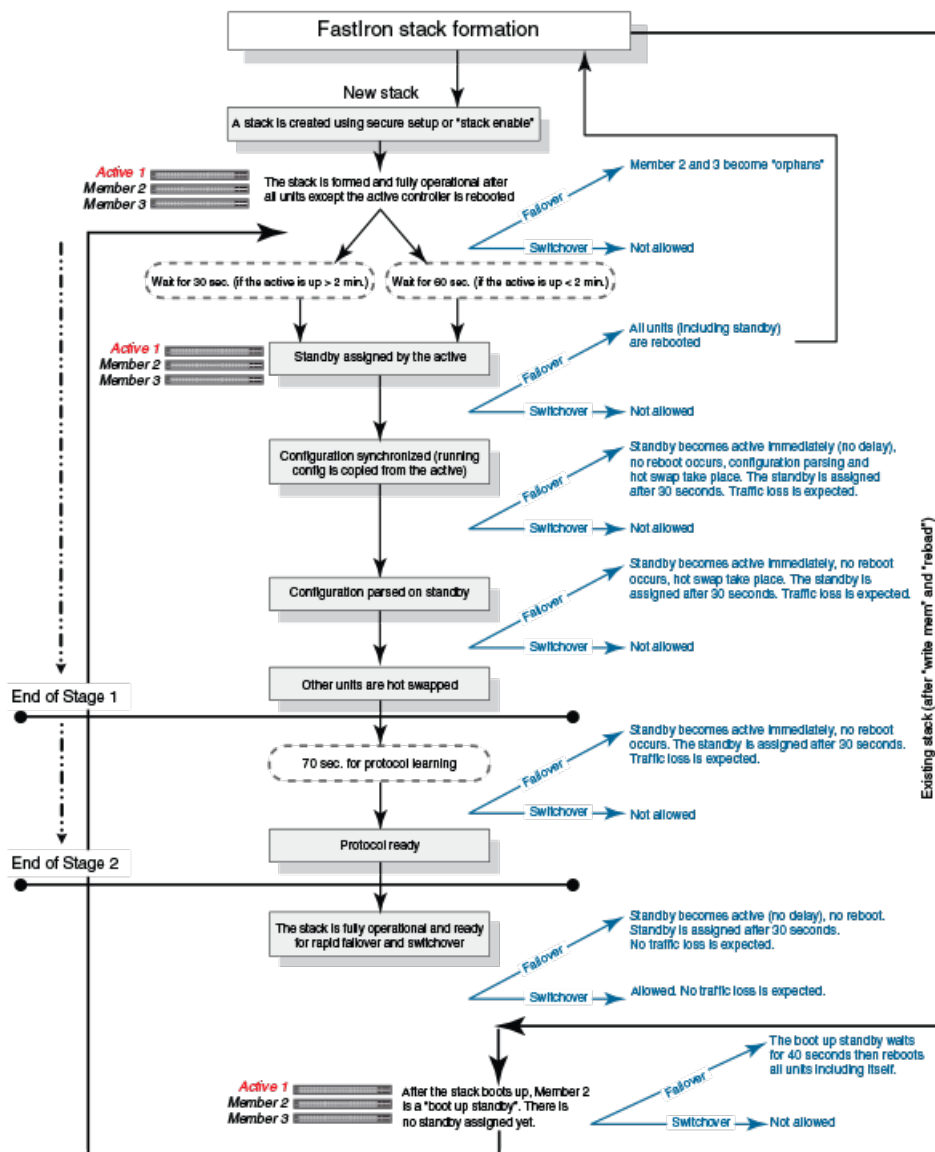

The following figure illustrates hitless stacking support during a stack merge.

Hitless Stacking

Support during stack formation, stack merge, and stack split

FIGURE 52 Hitless stacking support during a stack merge

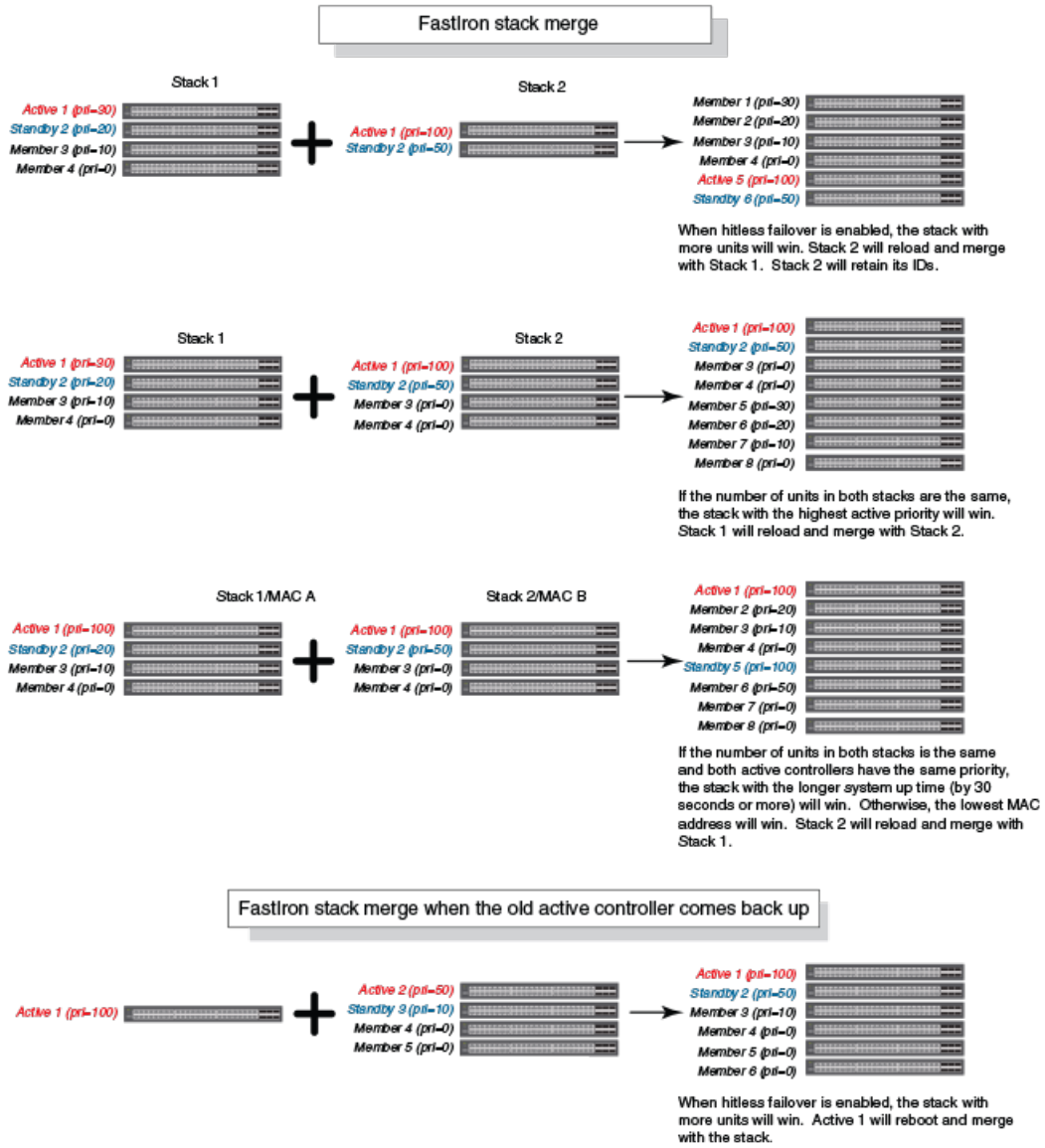

The following figure illustrates hitless stacking support in a stack split.

FIGURE 53 Hitless stacking support in a stack split

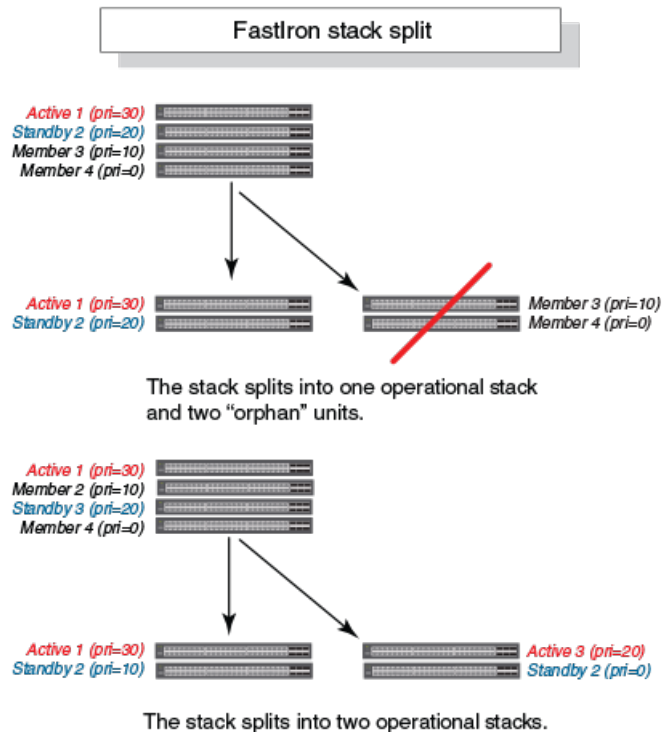

Hitless stacking failover

Hitless stacking failover provides automatic failover from the active controller to the standby controller without resetting any of the units in the stack and with little or no packet loss to hitless stacking-supported services and protocols.

For a description of the events that occur during a hitless failover, refer to [What happens during a hitless stacking switchover or failover](#) on page 176.

For a description of this feature's impact on major system functions, refer to [Supported hitless stacking protocols and services](#) on page 173.

For an example of hitless failover operation, refer to [Hitless stacking failover example](#) on page 182.

For feature limitations and configuration notes, refer to [Hitless stacking configuration notes and feature limitations](#) on page 176.

Enabling hitless stacking failover

NOTE

Hitless stacking failover is enabled by default in FastIron release 08.0.20 and later releases.

To enable hitless stacking failover, enter the following command at the global CONFIG level of the CLI:

```
device# configure terminal
device(config)# hitless-failover enable
```

The command takes effect immediately. Hitless switchover is allowed, and in the event of a failover, the standby controller takes over the active role without reloading the stack.

NOTE

Use the **no** form of the **hitless-failover enable** command to disable hitless stacking failover once it has been enabled.

Hitless stacking failover example

FIGURE 54 Hitless stacking failover when the active controller fails

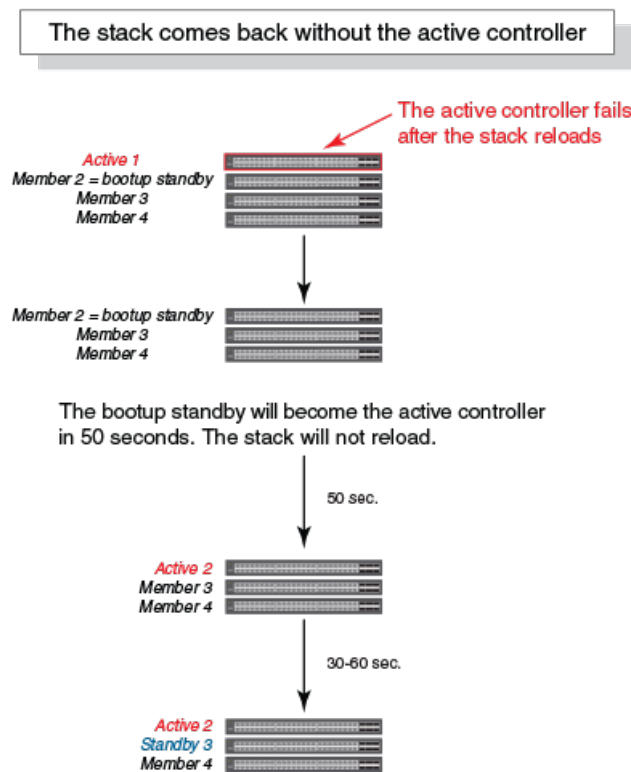

Hitless stacking switchover

Hitless stacking switchover is a manually-controlled (CLI-driven) or automatic switchover of the active controller and standby controller without reloading the stack and without any packet loss to the services and protocols that are supported by hitless stacking. A switchover is activated by the **stack switch-over** CLI command. A switchover may also be activated by the **priority** command, depending on the configured priority value.

By default, hitless switchover is allowed on systems with FastIron release 08.0.20 or later installed, as long as hitless failover is configured, and the priority of the two controllers is the same. Hitless switchover behavior is described in [Hitless stacking behavior](#) on page 171.

Hitless switchover can be used by a system administrator to perform maintenance on a controller that has been functioning as the active controller.

For a description of the events that occur during a hitless stacking switchover, refer to [What happens during a hitless stacking switchover or failover](#) on page 176.

For a description of how hitless stacking switchover affects major system functions, refer to [Supported hitless stacking protocols and services](#) on page 173.

For examples of hitless stacking switchover operation, refer to [Hitless stacking switchover examples](#) on page 183.

Executing a hitless stacking switchover

The following must be in effect before a hitless switchover (to the standby controller) is allowed:

- Hitless stacking is enabled.
- The stack has a standby controller.
- The standby controller has learned the protocols.
- The standby controller has the same priority as the active controller.
- More than 120 seconds have passed since the previous switchover or failover.

You can use the **show stack** command to check these criteria.

To perform a switchover, enter the following command.

```
device# stack switch-over
Standby unit 8 will become active controller, and unit 1 will become standby
Are you sure? (enter 'y' or 'n'): y
Unit 1 is no longer the active controller
```

Hitless stacking switchover examples

The following examples illustrate hitless stacking failover and switchover operation during a CLI-driven switchover or priority change.

The following figure illustrates a hitless stacking switchover triggered by the **stack switch-over** command.

FIGURE 55 Manual switchover

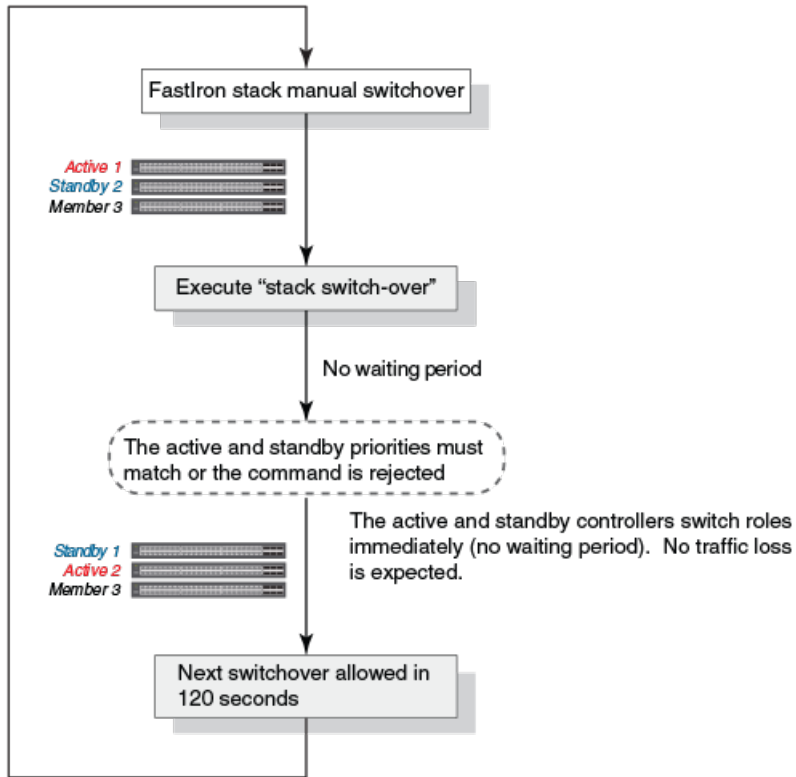

The following figure illustrates a hitless stacking switchover when the active controller goes down and then comes back up. The stack in this example has user-configured priorities.

FIGURE 56 Hitless stacking switchover when the active controller comes back up

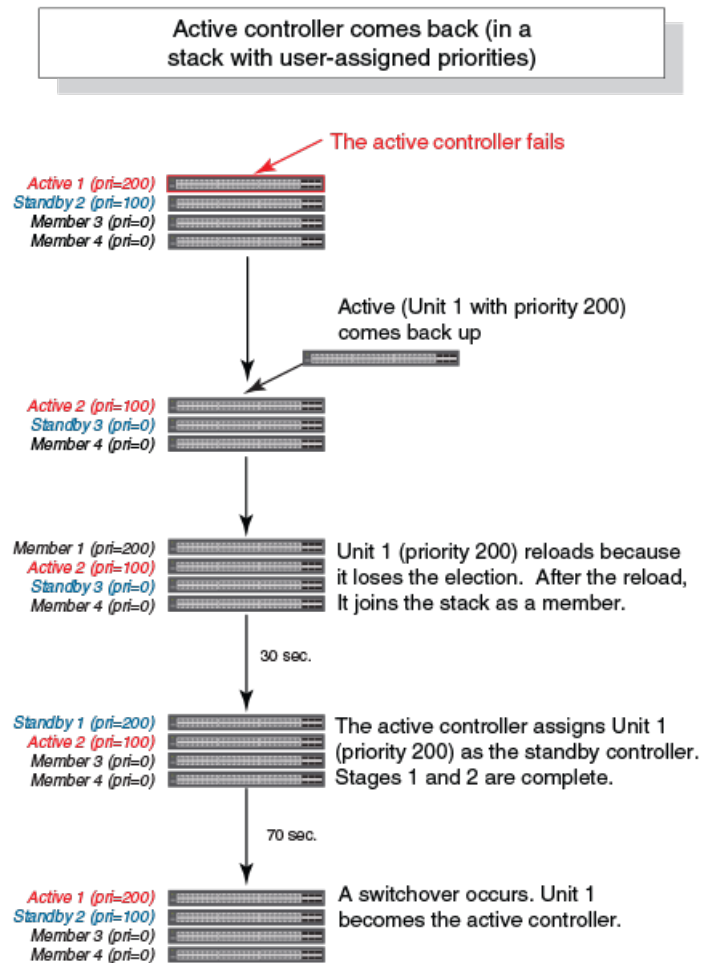

The following figure illustrates a hitless stacking switchover after the network administrator increases the priority value of the standby controller.

FIGURE 57 Scenario 1 - Hitless stacking switchover after a priority change

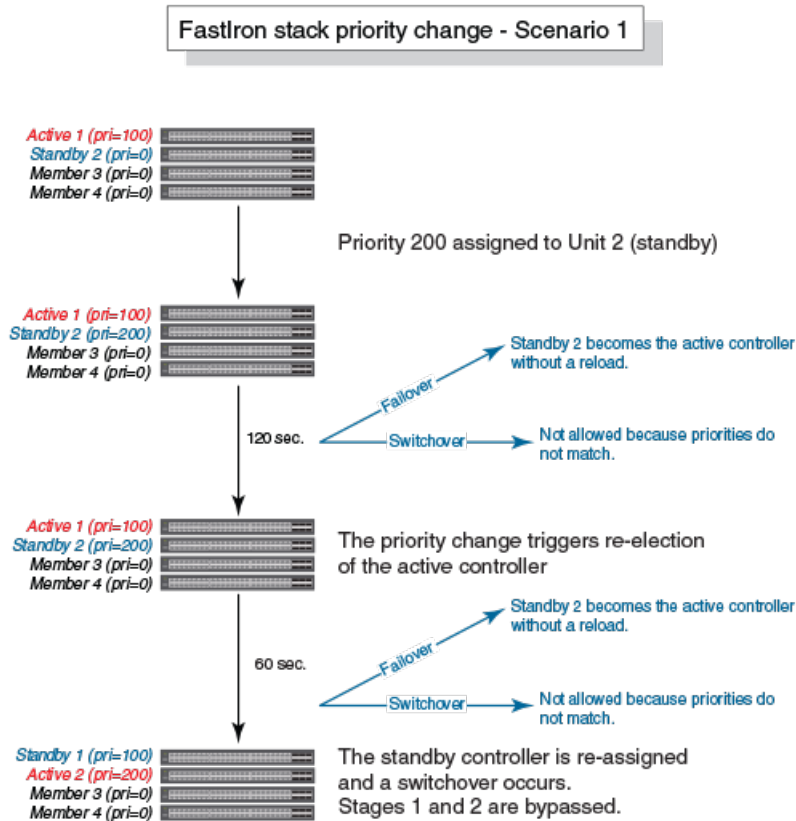

The following figure illustrates a hitless stacking switchover after the network administrator increases the priority value of one of the stack members.

FIGURE 58 Scenario 2 - Hitless stacking switchover after a priority change

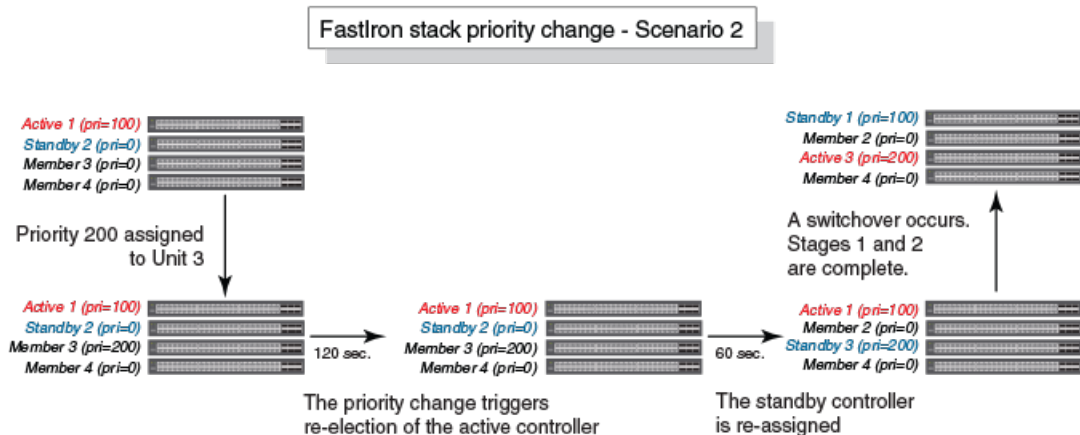

The following figure illustrates a hitless stacking switchover after the network administrator increases the priority value for two of the stack members.

FIGURE 59 Scenario 3 - Hitless stacking switchover after a priority change

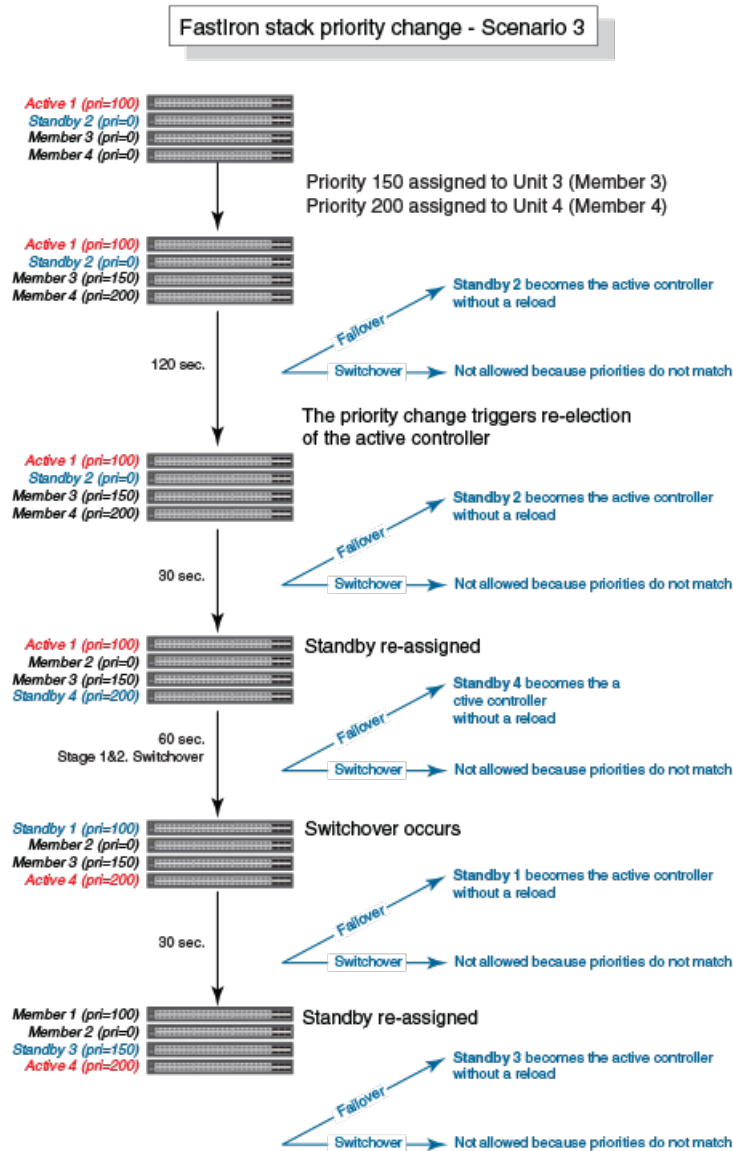

Displaying information about hitless stacking

Use the **show stack** command to view information pertinent to a hitless stacking switchover or failover. The command output illustrates the active controller and standby controller, as well as the readiness of the standby controller to take over the role of active controller, if needed.

```
ICX7750-26Q Router# show stack
T=1lh25m50.2: alone: standalone, D: dynamic cfg, S: static
ID  Type      Role      Mac Address      Pri State  Comment
1   S ICX7750-26QXG active  748e.f8f9.6300  255 local  Ready
2   S ICX7750-26QXG standby cc4e.2438.7280  240 remote Ready
3   S ICX7750-26QXG member  cc4e.2438.7500  0 remote Ready

active          standby
```

Hitless Stacking

Displaying information about hitless stacking

```
      +----+      +----+      +----+
-2/1| 1 |2/4--2/1| 3 |2/4--2/1| 2 |2/4-
|   +----+      +----+      +----+ |
|   |-----|
Standby u2 - protocols ready, can failover
Current stack management MAC is 748e.f8f9.6300
```

Displaying information about stack failover

Use the **show stack failover** command to view information about rapid failover. The **show stack failover** command provides information on the current standby controller and its status as shown in the following example.

```
device# show stack failover
Current standby is unit 2. state=ready
Standby u2 - protocols ready, can failover
```

Displaying hitless stacking status

The **show stack** command indicates whether hitless stacking is enabled. The following example shows that hitless stacking is disabled.

```
ICX7750-26Q Router(config-unit-1)# show stack
T=17m47.9: alone: standalone, D: dynamic cfg, S: static
ID  Type           Role      Mac Address   Pri State  Comment
1  S ICX7750-26QXG active   748e.f8f9.6300 0 local  Ready
2  D ICX7750-26QXG member  cc4e.2438.7280 0 remote Ready
3  D ICX7750-26QXG standby  cc4e.2438.7500 0 remote Ready

      active       standby
      +----+      +----+      +----+
=2/1| 1 |2/4==2/1| 3 |2/4--2/1| 2 |2/4=
|   +----+      +----+      +----+ |
|   |-----|
Standby u3 - No hitless failover. Reason: hitless-failover not configured
```

Displaying pending device roles

When hitless stacking is disabled, a priority change triggers an election, but the newly-elected winner does not assume its role until the entire stack is reloaded or hitless stacking is enabled. You can use the **show stack** command to view pending device roles. The “Role” column displays the current role for each unit. The “Comment” column displays the role that will take effect after a reload or when hitless stacking is enabled.

```
ICX7750-26Q Router(config-unit-1)# show stack
T=17m47.9: alone: standalone, D: dynamic cfg, S: static
ID  Type           Role      Mac Address   Pri State  Comment
1  S ICX7750-26QXG active   748e.f8f9.6300 0 local  Ready, member if reloaded
2  D ICX7750-26QXG member  cc4e.2438.7280 128 remote Ready, standby if reloaded
3  D ICX7750-26QXG standby  cc4e.2438.7500 200 remote Ready, active if reloaded
```

Displaying information about link synchronization status

Use the **show stack link-sync status** command to view the status of the link synchronization.

```
ICX7750-26Q Router# show stack link-sync status
STACKING_LINK_GLOBAL_CTRL messages sent: 0, received: 0
STACKING_LINK_INDIVIDUAL_CTRL messages sent: 0, received: 0
STACKING_LINK_STATUS messages sent: 235, received: 225
```

```

STACKING_POE_SCTRL messages sent: 0, received: 0
STACKING_POE_STATUS messages sent: 0, received: 0
global_ctrl_dest: 0
individual_ctrl_dest: 0
status_dest: 2

```

Syslog messages for hitless stacking failover and switchover

Syslog messages are generated for the following events:

- Switchover
- Failover
- Standby controller assignment

The following table lists the supported syslog messages for hitless stacking failover and switchover.

TABLE 27 Supported syslog messages for hitless stacking failover and switchover

Message level	Message	Explanation
Informational	Stack: Stack unit <i>unit_number</i> has been assigned as STANDBY unit of the stack system	Indicates that the unit has been assigned as the standby controller.
Informational	Stack: Stack is operational due to SWITCH-OVER	Indicates that a switchover has occurred.
Informational	Stack: Stack is operational due to FAIL-OVER	Indicates that a failover has occurred.

To view the system log or the traps logged on an SNMP trap receiver, enter the **show log** command at any level of the CLI. The following sample output shows what the log may look like after a switchover or assignment of the standby controller.

```

device# show log
Syslog logging: enabled (0 messages dropped, 1 flushes, 0 overruns)
  Buffer logging: level ACDMEINW, 8 messages logged
  level code: A=alert C=critical D=debugging M=emergency E=error
               I=informational N=notification W=warningDynamic Log Buffer (50 lines):
0d00h05m34s:I:System: Interface ethernet mgmt1, state up
0d00h05m33s:I:Stack: Stack unit 8 has been assigned as STANDBY unit of the stack system
0d00h05m33s:I:Stack: Stack is operational due to SWITCH-OVER
0d00h05m32s:I:Stack: Stack unit 1 has been elected as ACTIVE unit of the stack system
0d00h05m29s:W:System:Stack unit 2 Fan speed changed automatically to 2
0d00h05m25s:W:System:Stack unit 5 Fan speed changed automatically to 2
0d00h05m00s:I:System: Interface ethernet mgmt1, state down
0d00h05m00s:I:Security: Telnet server enabled by from session

```

The following sample output shows what the log may look like after a failover of the active controller.

```

device# show log
Syslog logging: enabled (0 messages dropped, 0 flushes, 0 overruns)
  Buffer logging: level ACDMEINW, 12 messages logged
  level code: A=alert C=critical D=debugging M=emergency E=error
               I=informational N=notification W=warning

Dynamic Log Buffer (50 lines):
0d00h04m41s:I:Stack: Stack unit 3 has been assigned as STANDBY unit of the stack system
0d00h04m12s:I:System: Interface ethernet mgmt1, state up
0d00h04m10s:I:System: Interface ethernet mgmt1, state down
0d00h04m10s:I:System: Interface ethernet mgmt1, state up
0d00h04m09s:I:STP: VLAN 1 Bridge is RootBridge: 800000e052010000 (MgmtPriChg)
0d00h04m09s:I:System: Management MAC address changed to 0000.0001.0000
0d00h04m09s:I:Stack: Stack is operational due to FAIL-OVER
0d00h04m08s:I:Stack: Stack unit 1 has been elected as ACTIVE unit of the stack system

```

Hitless Stacking

Syslog messages for hitless stacking failover and switchover

```
0d00h04m08s:I:STP: VLAN 1 Port 8/1/1 STP State -> DISABLED (PortDown)
0d00h04m08s:I:STP: VLAN 1 Port 8/1/1 STP State -> FORWARDING (PortDown)
0d00h04m08s:I:System: Interface ethernet 1/2/2, state down
0d00h04m06s:I:System: Interface ethernet 8/2/2, state down
```

Stack Management

- Managing a stack through one IP address..... 191
- Enabling or disabling stacking mode..... 191
- Controlling the stack through the CLI..... 192
- Stack unit identification 193
- Naming a stack unit..... 194
- Stack management MAC address..... 195
- Stack device roles and elections..... 197
- Stack unit priority..... 200
- Stack software images..... 202
- Stack mismatches..... 202
- Configuring stacking trunks in a live environment..... 207
- Configuring stacking ports in a live environment..... 209
- Adding, removing, or replacing units in a stack..... 210
- Reloading a stack unit..... 215
- Managing stack partitioning..... 216
- Merging stacks..... 216
- Unconfiguring a stack..... 217
- Syslog, SNMP, and traps for stack units..... 218
- Displaying stack information..... 219
- MIB support for ICX stack configurations..... 235

Managing a stack through one IP address

A Ruckus stack can be managed through a single IP address. You can manage the stack using this IP address even if you remove the active controller or any member from the stack. You can also connect to the active controller through Telnet or SSH using this address. All management functions, such as SNMP, use this IP address to acquire MIB information and other management data.

Enabling or disabling stacking mode

When a unit is stack-enabled or joins a stack either actively or passively, it reserves priority queue 7 for stacking traffic control, assigns buffers for the stacking ports, and configures the first two 10-Gbps ports as stacking ports.

NOTE

Designated stacking ports cannot contain any configuration information, such as VLAN membership. If configuration information exists, **stack enable** will fail. You must remove all configuration information from the port and re-issue the **stack enable** command.

To enable stacking mode on a new unit before you add it to the stack, enter the following command.

```
device# configure terminal
device(config)# stack enable
Enable stacking. This unit actively participates in stacking
```

To see the configuration of the stack at any time, enter the **show running-config** command. Refer to [Displaying running configuration information](#) on page 220 for details.

Disabling stacking mode

To remove stacking capability, enter the **no stack enable** command. This prevents the unit from actively sending out probe messages; however, the unit could still be called to join a stack by an active controller. To prevent this, enter the **stack disable** command in device configuration mode.

The **stack disable** command prevents a unit from sending or listening for any stacking probe messages. In this mode, the unit cannot be forced to join a stack.

```
device# configure terminal
device(config)# stack disable
```

To restore the capability of the device to send and receive stacking probe messages, enter the **no stack disable** command in device configuration mode.

Controlling the stack through the CLI

A Ruckus stack can be configured and managed using the command line interface (CLI). You can access the stack and the command CLI in two ways:

- Through a direct serial connection to the console port
- Through a local or remote Telnet session using the stack IP address

You can initiate a local Telnet or SNMP connection by attaching a cable to a port and specifying the assigned management station IP address.

The stacking commands in the CLI are organized into the following levels:

- **Global** - Commands issued in global mode are applied to the entire stack.
- **Configuration mode** - In this mode, you can make configuration changes to the entire stack. To save changes across reloads, you must save them to the active controller startup-config file. The configuration mode contains sub-levels for individual units and ports, VLANs, routing protocols, and other configuration areas.
- **Stack unit configuration mode** - Commands issued in this mode apply to the specified stack unit. Configuration information resides in the active controller.

NOTE

By default, any user who can open a serial or Telnet connection to the stack can access all of these CLI levels. To secure access, you can enable passwords or local user accounts, or you can configure the active controller to use a RADIUS or TACACS/TACACS+ server for authentication. Refer to the *Ruckus FastIron Security Configuration Guide* for more information.

Logging in through the console port

When a device becomes a stack member, it establishes a remote connection to a virtual console port on the active controller. Input and output are relayed between the physical console port on the stack member and the virtual console port on the active controller. Because each stack member connects to an independent virtual console port on the active controller, the console ports on multiple stack units may be used simultaneously.

When a stack unit establishes communication with the active controller, it also establishes a remote console session to the active controller. In a normally functioning stack, a console cable may be connected to any of the stack units and provide access to the same commands on the active controller.

To establish a remote console session on a stack unit, enter the **rconsole** command followed by the stack unit ID as shown in the following example.

```
device# rconsole 1
```

You can terminate a session between stack members in any of these ways:

- Enter the **logout** command at any level.
- Enter the **exit** command from the User EXEC level.

NOTE

For **rconsole** connections from stack units to the active controller, the escape sequence and other methods of terminating the session are not available.

NOTE

Error messages that are generated during a reload of the active controller do not appear on **rconsole** connections from stack units to the active controller. To see these error messages, you must connect a console cable to the active controller itself.

The following example shows how to establish a remote console session to a stack member and obtain status information. Notice that the **show stack** command on the stack member displays different information from what is shown when the **show stack** command is entered on the active controller.

A remote console session is established with stack unit 2 in the following example.

```
device# rconsole 2
Connecting to unit 2... (Press Ctrl-O X to exit)
rconsole-2@device# show stack
ID   Type   Role   Mac Address   Prio  State   Comment
2   D   ICX7750-48XGF  standby   cc4e.246d.8d800  0   local   Ready
rconsole-2@device# exit
rconsole-2@device> exit
Disconnected. Returning to local session...
```

NOTE

You can also use the **rconsole** command followed by the PE ID from a CB unit to reach a PE unit.

CLI command syntax for stack units

CLI syntax that refers to stack units must contain all of the following parameters:

- *stack-unit* - If the device is operating as a standalone, the stack-unit is 1. Stack unit IDs can be any number from 1 through 12.
- *slotnum* - This refers to a specific group of ports on each device.
- *portnum* - This must be a valid port number.

Stack unit identification

Stack units are identified by numbers 1 through 12. You can display stack unit IDs by entering the **show stack** command.

A new device (one that has not been connected in a stack or that has not been manually assigned a stack unit number) ships with a default number of 1. Once you enable stacking and the unit becomes part of a stack, its default stack unit number changes to the lowest available number in the stack. You can configure the **stack suggested-id** command in a standalone unit before it joins a stack to assign this unit the suggested ID.

Stack units must each have a unique identification number. Every stack member, including any standalone units, retains its stack unit number unless that number is already being used in the stack, or until you manually renumber the unit using stack interactive-setup. For more information about how to renumber stack IDs using stack interactive-setup, refer to [Changing stack unit IDs with stack interactive-setup](#) on page 75.

Naming a stack unit

You can assign names to stack units to help identify them. Stack unit names can be up to 63 characters long. A stack unit name must start with an alpha character and must not contain spaces.

Perform these steps to assign a name to one or more stack members.

1. Enter global configuration mode.

```
device# configure terminal
```

2. Enter the **stack unit** command followed by the number of the stack unit you want to name.

```
device(config)# stack unit 1
```

The device enters stack unit configuration mode.

3. Enter the **unit-name** command followed by the name that you want to represent the unit in configuration output.

```
device(config-unit-1)# unit-name operations
```

The example assigns the name operations to stack unit 1.

4. (Optional) Repeat steps 3 and 4. You can repeat this step as many times as needed.

```
device(config-unit-1)# stack unit 2  
device(config-unit-2)# unit-name engineering
```

The example enters stack unit configuration mode for unit 2 and assigns the name engineering to the unit.

5. When you are finished naming units, enter the **write memory** command in Privileged Exec mode to save the configuration.

```
device(config-unit-2)# end  
device# write memory
```

The following example assigns names to the members of a three-unit stack, based on the building they support.

```
device# configure terminal
device(config)# stack unit 1
device(config-unit-1)# unit-name building1
device(config-unit-1)# stack unit 2
device(config-unit-2)# unit-name building2
device(config-unit-2)# stack unit 3
device(config-unit-3)# unit-name building3
device(config-unit-3)# end
device# write memory

Automatic copy to member units: 2 3
Flash Memory Write (8192 bytes per dot)
.
Copy Done.

device# show running-config
Current configuration:
!
ver 08.0.90
!
stack unit 1
  unit-name building1
  module 1 icx7750-48-qxg-port-management-module
  module 2 icx7750-qsfp-6port-qsfp-240g-module
  module 3 icx7750-6q-6port-qsfp-240g-module
  priority 128
  stack-trunk 1/2/1 to 1/2/3
  stack-port 1/2/4
stack unit 2
  unit-name building2
  module 1 icx7750-20-qxg-port-management-module
  module 2 icx7750-qsfp-6port-qsfp-240g-module
  module 3 icx7750-6q-6port-qsfp-240g-module
  stack-port 2/2/1
  stack-port 2/2/4
stack unit 3
  unit-name building3
  module 1 icx7750-48-qxc-port-management-module
  module 2 icx7750-qsfp-6port-qsfp-240g-module
  module 3 icx7750-6q-6port-qsfp-240g-module
  stack-port 3/2/1
  stack-port 3/2/4
stack enable
stack mac cc4e.246d.9e00
!
ip route 0.0.0.0/0 10.176.131.129
!
hitless-failover enable
!
interface management 1
  ip address 10.176.131.142 255.255.255.128
!
end
```

Stack management MAC address

The stack is identified in the network by a single MAC address, usually the MAC address of the active controller (the default). If a new active controller is elected, the MAC address of the new active controller (by default) becomes the MAC address for the entire stack. However, you can manually configure your stack to use a specified MAC address.

In a stack, the management MAC address is generated by the software and is always the MAC address of the first port of the active controller. This ensures that the management MAC address remains consistent across stack reboots and helps prevent frequent topology changes that result from protocol enable, disable, and configuration changes.

When you are configuring Layer 2 protocols, such as STP, RSTP, and MSTP, on stack units, the management MAC address of the active controller acts as the Bridge ID.

Manually allocating the stack MAC address

When a stack is enabled, “hitless-failover enable” configuration is added, and a default stack MAC address is assigned if none is configured. The address assigned is the MAC address of the unit as shown in the output of the **show stack** command.

The MAC address is a hexadecimal number in the format xxxx.xxxx.xxxx.

If necessary, you can manually configure the stack to use a specific MAC address.

NOTE

The **stack mac** command may be useful for administrative purposes; however, it should be used with caution to prevent duplication of MAC addresses.

To configure a stack MAC address manually, enter the following command in device configuration mode.

```
device# configure terminal
device(config)# stack mac 0000.0000.0011
```

NOTE

Enter the **no** form of the **stack mac** command to revert to the use of the active controllers' MAC address.

The following example shows the stack MAC address being configured manually as confirmed in the **show running-config** command output.

```
ICX7750-26Q Router# configure terminal
ICX7750-26Q Router(config)# stack mac 0000.0000.0011
ICX7750-26Q Router(config)# show running-config
Current configuration:
!
ver 08.0.90
!
stack unit 1
  module 1 icx7750-20-qxg-port-management-module
  module 2 icx7750-qsfp-6port-qsfp-240g-module
  module 3 icx7750-6q-6port-qsfp-240g-module
  priority 255
  stack-port 1/2/1
  stack-port 1/2/4
stack unit 2
  module 1 icx7750-20-qxg-port-management-module
  module 2 icx7750-qsfp-6port-qsfp-240g-module
  module 3 icx7750-6q-6port-qsfp-240g-module
  priority 240
  stack-port 2/2/1
  stack-port 2/2/4
stack enable
stack mac 0000.0000.0011
!
```

To display the stack MAC address (the Management MAC address, the MAC address of the first port of the active controller), enter the **show chassis** command.

```
ICX7450-48F Router# show chassis
The stack unit 1 chassis info:

Power supply 1 (AC - Regular) present, status ok
  Model Number: 23-0000144-02
  Serial Number: 0L8
  Firmware Ver: A
Power supply 1 Fan Air Flow Direction: Front to Back
Power supply 2 not present
```

```
Fan 1 ok, speed (auto): [[1]]<->2
Fan 2 ok, speed (auto): [[1]]<->2

Fan controlled temperature: 62.5 deg-C

Fan speed switching temperature thresholds:
    Speed 1: NM<----->63      deg-C
    Speed 2:      53<-----> 80 deg-C (shutdown)

Fan 1 Air Flow Direction: Front to Back
Fan 2 Air Flow Direction: Front to Back
Slot 1 Current Temperature: 44.5 deg-C (Sensor 1), 62.5 deg-C (Sensor 2), 52.0 deg-C (Sensor 3), 41.5 deg-C
(Sensor 4), 54.5 deg-C (Sensor 5)
Slot 2 Current Temperature: 41.0 deg-C (Sensor 1)
Slot 3 Current Temperature: 45.0 deg-C (Sensor 1)
Slot 4 Current Temperature: 45.0 deg-C (Sensor 1)
    Warning level.....: 70.0 deg-C
    Shutdown level.....: 80.0 deg-C
Boot Prom MAC : cc4e.246d.1378
Management MAC: cc4e.246d.1378
```

NOTE

For field descriptions of the **show chassis** command, refer to [Displaying stack chassis information](#) on page 224.

Stack device roles and elections

There are three distinct roles played by units that are part of a stack:

- Active controller
- Standby controller
- Stack member

Active controller

The active controller contains the saved and running configuration files for each stack member. The configuration files include the system-level settings for the stack and the interface-level settings for each stack member, as well as MIB counters and port status. The standby controller also has a synchronized copy of the active controller startup-config file in case the active controller fails.

When a stack is formed, the console function for each stack member is automatically redirected to the active controller console. The active controller console port handles all stack management functions, as well as ping activity, Telnet sessions, and TFTP image downloads for every stack member. If you connect to the console port on a stack member that is not the active controller, you are automatically directed through the console of the active controller.

The active controller synchronizes its startup configuration with the standby controller and the rest of the stack members. You can recover the previous flash configuration of the standby controller and the stack members by issuing the **stack unconfigure** command. For an example of this command and the output generated, refer to [Unconfiguring a stack](#) on page 217.

The active controller may reset the rest of the stack members, if necessary. However, if the active controller itself must be reset because configuration has changed or new images have loaded, you must use the **reload** command..

Standby controller

In addition to the active controller, another stack member is elected as the standby controller. If the active controller fails, the standby controller takes over based on the following criteria:

1. If hitless-failover enable is not configured, the standby reloads all units, including itself. It reloads to become the active controller.
2. If hitless-failover enable is configured, the standby immediately takes over the active controller role without reloading any unit.
3. If the entire stack reloads and the active controller does not come up, the standby waits for four minutes to take over by reloading every unit, including itself.

The standby controller synchronizes its configuration with the active controller at each reset.

Bootup role

When a stack unit boots, it boots in a particular role, active controller, standby controller, or stack member, or as a standalone device. When the bootup role is standby controller or stack member, the CLI available to the unit is limited to **show** and **stack** commands. A unit in the role of standby controller or stack member does not act without instructions from the active controller.

The last line of the **show version** output identifies the unit role unless the unit is in standalone mode.

```
My stack unit ID = 1, bootup role = active
My stack unit ID = 3, bootup role = standby
```

NOTE

To convert a standby controller or stack member to a standalone device, use the **stack unconfigure me** command (refer to [Unconfiguring a stack](#) on page 217).

Active controller and standby controller elections

Whenever there is a topology change in the stack (a reset occurs, a unit fails, a stacking port changes state, or members are added or removed), elections are held to determine the status of the active controller and standby controller. The results of the election take effect after the next stack reset.

Certain conditions, in a particular order, determine which units serve as active controller and standby controller after an election. The hierarchy of factors achieves a predictable winner, regardless of the boot up sequence for a unit.

Active and standby controller elections are determined in a slightly different way when hitless failover (the default) is enabled. The order reduces traffic interruptions during unit reset.

- **Boot as active controller** - Indicates that a unit was previously active controller before the current boot sequence and will again assume the role of active controller when two standalone units are combined into a stack. When a third standalone unit joins the stack, the current active controller becomes subject to the other factors in this list. You can upgrade your current active controller to "boot as active controller" status by executing the **write memory** command. The system interprets the **write memory** action as a directive to maintain the current active controller role regardless of resets or a new unit joining the stack.
- **Greater number of members** - The unit that has control over the greater number of stack members.
- **Failover unit** - In a two-unit stack, the unit that is active controller after a failover and has an up time of more than 10 minutes, when the second unit has an up time of less than three minutes.
- **Priority** - The unit with the highest priority value.

- Longer up time - The unit with the longest up time if the up time is at least 30 seconds longer than for any other unit. When up times are compared, there is no effect if the difference is less than 30 seconds.
- Lowest boot stack ID - The unit that has the lowest boot stack ID. Unit ID 1 is the lowest. The unit ID may be 1 through 12.
- MAC address - The member with the lowest MAC address.

When hitless failover is disabled, the following factors, in the order shown, are used to determine active and standby controllers.

- Boot as active controller - Indicates that a unit was previously active controller before the current boot sequence and will again assume the role of active controller when two standalone units are combined into a stack. When a third standalone unit joins the stack, the current active controller becomes subject to the other factors in this list. You can upgrade your current active controller to "boot as active controller" status by executing the **write memory** command. The system interprets the **write memory** action as a directive to maintain the current active controller role regardless of resets or a new unit joining the stack.
- Priority - The unit with the highest priority value.
- Greater number of members - The unit that has control over the greater number of stack members.
- Longer up time - An up time that is more than 30 seconds longer than the next one in size is considered. Where up times are compared, there is no effect if the difference is less than 30 seconds.
- Lowest boot stack ID - The unit that has the lowest boot stack ID. Unit ID 1 is the lowest. The unit ID may be 1 through 12.
- MAC address - The member with the lowest MAC address.

Active controller and standby controller resets

If hitless stacking failover is enabled, when an active controller is reset or removed from the stack, the standby controller takes over immediately.

NOTE

Hitless stacking failover is enabled by default.

The stack behaves differently when a failover occurs depending on whether `hitless-failover enable` is configured. If it is not configured and the active controller is reset or removed from the stack, the standby reloads the entire stack. The standby reloads to become the active controller. If `hitless-failover enable` is configured, the standby takes over immediately without reloading any unit.

If both the active and the standby controllers are removed, the rest of the stack continues to function because the other stack members are operating on whatever is programmed in the hardware. However, the stack members are not able to learn any new addresses. In this case, the following message is displayed every few minutes.

```
Stack member is non-operational because of no Active or standby controller  
You can recover to standalone mode by "stack unconfigure me"
```

Use the **stack unconfigure me** command to restore the units as standalone devices with a pre-stacking configuration.

Standby controller selection based on priority configuration

You can choose a standby controller by configuring a stack unit with the second highest priority or with the same priority as the active controller. The standby controller takes over when the active controller fails. If the original active controller becomes active again, it does not win back its active role, which helps to minimize traffic interruption on the stack. However, if the original active controller has the higher priority and hitless failover is enabled, the active controller regains its role without resetting other stack units. If hitless failover is disabled, the active controller resets the other stack units after it regains control.

Two-unit stack controller selection scenario

In a two-unit stack, you can ensure that one unit resumes the active controller role after a reset by assigning it a higher priority. However, assigning the two units the same priority reduces the number of resets during failover.

The following steps occur on failover when hitless failover is enabled and both members of a two-unit stack are configured with the same priority:

1. Unit 1 (the active controller) resets.
2. The stack fails over to the standby controller (Unit 2).
3. Unit 1 returns to operation with the role of stack member.
4. Unit 2 (now acting as controller) sends a stack merge request to Unit 1.
5. Unit 1 resets and rejoins the stack as the standby controller.

If the active controller has a higher priority than the standby controller in a two-unit stack, the following steps occur:

1. Unit 1 (the active controller) resets.
2. The stack fails over to the standby controller (Unit 2).
3. Unit 1 returns to operation.
4. Unit 2 (now acting as controller) sends a stack merge request to Unit 1.
5. Unit 1 resets and rejoins the stack as the standby controller.
6. Unit 2 schedules a switchover to make Unit 1 the active controller. No unit is reset for the switchover.

Standby controller election criteria

Standby controller election is based on the following criteria:

- The highest priority
- Bootup as active controller
- Bootup as standby controller
- The lowest boot stack ID
- The lowest MAC address.

Stack unit priority

A unit with a higher priority is more likely to be elected active controller. The priority value can be from 0 through 255, with a priority of 255 being the highest. The default priority value assigned to the active controller and standby controller is 128.

You can assign the highest priority value to the stack unit you want to function as the active controller. When you enter a new priority value for a stack unit, that value takes effect immediately but does not affect the current active controller until the next reset. However, with hitless stacking failover enabled, the stack unit with the highest priority will become the active controller in about five minutes.

NOTE

Hitless stacking failover is enabled by default.

You can give your active controller and standby controllers the same priority or different priorities (active controller highest, standby controller second-highest). If the active controller and standby controller have the same priority, when the active controller fails and a standby controller with more members attached takes over, the original active controller is not able to resume its role.

However, if the priority of the active controller is higher than the priority of the standby controller, and if hitless stacking failover is disabled, the old active controller will regain its role and will reset the other units. If hitless stacking failover is enabled, the old active controller (with the higher priority) will become a standby controller, and later, the system will perform an internal switchover to make the old active controller the active controller without resetting other units.

As an example, suppose both the active controller and standby controller have the same priority. If there are more than two units in a stack and the active controller leaves and comes back, it cannot win back the active role because the new active controller now has more members, and the old active controller has none.

If hitless stacking failover is enabled (the default) and there are only two units in a stack, both the old active controller and the new active controller have no members, so the unit with the higher priority wins the active role. If the active and standby controller have the same priority, then the unit with the longer up time wins. If the old active controller stops responding or reloads, the standby controller takes over immediately. When the old active controller reloads and comes back as an active controller, there are two active controllers, which causes the stacks to merge. The old active controller loses the active controller election regardless of its priority because the new active controller is a failover unit (assuming it has an up time of more than 10 minutes and the other unit has an up time of less than three minutes, due to reset). Consequently, the old active controller is reloaded by the new active controller and boots up as a member. Then it is assigned the standby controller role. If the former active controller has a higher priority, the system triggers an internal switchover to make it the new active controller. If the former active controller has an equal priority, it remains the standby controller.

When the active controller and standby controller have the same priority, the system allows a stack switchover as long as hitless stacking failover is enabled. Hitless stacking failover allows the active controller and standby controller to switch roles without traffic interruption.

If you want to assign the same priority to the active controller and the standby controller, you must do so after the stack is formed. This prevents the intended standby controller from becoming the active controller during stack construction.

Changing the priority of a stack member triggers an election that takes effect immediately unless the active controller role changes and hitless stacking failover is disabled, in which case the member priority changes do not take effect until after the next stack reload. With hitless stacking failover, the stack unit with the highest priority becomes the active controller without reload.

To display stack member priority values, enter the **show stack** command.

```
ICX7750-48XGC# configure terminal
ICX7750-48XGC(config)# stack unit 3
ICX7750-48XGC(config-unit-3)# show stack
alone: standalone, D: dynamic config, S: static config
ID   Type      Role      Mac Address  Pri  State  Comment
1 S   ICX7750-48XGC active    0000.00eb.a900 128 local  Ready
2 S   ICX7750-48XGC standby   0000.004f.4243 0 remote Ready, member after reload
3 S   ICX7750-48XGC member    0000.005d.a100 200 remote Ready, active after reload
```

Changing the priority of a stack unit

To change the priority value for a stack unit, enter the **priority** command at the stack unit configuration level. The priority can be a value from 0 through 255, where 255 is the highest priority.

```
device# configure terminal
device(config)# stack unit 1
device(config-unit-1)# priority 128
```

Stack software images

Consider the notes in this section when upgrading or downgrading a stack.

Refer to the release notes and to the *Ruckus FastIron Software Upgrade Guide* for instructions about upgrading the software.

Confirming stack software versions

All units in a stack must be running the same software image. To confirm this, check the software version on all devices that you want to add to a stack. Upgrade any units that are running older versions of the software before you build the stack.

To check the software version for each stack member, perform the following steps.

1. Use Telnet or SSH or connect to any of the console ports in the stack.
2. Enter the **show version** command. Output similar to the following is displayed.

```
ICX7750-26Q Router# show version
Copyright (c) 2017 Ruckus Wireless, Inc. All rights reserved.
UNIT 1: compiled on Jul 31 2015 at 18:37:27 labeled as SWR08040b1
(20197181 bytes) from Primary SWR08040b1.bin
SW: Version 08.0.40b1T203
UNIT 2: compiled on Jul 31 2015 at 18:37:27 labeled as SWR08040b1
(20197181 bytes) from Primary SWR08040b1.bin
SW: Version 08.0.40b1T203
UNIT 3: compiled on Jul 31 2015 at 18:37:27 labeled as SWR08040b1
(20197181 bytes) from Primary SWR08040b1.bin
SW: Version 08.0.40b1T203
Compressed Boot-Monitor Image size = 1835008, Version:10.1.01T205 (swz10101)
Compiled on Fri Jun 27 22:01:35 2014
```

NOTE

If any unit in the stack is running an incorrect version of the software, it will appear as non-operational. You must install the correct software version on that unit for it to operate properly in the stack.

Stack mismatches

When a stack mismatch occurs, the active controller can put any stack member into a non-operational state, which disables all of the ports except the stacking ports. Stack mismatches can occur for a variety of reasons.

NOTE

After a stack mismatch, the active controller can still download an image to the non-operational unit.

The active controller generates a log message whenever it puts a stack unit into a non-operational state. The following examples describe the types of mismatches and the related log message:

- Advanced feature mismatch - The active controller is enabled for advanced features (such as BGP), and the stack unit is not enabled.

```
Stack: Unit 2 0000.0020.0100 doesn't have the matching advanced feature privileges
```

- Image mismatch - A stack unit is running a different software image than the active controller is running.

```
Stack: Unit 2 0000.0020.0100 image mismatch
```

- Configuration mismatch - The module configuration for a stack unit does not match the reserved configuration on the active controller.

```
Stack: Unit 2 0000.0020.0100 config mismatch
```

- Memory allocation mismatch - The active controller does not have enough memory to accommodate the stack unit.

```
Stack: Malloc failure for unit 2.0000.0020.0100
```

Advanced feature privilege mismatch

Advanced feature privileges must be enabled to run features such as BGP. For advanced features to operate across the stack, both the active controller and standby controller must be enabled for advanced features. A unit that is not enabled for these features is put into a non-operational state.

If the active controller is *not* enabled for advanced features, these features will not operate on the stack.

Minor mismatch for stack units

With a minor mismatch, an operating stack can still exist, but traffic is dropped from all ports except the stacking ports for units with the mismatched software. You can download the correct image to the mismatched devices from the active controller. A minor software mismatch means that there is no IPC or election algorithm change, but there is a release version disparity. Minor software mismatches can occur with patch release upgrades. The system logs and displays a message similar to the following.

```
Warning! put stack unit 2 to non-operational reason=image mismatch
```

The **show stack** command displays output similar to the following.

```
T=1h10m1.8: alone: standalone, D: dynamic cfg, S: static
ID  Type          Role      Mac Address  Pri State  Comment
1   S ICX7750-26QXG active    748e.f8f9.6300  0 local  Ready
2   S ICX7750-26QXG member    cc4e.2438.7280  0 remote NON-OP: image mismatch
3   S ICX7750-26QXG standby   cc4e.2438.7500  0 remote  Ready

      active          standby
      +----+          +----+          +----+
=2/1| 1 |2/4==2/1| 3 |2/4--2/1| 2 |2/4=
|   +----+          +----+          +----+ |
|-----|
```

Normally, the system recovers from a minor image mismatch using the Auto Image Copy feature. However, if the feature has been disabled or if the configuration of a stack unit does not match the configuration of the active controller, the stack unit does not function. In this example, unit 2 is non-operational due to an image mismatch. To correct this situation, use the **copy flash flash** command. Refer to [Copying the flash image to a stack unit from the active controller](#) on page 207.

Major mismatch for stack units

A major mismatch indicates an Interprocessor Communications (IPC)-related data structure change, an election algorithm change, or a version of the software that does not support stacking. This can happen when the software undergoes a major change (such as a change from 08.0.80 to 08.0.90). When a major mismatch occurs, the system logs and displays a message similar to the following.

```
T=5h38m43.9: Warning! Recv 6004 IPC in 10m from 609c.9f2a.97e0 e1/2/1: wrong version 105 != 107.  
Please make sure all stack units run the same image.
```

In a major mismatch, the stack cannot be built and will not operate. You must download the correct version of the software to the mismatched units individually.

Configuration mismatch for stack units

Generally, when a stack unit is added to or removed from the stack, its static configuration is not overwritten by the active controller. However, the active controller deletes the dynamic configuration for a unit if it leaves the stack.

A configuration mismatch occurs when the base module configuration for a replacement stack unit does not match the runtime configuration on the active controller. If the configuration on the active controller is static, it cannot be overwritten by the new configuration, and a configuration mismatch occurs.

Configuration mismatches can occur during manual setup when a unit is moved from one stack to another stack or when the ID of a unit is changed by stack interactive-setup.

When you renumber identical units using stack interactive-setup, the configurations are not mapped to the new units (because they match exactly). However, if you switch the IDs of units that are not identical, a configuration mismatch occurs.

When a configuration mismatch occurs, port-related functions on all ports are disabled on the mismatched unit (except for the stacking ports). All other functions are unaffected. For example, the active controller can still copy the unit's image or reset the unit.

Recovering from a stack unit configuration mismatch

When a configuration mismatch occurs, the active controller logs and displays a configuration mismatch message and puts the mismatched unit into a non-operational state. In the following example, the original stack unit 3 has failed, and a replacement unit has been installed that does not match the configuration of the original unit. You should see the following message.

```
Warning! put stack unit 3 to non-operational reason= config mismatch
```

Complete the following steps to recover from a configuration mismatch.

1. Enter the **show stack** command to see the status of the stack, and the **show running-config** command to see the configurations of the stack units.

```
ICX7750-26Q Router# show stack
T=1h38m40.5: alone: standalone, D: dynamic cfg, S: static
ID  Type           Role      Mac Address      Pri State  Comment
1   S ICX7750-26QXG active  748e.f8f9.6300   0 local  Ready
2   D ICX7750-26QXG member  cc4e.2438.7280   0 remote Ready
3   S ICX7750-26QXG member  cc4e.2438.7500   0 remote NON-OP: config mismatch

ICX7750-26Q Router# show running-config
Current configuration:
!
ver 08.0.90
!
stack unit 1
  module 1 icx7750-20-qxg-port-management-module
  module 2 icx7750-qsfp-6port-qsfp-240g-module
  module 3 icx7750-6q-6port-qsfp-240g-module
  stack-trunk 1/2/1 to 1/2/2
  stack-trunk 1/2/4 to 1/2/6
stack unit 2
  module 1 icx7750-20-qxg-port-management-module
  module 2 icx7750-qsfp-6port-qsfp-240g-module
  module 3 icx7750-6q-6port-qsfp-240g-module
  stack-port 2/2/1
  stack-trunk 2/2/4 to 2/2/5
stack unit 3
  module 1 icx7750-48-xgc-port-management-module
  module 2 icx7750-qsfp-6port-qsfp-240g-module
  stack-port 3/2/1
  stack-port 3/2/4
stack enable
stack mac 748e.f8f9.6300
!
```

2. To resolve the mismatch, you must remove the configuration for stack unit 3. Use the **no stack unit** command in configuration mode.

```
device# configure terminal
device(config)# no stack unit 3
```

This removes configuration related to unit 3.

If you are unable to remove the configuration because of a multi-slot trunk configuration or other configuration identified by system output, you must first manually remove the problem configuration.

When you have successfully deleted the mismatched stack unit, a re-election is triggered, and the active controller learns the correct module configuration from the standby controller or from other stack members. No reload is required.

Memory allocation failure

A memory allocation (malloc) failure occurs when the active controller does not have enough memory to run a stack unit. This failure may occur if you configure a large number of VLANs (for example, 4000) or STP instances (for example, 255) in the router image. A memory allocation failure message means that the active controller is low on memory after allocating these resources and does not have enough remaining memory to control a stack member. You can correct this by reducing the number of VLANs or STP instances.

NOTE

After you make configuration changes, such as the number of VLANs or STP instances, you must reset the stack.

Auto Image Copy for stack units

The Auto Image Copy feature ensures that all units in a stack are running the same flash image after a stack merge. This feature also enables automatic reload of the stack units. It prevents the image mismatch that occurs when one or more member units join the stack with a different running image and signature than the active controller and standby controller.

Auto Image Copy is enabled by default on devices, and the user does not have to manually copy the active controller's running image to the mismatched members.

Auto Image Copy limitations

The following limitations apply to the Auto Image Copy feature:

- Auto Image Copy is applicable only to those stack units that are in a non-operational image mismatch state.
- Auto Image Copy does not work if there is a major image mismatch, when the image version of the IPC is different from the stack unit version.
- Auto Image Copy does not work if the user has copied a different image into the flash, creating a mismatch in versions between the flash and the running image on the active controller for the stack.

Verifying Auto Image Copy

Use the **show stack** command to check for any units in the mismatch state after the stack is formed. The following example shows that stack unit 2 is not operational, due to an image mismatch.

```
T=1h10m1.8: alone: standalone, D: dynamic cfg, S: static
ID  Type           Role      Mac Address      Pri State  Comment
1   S ICX7750-26QXG active  748e.f8f9.6300   0 local  Ready
2   S ICX7750-26QXG member  cc4e.2438.7280   0 remote NON-OP: image mismatch
3   S ICX7750-26QXG standby cc4e.2438.7500   0 remote  Ready

      active           standby
      +----+         +----+         +----+
=2/1| 1 |2/4==2/1| 3 |2/4--2/1| 2 |2/4=
|   +----+         +----+         +----+ |
|-----|
```

Disabling Auto Image Copy

Auto Image Copy is enabled by default. However, if you wish to disable this feature, enter the following command in global configuration mode.

```
device# configure terminal
device(config)# image-auto-copy disable
```

Use the **no image-auto-copy disable** command to re-enable Auto Image Copy. This restarts Auto Image Copy immediately and ensures that all stack units have the same image.

NOTE

You can use the **show running-config** or the **show stack detail** command to see if Auto Image Copy is disabled.

Copying the flash image to a stack unit from the active controller

You can replace a bad image on a stack unit or an image that does not match the active controller's image by copying the correct flash image from the active controller.

NOTE

In most cases, you do not have to manually copy the flash image to a mismatched stack unit. For more information, refer to [Auto Image Copy for stack units](#) on page 206.

To copy the flash image to the primary flash memory of a stack unit from the active controller primary flash, enter the **copy flash flash** command followed by the keyword **unit-id-pri** and the stack unit number as shown in the following example.

```
device# copy flash flash unit-id-pri 2
```

The example copies active controller primary flash to the primary flash for stack unit 2.

You can also copy flash to more than one stack unit at the same time as shown in the following example.

```
device# copy flash flash unit-id-pri 2,3,5-8
```

The example copies active controller primary flash to stack units 2 and 3 and 5 through 8.

Use the keyword **unit-id-sec** to copy from active controller primary flash as shown in the following example.

```
copy flash flash unit-id-sec 2-4
```

The example copies active controller secondary flash to stack units 2 through 4.

For additional information on **copy flash** commands, refer to the *Ruckus FastIron Command Reference*.

Configuring stacking trunks in a live environment

To create or modify a trunk in a production environment, use the **multi-stack-trunk** command. The **multi-stack-trunk** command is used to ensure that a stack trunk is formed on two directly connected stack units at the same time. The **multi-stack-trunk** command can only be enabled on the active controller unit.

By configuring a multi-stack-trunk on two sets of connected stack ports, a trunk-to-port connection is avoided. A trunk-to-port connection is formed when one side of the ports forms a trunk, and the other side of the ports does not. A trunk-to-port connection can result in dropped packets and can potentially break a stacking link.

The following example shows a trunk being formed between stack units 1 and 2 and another trunk being formed between stack units 2 and 3.

```
device(config)# stack unit 1
device(config-unit-1)# multi-stack-trunk 1/2/3 to 1/2/4 and 2/2/1 to 2/2/2
device(config-unit-1)# stack unit 2
device(config-unit-2)# multi-stack-trunk 2/2/3 to 2/2/4 and 3/2/1 to 3/2/2
```

Use the **no** form of the **multi-stack-trunk** command to remove the stacking trunk configuration.

Displaying multi-trunk stacking configuration

The **multi-stack-trunk** command is used on live stacks and is effectively a combination of two **stack-trunk** commands to ensure that a trunk-to-trunk connection is created on both ends of a stack link simultaneously. When the **multi-stack trunk** command is used to create a trunk, the configuration is saved as stack trunk ports, and the running configuration displays the stack trunk details on both ends under the heading `stack unit <unit> configuration`.

```
ICX7750-48C Router# configure terminal
ICX7750-48C Router(config)# stack unit 1
ICX7750-48C Router(config-unit-1)# multi-stack-trunk 1/2/4 to 1/2/6 and 2/2/4 to 2/2/6
```

In the previous example, a two-port trunk is created between stack units 1 and 2. This example enlarges the two-port trunk to a three-port trunk.

Use the **show running-config** command to display the related configuration under **stack-trunk** and **stack-port**. For the multi-stack trunk created in the previous example, the running or startup configuration displays the following configuration for the **show running-config** command.

```
ICX7750-48C Router# show running-config
Current configuration:
!
ver 08.0.90
!
stack unit 1
module 1 icx7750-48-xgc-port-management-module
module 2 icx7750-qsfp-6port-qsfp-240g-module
stack-port 1/2/1
stack-trunk 1/2/4 to 1/2/6

stack unit 2
module 1 icx7750-48-xgc-port-management-module
module 2 icx7750-qsfp-6port-qsfp-240g-module
stack-port 2/2/1
stack-trunk 2/2/4 to 2/2/6

stack enable
!
!
```

Error messages encountered when configuring a stacking trunk

The following error messages may occur when you configure a trunk on a Ruckus ICX stack:

- If you form a multi-trunk connection on two sets of stack ports that are not directly connected on neighboring units, the **multi-stack-trunk** command is rejected, and an error message similar to the follow example is displayed.

```
Error! 1/2/3 has no connection. Please use "stack-trunk".
```

- When a unit joins or leaves a stack, or a stack trunk is configured using the **stack-trunk** command, a stack election is triggered. The **multi-stack-trunk** command triggers a stack election among the stack units and reprograms (or removes) the stack trunk port in the hardware. A timer is set on all units to coordinate a stack election. Traffic is generally interrupted for less than 5 seconds for the system to detect the port down event and reprogram hardware. You must wait for the stack election to be completed before entering another command. If you do not wait for the stack election to finish, the following warning message is displayed.

```
Stack port or trunk change is in progress, please try later.
```

- You cannot enter the **stack switch-over** command until the stack election is completed or until the **multi-stack-trunk** command configuration is complete. If you enter the **stack switch-over** command too early, the following warning message is displayed.

```
Please try later, reason: during stack port or trunk deployment.
```

Configuring stacking ports in a live environment

You can use the **multi-stack-port** command (similar to the **multi-stack-trunk** command) to change a live stack-trunk to a stack-port. The **no multi-stack-port** command removes a live stack link.

The following example replaces a live stack-trunk with a stack-port on both units.

```
ICX7750-48F Router(config)#stack unit 1
ICX7750-48F Router(config-unit-1)#multi-stack-port 1/2/4 and 3/2/4

Config changed due to add/del units. Do write mem if you want to keep it

ICX7750-48F Router(config-unit-1)#show stack
T=3h26m25.6: alone: standalone, D: dynamic cfg, S: static
ID  Type      Role      Mac Address  Pri State  Comment
1   S  ICX7750-48XGF  active    609c.9f7f.9400 128 local  Ready
2   D  ICX7750-20QXG  standby   cc4e.2438.7280  0 remote Ready
3   S  ICX7750-20QXG  member    748e.f8f9.6300  0 remote Ready

      active              standby
      +---+             +---+
=2/1| 1 |2/4--2/4| 3 |2/1==2/4| 2 |2/1=
| +---+             +---+
| |
|-----|
Will assign standby in 49 sec due to all ready

Standby u2 - protocols ready, can failover
Role history: N: standalone, A: active, S: standby, M: member
U1: N->A

Current stack management MAC is 609c.9f7f.9400

ICX7750-48F Router(config-unit-1)# show running-config
Current configuration:
!
ver 08.0.90devT203
!
stack unit 1
  module 1 icx7750-48-xgf-port-management-module
  module 2 icx7750-qsfp-6port-qsfp-240g-module
  module 3 icx7750-6q-6port-qsfp-240g-module
  priority 128
  stack-trunk 1/2/1 to 1/2/3
  stack-port 1/2/4
stack unit 2
  module 1 icx7750-20-qxg-port-management-module
  module 2 icx7750-qsfp-6port-qsfp-240g-module
  module 3 icx7750-6q-6port-qsfp-240g-module
  stack-trunk 2/2/1 to 2/2/3
  stack-trunk 2/2/4 to 2/2/6
stack unit 3
  module 1 icx7750-20-qxg-port-management-module
  module 2 icx7750-qsfp-6port-qsfp-240g-module
  module 3 icx7750-6q-6port-qsfp-240g-module
  stack-trunk 3/2/1 to 3/2/3
  stack-port 3/2/4
stack enable
stack mac 609c.9f7f.9400
```

NOTE

Both the **multi-stack-trunk** and the **multi-stack-port** commands perform numerous checks to make sure no unit would become unreachable. However, the checks have limitations. Verify the physical connections with the **show stack connection** command, and make sure that reducing or removing stack-ports or stack-trunks will not break the stack.

NOTE

Reducing or removing live stack-trunks or stack-ports changes stacking ports to data ports. This creates Layer 2 loops if no Spanning Tree Protocol is configured in the default VLAN. Ruckus recommends that you either disconnect these ports or disable them.

Adding, removing, or replacing units in a stack

You can add, remove, or replace stack units using interactive-setup or manually using static configuration. The recommended method is to connect units to the stack before you supply power to the units; however, you can also connect powered units.

Installing a new unit in a stack using stack interactive-setup

This method can be applied to clean units or units that have existing configurations.

1. Connect the new unit to the stack by connecting the appropriate stacking ports.
2. Run stack interactive-setup on the active controller, and assign an ID to the new unit. The active controller resets the new unit.
3. Once the new unit boots and joins the stack, enter the **write memory** command on the active controller.

Removing a unit from a stack

To remove a unit from the stack, disconnect the cables from the stacking ports. This can be done whether the units are powered on or powered off. When you remove a unit that is powered on, it is still in stacking-enabled mode. To remove the stacking files, enter the **stack unconfigure me** or **stack unconfigure clean** command.

The **stack unconfigure me** command returns a unit to the state it had before joining a stack and recovers its startup configuration. The **stack unconfigure clean** command removes the unit's startup configuration. When you issue either command, the unit operates as a standalone unit once it reboots.

When a unit is removed from a stack, the active controller deletes the unit configuration if it has been dynamically learned. Refer to [Stacking terminology](#) on page 19 for definitions of static and dynamic configurations.

Stack unit replacement

You can replace any stack unit except the active controller with a clean unit of the same model without entering any commands. Discovery and unit replacement are completed in approximately one to two minutes; however, additional time is required to reload the new unit.

To replace a unit, the following are required:

- The unit being replaced must have a static configuration. Use the **show stack** command as shown in the following procedures to check for an "S" next to the unit, indicating its configuration is static.
- The physical modules of the replacement unit must match one and only one provisional configuration, that is, a stored configuration without a physical unit present.

- The replacement unit must be a clean unit. You can convert a unit to a clean unit using the **erase startup-config** command followed by the **reload** command without saving any configuration.

Stack unit replacement is performed for one unit at a time to handle any setup.

NOTE

Starting with release 08.0.90, connecting the stack units with IDs in ascending or descending sequential order is no longer required.

Unit replacement limitations

Starting with release 08.0.90, stack unit replacement does not work in the following cases:

- Multiple units are being replaced simultaneously. In this case, use stack interactive-setup or stack zero-touch provisioning to discover the stack units.
- The modules on the replacement unit do not match any provisional configuration.
- The modules on the replacement unit match more than one provisional configuration.
- Stack zero-touch provisioning is enabled.

Replacing a stack unit automatically with a clean unit

- (Optional) Enter the **show stack** command on the active controller, and check for an "S" beside the unit to confirm that the configuration for the unit you are replacing is static.
- If the configuration is not static, enter the **write memory** command to change all dynamic configurations to static. A static configuration remains after the unit is removed.

After the configuration is saved with the write memory command, all unit IDs are followed by an "S" as shown in the following example.

```
ICX7750-26Q Router# show stack
T=3h24m36.1: alone: standalone, D: dynamic cfg, S: static
ID  Type           Role      Mac Address      Pri State  Comment
1   S ICX7750-26QXG active   cc4e.2438.7280  128 local  Ready
2   S ICX7750-48XGF member   609c.9f7f.9400   0 remote Ready
3   S ICX7750-26QXG standby  748e.f8f9.6300   0 remote Ready

      active           standby
      +----+         +----+         +----+
=2/1| 1 |2/4==2/1| 3 |2/4==2/4| 2 |2/1|=
|   +----+         +----+         +----+ |
|-----|
```

When you remove a unit with a static configuration, the configuration is still present. The **show stack** command output lists the unit state as "reserve" as shown in the following example for unit 2.

```
ICX7750-26Q Router# show stack
T=3h25m53.4: alone: standalone, D: dynamic cfg, S: static
ID  Type           Role      Mac Address      Pri State  Comment
1   S ICX7750-26QXG active   cc4e.2438.7280  128 local  Ready
2   S ICX7750-48XGF member   0000.0000.0000   0 reserve
3   S ICX7750-26QXG standby  748e.f8f9.6300   0 remote  Ready

      active           standby
      +----+         +----+
2/1| 1 |2/4==2/1| 3 |2/4
      +----+         +----+
```

Stack Management

Adding, removing, or replacing units in a stack

3. Remove the old unit from the stack.

Although the unit is absent, the provisional configuration for the unit is still retained on the active controller.

4. Make sure that the hardware (module) configuration of the replacement unit is identical to the hardware configuration of the unit you removed.
5. Connect the new unit to the stack using the same stacking ports as the old unit.

If the replacement unit configuration matches the configuration retained on the active controller, the active controller resets the new unit. The new unit becomes a member and joins the stack, and the stack keeps its original topology.

Replacing a stack unit with stack interactive-setup

You must use stack interactive-setup to replace stack units in the following cases:

- The replacement is not a clean unit.
- You do not want the active controller to trigger an automatic replacement.
- You are replacing multiple units simultaneously.

NOTE

If you are replacing more than one unit simultaneously, you may also use stack zero-touch provisioning to discover the units; however, stack interactive-setup allows interactive control of the process.

NOTE

If you use stack interactive-setup to assign a new unit an ID that has mismatched static configuration, the utility displays a warning message that the new unit will be put in a non-operational state after it joins the stack.

NOTE

You can return a configuration-mismatched unit to operation by configuring the **no stack unit** command for the nonoperational unit from the active controller. This removes the entire stack configuration so the active controller can learn the configuration-mismatched unit as a new unit. The active controller triggers an election and learns the unit. Refer to [Recovering from a stack unit configuration mismatch](#) on page 204 for more information.

To replace a stack unit with stack interactive-setup, perform the following steps.

1. (Optional) Enter the **show stack** command on the active controller, and check for an "S" beside the unit to confirm that the configuration for the unit you are replacing is static.
2. If the configuration is not static, enter the **write memory** command to change all dynamic configurations to static. A static configuration remains after the unit is removed.
3. Remove the old stack unit from the stack.
4. Connect the new unit to the existing stack using the same stacking ports as the old unit.
5. Enter the **stack interactive-setup** command. Select interactive-setup option 2 if the replacement unit is a clean unit. Select interactive-setup option 3 if the replacement unit contains configuration. Stack interactive-setup suggests an ID based on matching the new unit with the static configurations. You can overwrite the suggested ID by entering the ID of the old unit.

The active controller resets the unit, and it joins the stack.

In the following example, units 2 and 3 are removed and replaced. Because unit configuration has been saved, once the units are removed, the **show stack** command displays the state of both units as "reserve." This indicates that provisional configuration is stored for the two units.

```
ICX7750-26Q Router# show stack
T=3h45m17.5: alone: standalone, D: dynamic cfg, S: static
ID  Type           Role   Mac Address   Pri State  Comment
1   S ICX7750-26QXG active cc4e.2438.7280 128 local  Ready
2   S ICX7750-48XGF member 0000.0000.0000  0 reserve
3   S ICX7750-26QXG member 0000.0000.0000  0 reserve

      active
      +----+
      2/1| 1 |2/4
      +----+
Current stack management MAC is cc4e.2438.7280
```

Stack Management

Adding, removing, or replacing units in a stack

If you connect two clean units matching the physical modules of the units you removed, you can run **stack interactive-setup**.

```
ICX7750-26Q Router# stack interactive-setup
You can abort stack interactive-setup at any stage by <ctrl-c>
0: quit
1: change stack unit IDs
2: discover and convert new units (no startup-config flash) to members
3: discover and convert existing/new standalone units to members
2&3 can also find new links and auto-trunk or convert chain(s) to ring.
Please type your selection: 2
Sending probes to ports: u1: 1/2/1 to 1/2/6,
Existing stack: =====
  active
  +---+
  2/1| 1 |2/4
  +---+
```

Horizontal bars link to discovered units. Vertical bars link to stack units.

```
Chain #0: =====
#1: icx7750-48-xgf-port-management 609c.9f7f.9400
#2: icx7750-20-qxg-port-management 748e.f8f9.6300
```

```
  1/2/1      1/2/4
  ||         ||
  ||         ||
  2/1        2/1
  +---+      +---+
  |#1 |2/4==2/4|#2 |
  +---+      +---+
```

Discovered 1 chain/ring

```
Chain #0: Do you want to select this chain? (enter 'y' or 'n'): y
#1: icx7750-48-xgf-port 609c.9f7f.9400, type an ID (No: 0, default: 2):
#2: icx7750-20-qxg-port 748e.f8f9.6300, type an ID (No: 0, default: 3):
```

You selected 2 unit(s): #1: ID=2, #2: ID=3,

Links U1--U2, #3: 2/1--2/1 2/2--2/2 2/3--2/3

Links U2--U3, #3: 2/4--2/4 2/5--2/5 2/6--2/6

Links U3--U1, #3: 2/1--2/4 2/2--2/5 2/3--2/6

```
          #1          #2
  +---+      +---+      +---+
=2/4| 1 |2/1==2/1| 2 |2/4==2/4| 3 |2/1=
|  +---+      +---+      +---+ |
|                                     |
|-----|
```

Proceeding will produce the above topology. Do you accept it? (enter 'y' or 'n'): y

stack interactive-setup discovers 2 unit(s) and sends stack-port/trunk to chain 0:

#1 609c.9f7f.9400 U2, D0: 2/1 to 2/3, D1: 2/4 to 2/6

#2 748e.f8f9.6300 U3, D0: 2/1 to 2/3, D1: 2/4 to 2/6

```
ICX7750-26Q Router#
```

```
T=3h49m1.5: Election, was active, no change, ID=1, pri=128, 2U(1-2), A=u1, nbr#=1 0, reason: u2: port-up, ,
Detect stack unit 2 has different startup config flash, will synchronize it
```

```
Detect stack unit 2 has different ssh rsa host key, will synchronize it
```

```
T=3h48m43.9: Done hot swap: active controller u1 sets u2 to Ready.
```

```
T=3h48m45.4: Synchronize startup config to u2
```

```
Flash Memory Write (8192 bytes per dot)
```

```
.
Write startup-config done.
```

```
Stack unit 2 Power supply 1 is up
```

```
Stack unit 2 Power supply 2 is not present
```

```
SSH RSA Host Key erase request sent to specified stack member(s)...
```

```
T=3h48m52.4: Synchronize ssh rsa host key to u2
```

```
T=3h49m22.3: Election, was active, no change, ID=1, pri=128, 2U(1-2), A=u1, nbr#=1 0, reason: u1: port-up, ,
```

```
T=3h49m24.9: Election, was active, no change, ID=1, pri=128, 3U(1-3), A=u1, nbr#=1 1, reason: u3: port-up, ,
```

```

!!! Temperature is over warning level on stack unit 1 !!!
Detect stack unit 3 has different startup config flash, will synchronize it
Detect stack unit 3 has different ssh rsa host key, will synchronize it
T=3h49m7.9: Done hot swap: active controller u1 sets u3 to Ready.
T=3h49m7.9: Synchronize startup config to u3
Flash Memory Write (8192 bytes per dot)
.
Write startup-config done.
T=3h49m31.3: Election, was active, no change, ID=1, pri=128, 3U(1-3), A=u1, nbr#=1 1, reason: u2: port-up, ,
Stack unit 3 Power supply 1 is up
Stack unit 3 Power supply 2 is down
T=3h49m35.5: Election, was active, no change, ID=1, pri=128, 3U(1-3), A=u1, nbr#=2 2, reason: u3: port-up, ,
SSH RSA Host Key erase request sent to specified stack member(s)...
T=3h49m16.7: Synchronize ssh rsa host key to u3

ICX7750-26Q Router#

```

When the interactive-setup process is complete, output for the **show stack** command confirms that the configuration is the same. The provisional configuration has been applied to the two replacement units, 2 and 3, and the state has changed to "remote" for both units.

```

ICX7750-26Q Router# show stack
T=3h49m27.4: alone: standalone, D: dynamic cfg, S: static
ID  Type           Role      Mac Address      Pri State  Comment
1   S ICX7750-20QXG active  cc4e.2438.7280  128 local  Ready
2   S ICX7750-48XGF member  609c.9f7f.9400   0 remote Ready
3   S ICX7750-20QXG member  748e.f8f9.6300   0 remote Ready

      active
      +---+      +---+      +---+
=2/1| 1 |2/4==2/1| 3 |2/4==2/4| 2 |2/1=
|  +---+      +---+      +---+ |
|-----|
There is no standby. Will assign a standby in 47 sec

Current stack management MAC is cc4e.2438.7280

```

Moving a unit to another stack

Moving a member from one stack to another stack can cause non-sequential ID assignment. The active controller will honor the original ID of the newly added unit if the ID is not already in use. The active controller assigns a new ID if the original ID is already in use. You can use the **stack interactive-setup** command to change the ID of the new unit. Refer to [Changing stack unit IDs with stack interactive-setup](#) on page 75 for more information.

Removing an active controller from a powered stack

To remove an active controller from a powered stack, disconnect the active controller. The standby controller waits for 30 seconds and then assumes the role of active controller. If hitless failover is enabled on the stack, the standby controller takes over immediately. A single active controller device functions as a standalone unit even if it is still stacking-enabled. You do not have to issue a **stack unconfigure me** command for an active controller.

Reloading a stack unit

Use the **reload** command to reload one or more stack units, for example, when necessary to repair a malfunctioning unit. Stack units can be reloaded only if they are not the active controller.

When the **reload** command is entered on the active controller without the **unit-id** parameter as shown in the following example, the entire stack reloads.

```
device# reload
```

NOTE

If you need to reload the active controller, use the **stack switch-over** command. When switchover occurs, the original active controller can be reloaded using the **reload unit-id** command.

You can specify a list of stack members to reload as shown in the following example.

```
device# reload unit-id 1,2,4-8
```

The example reloads units 1 and 2 and units 4 through 8.

For additional information on the reload command, refer to the *Ruckus FastIron Command Reference*.

Managing stack partitioning

Ring topology stacks do not partition when a stack member fails. Operation is interrupted briefly while the stack recalculates a new path. Ring topologies are more stable than linear topologies because they provide redundant pathways in case of accidental failure.

When a unit in a stack with a linear topology fails, the stack divides (partitions) into two or more separate stacks that all have the same configuration. This may cause an IP address conflict in the network. To keep the stacks separate, change the IP address of each new stack.

When a stack breaks into partitions, the partition with the active controller remains operational. If a partition contains the standby controller, this partition becomes operational because the standby controller assumes the active role and reloads the partition units. However, if hitless failover is enabled, the partition units are not reloaded. A partition without an active controller or standby controller does not function. To reconfigure these units to act in standalone mode, you must first enter a **stack unconfigure me** command on each unit.

To reverse the partitioning, reconnect all of the units into the original stack topology using the stacking ports. This is the same as merging stacks. If the original active controller again has the highest priority, it regains its role. If two partition active controllers have the same priority, the active controller with the most stack members is elected. This process helps minimize traffic interruption.

Merging stacks

Ruckus ICX stacks may be merged, but the total number of stack units must not exceed the maximum stack supported by the device. For example, you could combine two stacks of ICX 7750 devices with four units each into a single stack of eight units.

NOTE

You cannot use interactive-setup to merge stacks because interactive-setup does not work across stack boundaries.

You can merge stacks by connecting them together using the stacking ports. Before doing this, make sure that no stacking ports (for example, ports on an end unit in a linear stack topology) have been reconfigured as data ports.

When stacks are merged, an election is held among the active controllers. The winning controller retains its configuration and the IDs of all of its original stack members. The remaining stack units lose their configuration and are reset. If the IDs of the losing stack units conflict with the IDs of the winning units, they may change, and the IDs will no longer be sequential.

NOTE

You can use interactive-setup to renumber the members in the newly merged stack. Refer to [Changing stack unit IDs with stack interactive-setup](#) on page 75 for more information.

The following examples show how stack merging works:

- If a stack partitions into multiple stacks because of a connection failure, you can fix the connection and the stack partitions will merge back into the original stack with no change to stack IDs because all stack IDs are distinct.
- In a linear stack topology, the end units of the stack have only one stacking port configured. Before you can merge two linear stacks, you must reconfigure the end units so that both ports are stacking ports.

Unconfiguring a stack

The **stack unconfigure** command is a runtime command that returns stack units to their pre-stacking state. When a stack unit is unconfigured, its stacking flash is removed, and its startup-config.txt flash file is recovered. These actions apply to all units to which this command is applied, regardless of the role of the unit in the stack.

When the **stack unconfigure** command is applied to the active controller, it removes **stack enable** from the runtime configuration but not from the startup configuration. If you want to remove the **stack enable** command from the active controller permanently, you must enter the **write memory** command after the **stack unconfigure** command.

When the **stack unconfigure** command is applied to the standby controller or a stack member (besides the active controller), it removes **stack enable** from the recovered startup-config.txt file and resets the unit.

NOTE

When a stack member becomes a standalone unit after the **stack unconfigure** command, it could become a clean unit if it had no startup configuration flash. When a clean unit matches the active controller's static configuration, the active controller integrates the clean unit into the stack. Thus, the standalone unit is reloaded to be a member of the stack.

Users can avoid this problem by disconnecting the member unit from the stack and issuing the **stack unconfigure me** command on the unit to change it to a standalone unit.

To remove the configuration from the current stack unit, enter the following command.

```
device# stack unconfigure me
```

To remove the configuration from the current unit, including the startup configuration, so that the unit reboots as a clean unit, enter the following unit on the stack member console.

```
device# stack unconfigure clean
```

NOTE

The **stack unconfigure clean** command can be entered only on the stack member console.

To remove the configuration from the entire stack, enter the following command on the active controller for the stack.

```
device# stack unconfigure all
```

To remove the configuration from a specific stack unit, on the active controller for the stack, enter the **stack unconfigure** command followed by the stack unit ID as shown in the following example.

```
device# stack unconfigure 3
```

The example unconfigures stack unit 3.

NOTE

The **stack unconfigure me** command can be entered from any unit; however, **stack unconfigure all** and **stack unconfigure stack-unit** commands can be issued only on the active controller.

The following example shows a session where stack unit 2 is unconfigured.

```
ICX7750-48XGC# show stack
alone: standalone, D: dynamic config, S: static config
ID  Type      Role      MAC Address      Pri State      Comment
1 S  ICX7750-48XGC active  0000.00eb.a900   128 local      Ready
2 S  ICX7750-48XGC standby 0000.004f.4243   0  remote      Ready
3 S  ICX7750-48XGC member  0000.0001.0100   0  remote      Ready
ICX7750-48XGC# stack unconfigure 2
Will recover pre-stacking startup config of this unit, and reset it. Are you sure? (enter 'y' or 'n'): y
Stack 2 deletes stack bootup flash and recover startup-config.txt from .old
ICX7750-48XGC# show stack
alone: standalone, D: dynamic config, S: static config
ID  Type      Role      MAC Address      Pri State      Comment
1 S  ICX7750-48XGC active  0000.00eb.a900   128 local      Ready
2 S  ICX7750-48XGC member  0000.0000.0000   0  reserved
3 S  ICX7750-48XGC standby 0000.0001.0100   0  remote      Ready
```

When the **stack unconfigure 2** command is issued, stack unit 2 recovers the startup-config.txt from the startup-config.old configuration file that was saved when this unit downloaded its configuration from the active controller. As the output shows, stack member 2 has been removed from the stack, and ID 2 is now reserved for a replacement unit. Stack member 3 is now the standby controller.

Syslog, SNMP, and traps for stack units

Syslog messages from stack units are forwarded to, and can be viewed from, the active controller.

All stack units support SNMP gets, sets, and traps, which are managed by the active controller. An SNMP trap is sent from a stack unit to the stack active controller and forwarded from the active controller to an SNMP-configured server. An external network management station can execute SNMP gets and sets for MIBs and collect information about any port on the stack.

SNMP traps can be configured for the insertion or removal of a stack unit or uplink module, and for optic identification.

For more information about syslog messages, refer to the *Ruckus FastIron Management Configuration Guide*.

Configuring SNMP for a stack

SNMP server and feature configuration is the same for a stack as for standalone units. In a stack, SNMP gets and sets are processed by the active controller for the standby controller and all stack members. SNMP traps generated by the standby controller and stack members are propagated to the configured SNMP server through the active controller. For more information about how to configure an SNMP server for ICX devices, refer to the *Ruckus FastIron Management Configuration Guide*.

SNMP engine IDs for stackable devices

NOTE

Beginning with FastIron release 08.0.20, when a stack is enabled, "hitless-failover enable" configuration is added, and a default stack MAC address is assigned if none is configured. The MAC address of the unit is displayed in **show stack** command output.

For Ruckus stacking devices, if an engine ID is not manually created or a stack MAC address is not specified and saved, the stack loses its engine ID when the active controller fails and the standby controller takes over because the standby controller creates a

new engine ID at bootup. To prevent this from happening, create a new engine ID or a new stack MAC address to save the engine ID to the startup configuration. This should be done before the SNMPv3 user is created.

If a new active controller is elected (for example, the standby controller becomes the active controller), you will see the following results:

- If you have configured the engine ID and saved it to the startup configuration file, the new stack configuration uses the saved engine ID.
- If you have not configured an engine ID, but a stack MAC address is configured, the new stack configuration retains the original engine ID because it is based on the stack MAC address.
- If you have not configured an engine ID and no stack MAC address is configured, the new stack configuration uses the default engine ID. The default engine ID is based on the stack's own management MAC address for the new active controller. Because the engine ID has changed, any SNMPv3 clients must be reconfigured with the new engine ID.

Displaying stack information

This section describes the **show** commands for a stack and includes output examples and field descriptions.

Displaying stacking topology

The **show stack connection** command displays the topology and a detailed connection report. It also displays connection errors or hardware failures as shown in the following sample output.

```
ICX7750-48F Router# show stack connection
Probing the topology. Please wait ...
ICX7750-48F Router#
  active
  +---+      +---+      +---+      +---+      +---+      +---+
-2/1| 1 |2/4--3/1| C |3/4==2/1| B |2/4==2/1| A |2/4--2/1| 9 |2/4--2/1| 8 |2/4-
| +---+      +---+      +---+      +---+      +---+      +---+
|
| standby
| +---+      +---+      +---+      +---+      +---+      +---+
-2/4| 2 |2/1--2/4| 3 |2/1--2/4| 4 |2/1==2/4| 5 |2/1--2/4| 6 |2/1==2/4| 7 |2/1-
  +---+      +---+      +---+      +---+      +---+      +---+

trunk probe results: 12 links
Link 1: u1 -- u2, num=1
1: 1/2/1 (P0) <---> 2/2/4 (P1)
Link 2: u1 -- u12, num=1
1: 1/2/4 (P1) <---> 12/3/1 (P0)
Link 3: u2 -- u3, num=1
1: 2/2/1 (P0) <---> 3/2/4 (P1)
Link 4: u3 -- u4, num=1
1: 3/2/1 (P0) <---> 4/2/4 (P1)
Link 5: u4 -- u5, num=2
1: 4/2/1 (T0) <---> 5/2/4 (T1)
2: 4/2/2 (T0) <---> 5/2/5 (T1)
Link 6: u5 -- u6, num=1
1: 5/2/1 (P0) <---> 6/2/4 (P1)
Link 7: u6 -- u7, num=3
1: 6/2/1 (T0) <---> 7/2/4 (T1)
2: 6/2/2 (T0) <---> 7/2/5 (T1)
3: 6/2/3 (T0) <---> 7/2/6 (T1)
Link 8: u7 -- u8, num=1
1: 7/2/1 (P0) <---> 8/2/4 (P1)
Link 9: u8 -- u9, num=1
1: 8/2/1 (P0) <---> 9/2/4 (P1)
Link 10: u9 -- u10, num=1
1: 9/2/1 (P0) <---> 10/2/4 (P1)
Link 11: u10 -- u11, num=2
```

Stack Management

Displaying stack information

```
1: 10/2/1 (T0) <---> 11/2/4 (T1)
2: 10/2/2 (T0) <---> 11/2/5 (T1)
Link 12: u11 -- u12, num=2
1: 11/2/1 (T0) <---> 12/3/4 (T1)
2: 11/2/2 (T0) <---> 12/3/5 (T1)
CPU to CPU packets are fine between 12 units.
```

TABLE 28 Field definitions for the show stack connection command

Field	Description
P0, P1	P identifies a stack-port. The 0 or 1 identifies its direction.
T0, T1	T identifies a stack-trunk. The 0 or 1 identifies its direction.

Displaying running configuration information

The **show running-config** command displays information about the current stack configuration as shown in the following example. Some configuration information, such as sz registrar, is added by default.

```
ICX7750-48F Router# show running-config
Current configuration:
!
ver 08.0.90devT203
!
stack unit 1
  module 1 icx7750-48-xgf-port-management-module
  module 2 icx7750-qsfp-6port-qsfp-240g-module
  module 3 icx7750-6q-6port-qsfp-240g-module
  priority 128
  stack-trunk 1/2/1 to 1/2/3
  stack-trunk 1/2/4 to 1/2/6
stack unit 2
  module 1 icx7750-20-qxg-port-management-module
  module 2 icx7750-qsfp-6port-qsfp-240g-module
  module 3 icx7750-6q-6port-qsfp-240g-module
  stack-trunk 2/2/1 to 2/2/3
  stack-trunk 2/2/4 to 2/2/6
stack unit 3
  module 1 icx7750-20-qxg-port-management-module
  module 2 icx7750-qsfp-6port-qsfp-240g-module
  module 3 icx7750-6q-6port-qsfp-240g-module
  stack-trunk 3/2/1 to 3/2/3
  stack-trunk 3/2/4 to 3/2/6
stack enable
stack mac 609c.9f7f.9400
!
!
aaa authentication web-server default local
aaa authentication login default local
enable aaa console
!
no telnet server
username super password .....
!
!
hitless-failover enable
!
!
sz registrar
sz active-list 10.150.35.201
!
!
interface management 1
ip address 10.176.159.215 255.255.255.128
!
end
```

TABLE 29 Field descriptions for the show running-config command

Field	Description
ver	Software version the stack is running
stack unit #	The stack identification number for this unit
module #	Identifies the configuration for each module installed in the stack unit
priority	Indicates the priority assigned to the stack unit
stack-port	Lists stacking ports configured on the stack unit
stack-trunk	Indicates the trunk configuration
stack enable	Indicates whether the stack is enabled
stack mac	Specifies the mac address for the stack
aaa authentication web-server default local	Indicates the authentication method to access the device through web management is to use local username and password
aaa authentication login default local	Indicates the authentication method to access the device through cli via telnet/ssh is to use local username and password
enable aaa console	Indicates authentication, authorization, and accounting (AAA) is enabled on the console
(no) telnet server	Indicates whether telnet server is enabled or not on this device
hitless-failover enable/disabled	Indicates whether hitless failover is enabled
sz registrar	Present by default and indicates that the device can initiate auto-discovery of up to two configured SmartZone management IP addresses by querying a pre-configured URL. Refer to SmartZone administrator guides for more information.
sz active-list <i>ip address, ip address</i>	Displays the list of IP addresses used by the ICX device to connect to SmartZone. Refer to SmartZone administrator guides for more information.
interface management 1	Indicates FastIron management port
ip address	Indicates the IP address that identifies the stack

How the show running-config command displays configured stacking ports

FastIron release 08.0.90 always display stacking ports regardless of whether **stack enable** is configured. FastIron releases prior to 08.0.90 may not display stacking ports when **stack enable** is not configured. In all releases, stacking ports can be used as data ports if **stack enable** is not configured.

Displaying software version information

The **show version** command shows the software version that the stack is running. The last line of the output shows the bootup ID and role for the unit. Output resembles the following example.

```
ICX7750-26Q Router# show version
Copyright (c) Ruckus Networks, Inc. All rights reserved.
UNIT 2: compiled on Jan 22 2019 at 10:59:04 labeled as SWR08090
(30097250 bytes) from Primary SWR08090.bin
SW: Version 08.0.90devT203
Compressed Primary Boot Code size = 1835520, Version:10.1.15T205 (swz10115b3)
Compiled on Mon Dec 17 11:02:22 2018
UNIT 1: compiled on Jan 22 2019 at 10:59:04 labeled as SWR08090
(30097250 bytes) from Primary SWR08090.bin
SW: Version 08.0.90devT203
Compressed Primary Boot Code size = 1835520, Version:10.1.15T205 (swz10115b3)
UNIT 3: compiled on Jan 22 2019 at 10:59:04 labeled as SWR08090
(30097250 bytes) from Primary SWR08090.bin
SW: Version 08.0.90devT203
```

Stack Management

Displaying stack information

```
Compressed Primary Boot Code size = 1835520, Version:10.1.15T205 (swz10115b3)

HW: Stackable ICX7750-26Q
Internal USB: Serial #: 40D60C003CF90180
Vendor: UNIGEN, Total size = 1910 MB
=====
UNIT 1: SL 1: ICX7750-48XGF 48-port Management Module
Serial #:CRH3330M012
Software Package: ICX7750_L3_SOFT_PACKAGE
Current License: l3-prem
=====
UNIT 1: SL 2: ICX7750-QSFP 6-port QSFP 240G Module
=====
UNIT 1: SL 3: ICX7750-6Q 6-port QSFP 240G Module
=====
UNIT 2: SL 1: ICX7750-20QXG 20-port Management Module
Serial #:CRK2246J01Y
Software Package: ICX7750_L3_SOFT_PACKAGE
Current License: l3-prem
P-ASIC 2: type B850, rev 03 Chip BCM56850_A2
=====
UNIT 2: SL 2: ICX7750-QSFP 6-port QSFP 240G Module
=====
UNIT 2: SL 3: ICX7750-6Q 6-port QSFP 240G Module
Serial #:CRK2246J010
=====
UNIT 3: SL 1: ICX7750-20QXG 20-port Management Module
Serial #:CRK2234J00J
Software Package: ICX7750_L3_SOFT_PACKAGE
Current License: l3-prem
=====
UNIT 3: SL 2: ICX7750-QSFP 6-port QSFP 240G Module
=====
UNIT 3: SL 3: ICX7750-6Q 6-port QSFP 240G Module
Serial #:4J04N
=====
1500 MHz Power PC processor (version 8023/0022) 88 MHz bus
8192 KB boot flash memory
2048 MB code flash memory
3840 MB DRAM
STACKID 2 system uptime is 50 minute(s) 6 second(s)
STACKID 1 system uptime is 55 minute(s) 55 second(s)
STACKID 3 system uptime is 10 minute(s) 25 second(s)
The system started at 13:51:45 GMT+00 Tue Jul 27 2004

The system : started=warm start reloaded=by "reload"
My stack unit ID = 2, bootup role = active
```

The **show version unit *unit-num*** command displays the software version running on an individual unit. The command output is similar to the following example.

```
ICX7750-26Q Router# show version unit 1
Copyright (c) Ruckus Networks, Inc. All rights reserved.
UNIT 1: compiled on Jan 22 2019 at 10:59:04 labeled as SWR08090
(30097250 bytes) from Primary SWR08090.bin
SW: Version 08.0.90devT203
Compressed Primary Boot Code size = 1835520, Version:10.1.15T205 (swz10115b3)
=====
UNIT 1: SL 1: ICX7750-48XGF 48-port Management Module
Serial #:CRH3330M012
Software Package: ICX7750_L3_SOFT_PACKAGE
Current License: l3-prem
=====
UNIT 1: SL 2: ICX7750-QSFP 6-port QSFP 240G Module
=====
UNIT 1: SL 3: ICX7750-6Q 6-port QSFP 240G Module
=====
STACKID 1 system uptime is 1 hour(s) 4 minute(s) 34 second(s)
```

Displaying stack flash information

Use the **show flash** command to display flash memory information for all members of a stack or for a specified stack member.

The following example shows output from the active controller for the entire stack (the stack has three members).

```
ICX7750-26Q Router# show flash
Stack unit 1:
  Compressed Pri Code size = 30097250, Version:08.0.90dT203 (SWR08090.bin)
  Compressed Sec Code size = 30070348, Version:08.0.90dT203 (SWR08090.bin)
  Compressed Pri Boot Code size = 1835520, Version:10.1.15T205
  Compressed Sec Boot Code size = 1835520, Version:10.1.15T205
  Code Flash Free Space = 755814400
Stack unit 2:
  Compressed Pri Code size = 30097250, Version:08.0.90dT203 (SWR08090.bin)
  Compressed Sec Code size = 30070348, Version:08.0.90dT203 (SWR08090.bin)
  Compressed Pri Boot Code size = 1835520, Version:10.1.15T205 (swz10115b3)
  Compressed Sec Boot Code size = 1835520, Version:10.1.15T205 (swz10115b3)
  Code Flash Free Space = 743022592
Stack unit 3:
  Compressed Pri Code size = 30097250, Version:08.0.90dT203 (SWR08090.bin)
  Compressed Sec Code size = 30070348, Version:08.0.90dT203 (SWR08090.bin)
  Compressed Pri Boot Code size = 1835520, Version:10.1.15T205
  Compressed Sec Boot Code size = 1835520, Version:10.1.15T205
  Code Flash Free Space = 753475584
```

The following example shows output for stack member 3 only.

```
ICX7750-26Q Router# show flash unit 3
Stack unit 3:
  Compressed Pri Code size = 30097250, Version 08.0.90dT203 (SWR08090.bin)
  Compressed Sec Code size = 30070348, Version 08.0.90dT203 (SWR08090.bin)
  Compressed Pri Boot Code size = 1835520, Version 10.1.15T205
  Compressed Sec Boot Code size = 1835520, Version 10.1.15T205
  Code Flash Free Space = 753475584
```

TABLE 30 Field definitions for the show flash command

Field	Description
Compressed Pri Code size	The compressed size, version, and image name for the Primary Code
Compressed Sec Code size	The compressed size, version, and image name for the Secondary Code
Compressed Boot-Monitor Image size	The compressed size and version for the BootROM Code
Code Flash Free Space	The amount of available free space in Flash memory

Displaying stack memory information

The **show memory** command displays information about stack units. The following example shows output for a stack with three units.

```
ICX7750-26Q Router# show memory
Stack unit 1:
Total DRAM: 3853299712 bytes
  Dynamic memory: 3853299712 bytes total, 3105505280 bytes free, 19% used
Stack unit 2:
Total DRAM: 3853299712 bytes
  Dynamic memory: 3853299712 bytes total, 3091406848 bytes free, 19% used
Stack unit 3:
Total DRAM: 3853299712 bytes
  Dynamic memory: 3853299712 bytes total, 3125997568 bytes free, 18% used
```

TABLE 31 Field definitions for the show memory command

Field	Description
Total DRAM	The size (in bytes) of DRAM
Dynamic memory	The total number of bytes in dynamic memory, including the number of bytes that are available (free or unused) and the percentage of memory used.

Displaying stack chassis information

The **show chassis** command displays chassis information for each stack unit. Output resembles the following example for the first unit in a stack.

```

ICX7750-48F Switch# show chassis
The stack unit 1 chassis info:

Power supply 1 present, status failed
Power supply 2 (AC - Regular) present, status ok
    Model Number:    3I50
    Serial Number:   P148121227
    Firmware Ver:    1.41
Power supply 2 Fan Air Flow Direction:  Front to Back

Fan 1 ok, speed (auto): [[1]]<->2
Fan 2 ok, speed (auto): [[1]]<->2
Fan 3 ok, speed (auto): [[1]]<->2
Fan 4 ok, speed (auto): [[1]]<->2

Fan controlled temperature: 49.5 deg-C

Fan speed switching temperature thresholds:
    Speed 1: NM<----->58          deg-C
    Speed 2:    50<-----> 82 deg-C (shutdown)

Fan 1 Air Flow Direction:  Front to Back
Fan 2 Air Flow Direction:  Front to Back
Fan 3 Air Flow Direction:  Front to Back
Fan 4 Air Flow Direction:  Front to Back
CPU Temperature Readings:
    Current temperature : 33.5 deg-C
Left Fan Temperature Readings:
    Current temperature : 49.5 deg-C
Right Fan Temperature Readings:
    Current temperature : 42.5 deg-C
Module Fan Temperature Readings:
    Current temperature : 47.0 deg-C
Left PSU Temperature Readings:
    Current temperature : 39.0 deg-C
Right PSU Temperature Readings:
    Current temperature : 34.0 deg-C
Left Front Temperature Readings:
    Current temperature : 37.0 deg-C
Middle Front Temperature Readings:
    Current temperature : 38.0 deg-C
Right Front Temperature Readings:
    Current temperature : 33.0 deg-C
Back 40G module Temperature Readings:
    Current temperature : 44.5 deg-C
    Warning level.....: 70.0 deg-C
    Shutdown level.....: 82.0 deg-C
Boot Prom MAC : 748e.f8f9.2500
Management MAC: 748e.f8f9.2500
  
```

TABLE 32 Field definitions for the show chassis command

Field	Description
Power supply 1	The status of the primary power supply
Power supply 2	The status of the secondary power supply, if present
Fan 1 through Fan 4	The status of the cooling fans, including speed, temperature reading, temperature range, and airflow direction
Fan controlled temperature	Measured temperature reading
Fan speed switching temperature thresholds (Speed 1, Speed 2)	Operating ranges for fan speeds 1 and 2, with the shutdown temperature indicated at the upper end of the temperature range for speed 2
Current temperature (by component)	Current temperature readings, in degrees Centigrade, for CPU, left fan, right fan, module fan, left power supply, right power supply, left front, middle front, right front, and back 40 Gbps module
Back 40G module Temperature Readings	For the rear 40 Gbps module, current temperature, warning level temperature, and shutdown level temperature
Exhaust Side Temperature Readings	From the air exhaust side of the chassis, the current temperature reading, the warning level temperature setting, and the shutdown level temperature setting
Intake Side Temperature Readings	The current temperature reading from the air intake side of the chassis
Boot Prom MAC	The MAC address of the boot prom
Management MAC	For the active controller only, the management MAC address

Displaying stack module information

The **show module** command displays information about stack unit modules. Output resembles the following.

```
ICX7750-26Q Router# show module
Module                               Status Ports Starting MAC
U1:M1 ICX7750-26QXG 20-port Management Module OK      56 748e.f8f9.6300
U1:M2 ICX7750-QSFP 6-port QSFP 240G Module OK      24 748e.f8f9.6315
U1:M3 ICX7750-6Q 6-port QSFP 240G Module OK      24 748e.f8f9.631b
U2:M1 ICX7750-26QXG 20-port Management Module OK      56 cc4e.2438.7280
U2:M2 ICX7750-QSFP 6-port QSFP 240G Module OK      24 cc4e.2438.7295
U2:M3 ICX7750-6Q 6-port QSFP 240G Module OK      24 cc4e.2438.729b
U3:M1 ICX7750-26QXG 20-port Management Module OK      56 cc4e.2438.7500
U3:M2 ICX7750-QSFP 6-port QSFP 240G Module OK      24 cc4e.2438.7515
U3:M3 ICX7750-6Q 6-port QSFP 240G Module OK      24 cc4e.2438.751b
```

TABLE 33 Field definitions for the show module command

Field	Description
Module	Identifies the module by stack unit ID, module number, and module type
Status	The status of this module
Ports	The number of ports in this module
Starting MAC	The starting MAC address for this module

Displaying general or detailed information about stack members

You can display information about any member in a stack by entering **show** commands from the active controller console port. If you enter **show** commands from a unit that is not the active controller, the information may not be displayed correctly.

Stack Management

Displaying stack information

The **show stack** command displays general information about a stack, for all members, for a specified member, or for all members with additional detail.

The following output covers the entire stack and includes role history for each unit, beginning with the initial role the unit held.

```
ICX7750-26Q Router# show stack
T=29m36.7: alone: standalone, D: dynamic cfg, S: static
ID Type          Role      Mac Address  Pri State Comment
1S ICX7750-26QXG standby 748e.f8f9.6300 128 remote Ready
2S ICX7750-26QXG member cc4e.2438.7280 0 remote Ready
4S ICX7750-26QXG active  cc4e.2438.7500 128 local  Ready
```

```

      active          standby
      +----+          +----+
-2/1| 4 |2/4--2/1| 2 |2/4--2/1| 1 |2/4-
|  +----+          +----+
|-----|
|-----|
```

Standby u1 -protocols ready, can failover or manually switch over

Role history: N: standalone, A: active, S: standby, M: member

U1: N->A->S->M->S, U2: M->S->A->S->M, U4: M->S->A

If you add a stack member ID, output is displayed for that member only.

```
ICX7750-26Q Router# show stack 1
T=12m6.2: alone: standalone, D: dynamic cfg, S: static
ID Type          Role      Mac Address  Pri State Comment
1 S ICX7750-26QXG active 748e.f8f9.6300 0 local  Ready
```

```
ICX7750-26Q Router# show stack 2
T=12m16.3: alone: standalone, D: dynamic cfg, S: static
ID Type          Role      Mac Address  Pri State Comment
2 D ICX7750-26QXG member cc4e.2438.7280 0 remote Ready
```

```
ICX7750-26Q Router# show stack 3
T=12m20.6: alone: standalone, D: dynamic cfg, S: static
ID Type          Role      Mac Address  Pri State Comment
3 D ICX7750-26QXG standby cc4e.2438.7500 0 remote Ready
```

If you add the **detail** keyword to the **show stack** command, output resembles the following example.

```
ICX7750-26Q Router# show stack detail
T=18m33.4: alone: standalone, D: dynamic cfg, S: static
ID Type          Role      Mac Address  Pri State Comment
1 S ICX7750-26QXG active 748e.f8f9.6300 0 local  Ready
2 D ICX7750-26QXG member cc4e.2438.7280 0 remote Ready
3 D ICX7750-26QXG standby cc4e.2438.7500 0 remote Ready
```

```

      active          standby
      +----+          +----+
=2/1| 1 |2/4==2/1| 3 |2/4--2/1| 2 |2/4=
|  +----+          +----+
|-----|
|-----|
```

Will assign standby in 11 sec due to all ready

Standby u3 - protocols ready, can failover
Current stack management MAC is 748e.f8f9.6300

Image-Auto-Copy is Enabled.

Unit#	Stack-port1	Stack-port2	Neighbors	Stack-port2
1	up (1/2/1-1/2/2)	up (1/2/4-1/2/6)	U2 (2/2/4-2/2/5)	U3 (3/2/1-3/2/3)
2	up (2/2/1)	up (2/2/4-2/2/5)	U3 (3/2/4)	U1 (1/2/1-1/2/2)
3	up (3/2/1-3/2/3)	up (3/2/4)	U1 (1/2/4-1/2/6)	U2 (2/2/1)

```
Unit# System uptime
1      18 minute(s) 33 second(s)
2      17 minute(s) 30 second(s)
3      18 minute(s) 46 second(s)
```

TABLE 34 Field descriptions for the show stack command

Field	Description
alone: Standalone	This device is operating as a standalone device.
S: static configuration	The configuration for this unit is static (has been saved with a write memory command).
D: dynamic configuration	The configuration for this unit is dynamic and may be overwritten by a new stack unit. To change to a static configuration, enter the write memory command.
ID	The stack identification number for this unit
Type	The model of this unit
Role	The role of this unit within the stack
MAC address	The MAC address of this unit
Pri (Priority)	The priority assigned to this unit
State	The operational state of this unit
Comments	Additional information about this unit (optional)
Role history	Tracks up to six role changes per stack unit. The initial state is always displayed. Overflow is indicated by ellipses (...). Standby to member role changes are not displayed. Role history also does not display the transition after bootup of a non-active controller unit from member to standby.

NOTE

The active controller removes the dynamic configuration of a unit when the unit leaves the stack. However, if there is a static trunk configuration associated with the unit, the active controller cannot remove the dynamic configuration. In this case, you must remove the static trunk and use the **no stack unit stack-unit** command to manually remove the configuration.

TABLE 35 Field descriptions for the show stack detail command

Field	Description
Stack Port Status	Indicates stacking port status for each stack unit
Neighbors	Identifies stack neighbors (by unit ID) for each stack unit
Unit #	The stack identification number for this unit
Stack-port 1	Indicates the port state (up or down) and identifies the port by number (stack-ID/slot/port)
Stack-port 2	Indicates the port state (up or down) and identifies the port by number (stack-ID/slot/port)

Displaying information about stack neighbors

The **show stack neighbors** command displays information about stack member neighbors.

```
ICX7750-26Q Router# show stack neighbors
U#      Stack-port1      Stack-port2
1      (1/2/1-1/2/2) to U2 (2/2/4-2/2/5) (1/2/4-1/2/6) to U3 (3/2/1-3/2/3)
2      (2/2/1) to U3 (3/2/4) (2/2/4-2/2/5) to U1 (1/2/1-1/2/2)
3      (3/2/1-3/2/3) to U1 (1/2/4-1/2/6) (3/2/4) to U2 (2/2/1)
```

TABLE 36 Field descriptions for the show stack neighbors command

Field	Description
U#	The stack identification number for this unit
Stack-port1	Identifies the neighbor stack unit for stack-port1 for this unit ID
Stack-port2	Identifies the neighbor stack unit for stack-port2 for this unit ID

Displaying stack port information

The **show stack stack-ports** command displays information about stack port status. Equal signs (=) in command output show connections between trunk ports.

```
ICX7750-26Q Router# show stack stack-ports
      active      standby
      +---+      +---+      +---+
=2/1| 1 |2/4==2/1| 3 |2/4--2/1| 2 |2/4=
| +---+      +---+      +---+ |
|-----|
U#  Stack-port1      Stack-port2
1   up (1/2/1-1/2/2) up (1/2/4-1/2/6)
   up ports: 1/2/1
   up ports: 1/2/4
2   up (2/2/1)       up (2/2/4-2/2/5)
   up ports: 2/2/4
3   up (3/2/1-3/2/3) up (3/2/4)
   up ports: 3/2/1
```

TABLE 37 Field descriptions for the show stack stack-ports command

Field	Description
ID	The stack identification number for this unit
Stack-port1	Indicates port state (up or down) and identifies the port by number (stack-ID/slot/port)
Stack-port 2	Indicates port state (up or down) and identifies the port by number (stack-ID/slot/port)

Displaying stacking port statistics

The **show statistics stack-ports** command displays information about all stacking ports in a stack topology.

```
device# show statistics stack-ports
Port      In Packets  Out Packets  In Errors  Out Errors
1/2/1     22223      4528         0          0
1/2/2     35506      3844         0          0
2/2/1     3161       34173        0          0
2/2/2     24721      3676         0          0
3/2/1     3048       23881        0          0
3/2/2     13540      2857         0          0
4/2/1     2862       13537        0          0
4/2/2     3626       3184         0          0
5/2/1     3183       3621         0          0
5/2/2     3265       13508        0          0
6/2/1     14020      3655         0          0
6/3/1     3652       17705        0          0
7/2/1     17705      3658         0          0
7/3/1     4047       21802        0          0
TOTAL     154559     153629       0          0
```

TABLE 38 Field definitions for the show statistics stack-ports command

Field	Description
Port	The stack identification number for this unit
In Packets	The number of incoming packets on this port
Out Packets	The number of outgoing packets on this port
In Errors	The number of incoming errors on this port
Out Errors	The number of outgoing errors on this port

Displaying stacking port interface information

The **show interfaces stack-ports** command displays information about the stacking ports for all members in a stack.

```
ICX7750-26Q Router# show interfaces stack-ports

Port      Link      State Dupl Speed Trunk Tag Pvid Pri MAC                               Name
1/2/1     Up        Forward Full 40G  None No  N/A  0   748e.f8f9.6315
1/2/2     Down      None    None None  None No  N/A  0   748e.f8f9.6319
1/2/4     Up        Forward Full 40G  None No  N/A  0   748e.f8f9.6321
1/2/5     Down      None    None None  None No  N/A  0   748e.f8f9.6325
1/2/6     Down      None    None None  None No  N/A  0   748e.f8f9.6329
2/2/1     Up        Forward Full 40G  None No  N/A  0   cc4e.2438.7295
2/2/4     Up        Forward Full 40G  None No  N/A  0   cc4e.2438.72a1
2/2/5     Down      None    None None  None No  N/A  0   cc4e.2438.72a5
3/2/1     Up        Forward Full 40G  None No  N/A  0   cc4e.2438.7515
3/2/2     Down      None    None None  None No  N/A  0   cc4e.2438.7519
3/2/3     Down      None    None None  None No  N/A  0   cc4e.2438.751d
3/2/4     Up        Forward Full 40G  None No  N/A  0   cc4e.2438.7521
```

TABLE 39 Field descriptions for the show interfaces stack-ports command

Field	Description
Port	Specifies the stack identification number for this unit
Link	Identifies the configuration for modules on this unit
State	Indicates that a priority has been assigned to this stack unit
Dupl	Indicates whether the port is configured as half- or full-duplex
Speed	Indicates the port speed
Trunk	Indicates whether the port is part of a trunk
Tag	Indicates whether the port is tagged or untagged
Pvid	Port VLAN ID, if applicable
Pri	Specifies port priority
MAC	Provides the MAC address of the port
Name	Displays the optional name assigned to the port if present

NOTE

If a unit is provisional (that is, if it is reserved and does not have a physical unit associated with the unit ID), its interface MAC address shows as 0000.0000.0000.

Displaying IPC statistics for a stack

To display IPC statistics for the stack, enter the **show stack ipc stats** command as shown in the following example.

```
ICX7750-26Q Router# show stack ipc stats
V80, G4, src=748e.f8f9.6300, max_pkt_size=10264, delay_buf=10264
Recv: SkP0: 10823, P1: 12954, sum: 23777, since t=2163.7 ago
```

Stack Management

Displaying stack information

```

Message types have callbacks:
Send message types:
  [1]=9086,      [5]=10922,      [6]=3,          [7]=809,
  [9]=630,      [13]=209,       [22]=17,        [24]=644,
  [28]=29,      [31]=1880,      [40]=15,        [60]=4,
  [77]=130,
Recv message types:
  [1]= 0:3295, 1:4896,      [5]= 0:5269, 1:5622,      [6]= 0:1, 1:2,
  [7]= 0:398, 1:411,      [9]= 0:996, 1:1139,      [13]= 0:544, 1:559,
  [23]= 0:319, 1:325,      [34]= 0:1,
Statistics:
  send pkt num      :      24369,      rcv pkt num      :      23777,
  send msg num      :      24369,      rcv msg num      :      23777,
  send frag pkt num :           0,      rcv frag pkt num :           0,
  pkt buf alloc     :      24376,
  send_delay_msg    :           0,      send_delay_pkt   :           0,
  fwd_stby_msg      :           0,      fwd_stby_pkt     :           0,

  Reliable-mail     send  success  receive  duplic  T (us)
  target ID         2         2         0         0       82226
  target MAC        0         0         0         0       82226
  unrel target ID   5         0         0
  unrel target MAC  4         0

There is 0 current jumbo IPC session

Possible errors:
ICX7750-26Q Router#

```

The following table defines the output fields for the **show stack ipc stats** command.

Output field	Description
Vxx	Version number
Gx	
src	Source MAC address of egress IPC packets (MAC address of this unit).
max_pkt_size	Maximum packet size allowed in network.
rcv	Total packets received.
SkPO	
P1	
sum	Total (P1 + skPO)
since t = x	Elapsed time used for sampling
Send message types	Totals for each type of message sent, displayed in the following format: [x] = total, where "x" represents the number of a message type from the Message types have callbacks list in the command output.
Recv message types	Totals for each type of message received, displayed in the format [x] = total, where "x" represents the number of a message type from the Message types have callbacks list in the command output.
Statistics:	
send pkt num	Total number of packets sent. One packet may contain multiple messages.
rcv pkt num	Total number of packets received. One packet may contain multiple messages.
rcv msg num	Total number of received messages related to Zero-touch or SPX interactive-setup (see list of types in output).
send pkt-msg num	Total number of packets containing Zero-touch or SPX interactive-setup messages sent.
send msg num	Total number of Zero-touch or SPX interactive-setup messages sent.
send frag pkt num	Number of fragmented packets sent.
rcv frag pkt num	Number of fragmented packets received.

Output field	Description
pkt buf alloc	Packet buffer allocation size.
send_delay_msg	Number of delay messages sent
send_delay_pkt	Number of delay packets sent
fwd_stby_msg	Number of standby messages forwarded
fwd_stby_pkt	Number of standby packets forwarded
Reliable mail	Reliable-mail messages are used for essential communications, for example, to assign PE IDs or reload the system. Reliable-mail message statistics for specified target types: <ul style="list-style-type: none"> send: number of reliable-mail messages sent success: number of successful reliable-mail messages (sent and acknowledged) receive: number of packets received duplic: number of duplicate packets sent T-us: Average time in milliseconds between packet transmission and receipt of acknowledgment
target MAC	Number of reliable-mail messages sent using the MAC address as the target address. (Reliable-mail messages are re-transmitted until acknowledgment is received.)
unrel target MAC	Number of unreliable-mail messages using the MAC address as the target address. (Unreliable-mail messages are sent only once.)
Possible errors:	Warnings or errors detected, if any.

Displaying reliable IPC statistics for stack units

Use the **show stack rel-ipc stats** command to display session statistics for stack units. The following example shows reliable IPC statistics for stack unit 3.

```
ICX7750-26Q Router# show stack rel-ipc stats unit 3

Unit 3 statistics:
Msgs: sent 907  rcv 384, Pkt sends failed: 0, KA: sent 1522 rcv 1522

Message types sent:
  [9]=846,      [13]=2,      [15]=31,      [59]=1,
  [76]=3,      [87]=24,

Message types received:
  [9]=366,      [13]=1,      [15]=17,

Session: base-channel, to U3, channel 0
buf size: xmt=4194312, rcv=65544, max msg=32776
State: established (last 19 minute(s) 16 second(s) ago) cnt: 1
Remote resets: 0, Reset packets sent: 0
Connection statistics (for current connection, if established):
Msgs sent: 520, Msgs rcvd: 308
Atomic batches sent: 0, Atomic batches rcvd: 0
Pkts sent: 1325, Pkts rcvd: 945
Msg bytes sent: 262915, Msg bytes rcvd: 131550
Pkt bytes sent: 631680, Pkt bytes rcvd: 247560
Keepalive sent: 231, Keepalive rcvd: 231
Keepalive age: 0, Keepalive NBR age : 1
Flushes requested: 10, Suspends: 0, Resumes: 0
Packets sent with data (DAT), ACKs, and window updates (WND):
Other: 259, ACK: 300, WND: 6, ACK+WND: 0
DAT: 753, DAT+ACK: 7, DAT+WND 0, DA+AC+WND 0
Data retransmits done: 430, Zero-window probes sent: 9
Dup ACK pkts rcvd: 40, Pkts rcvd w/dup data: 0
Pkts rcvd w/data past window: 0

Session: ACL, to U3, channel 3
```

Stack Management

Displaying stack information

```
buf size: xmt=409608, rcv=131080, max msg=1472
State: established (last 19 minute(s) 16 second(s) ago) cnt: 1
Remote resets: 0, Reset packets sent: 0
Connection statistics (for current connection, if established):
Msgs sent: 291, Msgs rcvd: 58
Atomic batches sent: 0, Atomic batches rcvd: 0
Pkts sent: 681, Pkts rcvd: 205
Msg bytes sent: 277656, Msg bytes rcvd: 82128
Pkt bytes sent: 349288, Pkt bytes rcvd: 84820
Keepalive sent: 231, Keepalive rcvd: 231
Keepalive age: 0, Keepalive NBR age : 1
Flushes requested: 0, Suspends: 0, Resumes: 0
Packets sent with data (DAT), ACKs, and window updates (WND):
Other: 232, ACK: 12, WND: 1, ACK+WND: 2
DAT: 429, DAT+ACK: 5, DAT+WND 0, DA+AC+WND 0
Data retransmits done: 272, Zero-window probes sent: 5
Dup ACK pkts rcvd: 20, Pkts rcvd w/dup data: 0
Pkts rcvd w/data past window: 0
```

```
Session: sync-reliable, to U3, channel 4
buf size: xmt=153608, rcv=10248, max msg=1472
State: established (last 16 minute(s) 38 second(s) ago) cnt: 1
Remote resets: 0, Reset packets sent: 0
Connection statistics (for current connection, if established):
Msgs sent: 53, Msgs rcvd: 1
Atomic batches sent: 0, Atomic batches rcvd: 0
Pkts sent: 256, Pkts rcvd: 35
Msg bytes sent: 77380, Msg bytes rcvd: 1460
Pkt bytes sent: 270984, Pkt bytes rcvd: 1884
Keepalive sent: 200, Keepalive rcvd: 200
Keepalive age: 0, Keepalive NBR age : 1
Flushes requested: 0, Suspends: 0, Resumes: 0
Packets sent with data (DAT), ACKs, and window updates (WND):
Other: 201, ACK: 1, WND: 0, ACK+WND: 0
DAT: 54, DAT+ACK: 0, DAT+WND 0, DA+AC+WND 0
Data retransmits done: 41, Zero-window probes sent: 0
Dup ACK pkts rcvd: 17, Pkts rcvd w/dup data: 0
Pkts rcvd w/data past window: 0
```

```
Session: rcon-svr-to-3, to U3, channel 12
buf size: xmt=4008, rcv=8008, max msg=2668
State: established (last 19 minute(s) 14 second(s) ago) cnt: 1
Remote resets: 0, Reset packets sent: 0
Connection statistics (for current connection, if established):
Msgs sent: 31, Msgs rcvd: 17
Atomic batches sent: 0, Atomic batches rcvd: 0
Pkts sent: 300, Pkts rcvd: 49
Msg bytes sent: 3592, Msg bytes rcvd: 155
Pkt bytes sent: 21836, Pkt bytes rcvd: 996
Keepalive sent: 231, Keepalive rcvd: 231
Keepalive age: 0, Keepalive NBR age : 1
Flushes requested: 23, Suspends: 0, Resumes: 0
Packets sent with data (DAT), ACKs, and window updates (WND):
Other: 237, ACK: 14, WND: 0, ACK+WND: 0
DAT: 49, DAT+ACK: 0, DAT+WND 0, DA+AC+WND 0
Data retransmits done: 26, Zero-window probes sent: 0
Dup ACK pkts rcvd: 10, Pkts rcvd w/dup data: 0
Pkts rcvd w/data past window: 0
```

Displaying information on stack zero-touch configuration

1. Enter the `show stack zero-touch ipc` command in Privileged EXEC mode to display information on zero-touch IPC statistics.

```

ICX7750-48F Router# show stack zero-touch ipc
V3, , src=cc4e.246d.9e00, max_pkt_size=1468, rcv 168, send 204
Message types have callbacks:
  3: ZTP-probe                4: ZTP-request
  5: unreliable-mail          6: reliable-mail
  7: test ipc packets         8: cmd-to-new-unit
  9: KA-new-unit

Send message types:
  [4]=200, [6]=4,
Recv message types:
  [3]=160, [6]=8,

Statistics:
send pkt num      :      204,   send pkt-msg num    :      204,
rcv pkt num       :      168,   send msg num       :      204,
rcv msg num       :      168,   pkt buf alloc     :      204,

Reliable-mail      send  success  receive  duplic  T-ms
target MAC         2         2         0        0       2
unrel target MAC   0         0         0        0       0

Possible errors:
ICX7750-48F Router#
  
```

The `show stack zero-touch ipc` command displays the following information.

Output field	Description
V3	Version number
src	Source MAC address of egress IPC packets (MAC address of this unit).
max_pkt_size	Maximum packet size allowed in network.
rcv	Total packets received.
send	Total packets sent.
Send message types	Totals for each type of message sent, displayed in the following format: [x] = total, where "x" represents the number of a message type from the Message types have callbacks list in the command output.
Recv message types	Totals for each type of message received, displayed in the format [x] = total, where "x" represents the number of a message type from the Message types have callbacks list in the command output.
Statistics:	
send pkt num	Total number of packets sent. One packet may contain multiple messages.
rcv pkt num	Total number of packets received. One packet may contain multiple messages.
rcv msg num	Total number of received messages related to Zero-touch or SPX interactive-setup (see list of types in output).
send pkt-msg num	Total number of packets containing Zero-touch or SPX interactive-setup messages sent.
send msg num	Total number of Zero-touch or SPX interactive-setup messages sent.
pkt buf alloc	Packet buffer allocation size.

Output field	Description
Reliable mail	Reliable-mail messages are used for essential communications, for example, to assign PE IDs or reload the system. Reliable-mail message statistics for specified target types: <ul style="list-style-type: none"> • send: number of reliable-mail messages sent • success: number of successful reliable-mail messages (sent and acknowledged) • receive: number of packets received • duplic: number of duplicate packets sent • T-ms: Average time in milliseconds between packet transmission and receipt of acknowledgment
target MAC	Number of reliable-mail messages sent using the MAC address as the target address. (Reliable-mail messages are re-transmitted until acknowledgment is received.)
unrel target MAC	Number of unreliable-mail messages using the MAC address as the target address. (Unreliable-mail messages are sent only once.)
Possible errors:	Warnings or errors detected, if any.

2. Enter the **show stack zero-touch status** command in Privileged EXEC mode to display status information for a new unit.

In the following example, the unit cannot be discovered because it is not a clean unit (it contains configuration). The output explains that the unit can be configured using stack interactive-setup 3.

```
ICX7750-48F Router# show stack zero-touch status
I cannot be discovered by stack zero-touch or interactive-setup option 2. reason: has stack enable
configuration
I can be discovered by stack interactive-setup option 3.
Will clean up in 89.4 sec. Sent last keep-alive 581.1 sec ago.
zero-touch-enable and stack enable are configured. Have done 1 probes
ZTP has converted 0 new units to members.
*** ZTP is going on for 0m0s. state=start. Will trigger again 3 min after done
ZTP postponed due to topology changes: 0
My MAC used in image copy is 748e.f8f9.636e.
ACL #=0, ind=0
```

3. Enter the **show stack zero-touch log** command in Privileged EXEC mode to display the system log for the stack zero-touch and interactive-setup processes. SPX zero-touch and interactive-setup information is also included in the log.

```
ICX7750-48F Router# show stack zero-touch log
Note: The logs are shared by Spx and Stack ZTP/interactive-setup.

8m38.7989 init_zero_touch(1) u_off=0, init_T=5178 , 1U OP AOS0 I1N 5%
9m41.5928 ZTP mode=1, 6 .5min T, cb_state = 0, diff = 580 s, diff=580 > 90 sec, trigger probe, , 1U
OP AOS0 I1N 3%
9m41.8670 Send ZTP probes: ports: 1/2/1 to 1/2/6 1/3/1 to 1/3/6 PEs: , 1U OP AOS0 I1N
9m53.5723 ZTP 100ms: tk=29, st=1, cb_tk=29 mx_tk=30, pb, wa=2, , 1U OP AOS0 I1N
9m53.9720 ZTP 100ms: tk=30, st=1, cb_tk=30 mx_tk=30, ->GET_R, wa=20,, 1U OP AOS0 I1N
10m5.5770 ZTP 100ms: tk=50, st=2, cb_tk=19 m_tk=20, pb, wa=5, , 1U OP AOS0 I1N
10m5.5779 cb_r_probe. ztp_mode=1, rec#=2, load=162, inv [0] cc4e.2439.3700, rec#=2, exist mac=cc4e.
2439.1a00 <= cc4e.2439.3700, cannot overwrite, 1U OP AOS0 I1N
10m5.5781 cb_r_probe. ztp_mode=1, rec#=2, load=162, inv [0] cc4e.2439.1a00, use old 0, , 1U OP
AOS0 I1N
10m5.5782 cb_r_probe_2nd. rec#=2, load=192, tot C=1, ztp_m=1 , 1U OP AOS0 I1N
10m5.9765 stk_ztp_send_id_port_acl C0 mac#=4: 636e 1a63 376b 636e , 1U OP AOS0 I1N
10m5.9766 C0, dr=0 rin=1 me=1/4
#1 cc4e.2439.1a00 U3, D0: 2/1 to 2/3, D1: 2/4 mac: me=1u cb=0: mis-m=0 , 1U OP AOS0 I1N
10m5.9767 C0, dr=0 rin=1 me=2/4
#2 cc4e.2439.3700 U2, D0: 2/1, D1: 2/4 mac: me=2u cb=3: mis-m=0 , 1U OP AOS0 I1N
10m5.9770 Send C0 len=880, 2U: 1a00 3700 res=1 Z_CMD: CB u1 cc4e.246d.9e00, cmd=0, ack=0 #rec=2, d=0
0 0 0, H=28B 875B, ztp_m=10: m=8ef8 S=28(63843) C=110, *** Err: sta28 + size 63843=63871 > 875, 1U
OP AOS0 I1N
10m5.9771 chain 0:
#1 cc4e.2439.1a00 U3, D0: 2/1 to 2/3, D1: 2/4
#2 cc4e.2439.3700 U2, D0: 2/1, D1: 2/4
, 1U OP AOS0 I1N
10m5.9771 Send cleanup 20 sec, rel=1, to (chain# res): Send KA 20s rel=1, C0 1, , 1U OP AOS0 I1N
10m5.9771 total=2, send clean, set 20s T, , 1U OP AOS0 I1N
10m5.9772 ZTP 100ms: tk=51, st=2, cb_tk=20 m_tk=20, f 1 C, unsta=0, , 1U OP AOS0 I1N
10m17.2617 Stk ZTP clean T: mode=0 SS running=0, has SS clean-T, reconfig=2, ZTP EN, reset: free: X
C0, deinit_rel: , 1U OP AOS0 I1N 99%
12m26.8255 ZTP chg_cb(old=0, new=1): I new-A, ZTP m=1 en, init, , 1U OP A1S0 I1A 7%
12m44.3562 topo chg: during ztp reload, abort.
, 2U OP A1S0 I1A
```

MIB support for ICX stack configurations

All statistics about packets received and sent, RMON, jumbo frames (greater than 1518 bytes), runts, giants, and other instances are gathered through the stack interfaces and are accessible through SNMP. MIB support for ICX stack configurations is the same as for a standard interface. Information includes types of modules, including optics modules.

ICX Stack Troubleshooting

- Problems commonly diagnosed with stack formation.....237
- Manually triggering stack diagnosis.....237
- Troubleshooting an unsuccessful stack build.....238
- Troubleshooting stack interactive-setup.....240
- Troubleshooting unit replacement issues.....241
- Checking hardware after an upgrade failure.....241
- Troubleshooting image copy issues.....243
- Configuration, startup configuration files, and stacking flash.....243
- Stacking unit role transition considerations.....244
- Port down and aging.....244

Problems commonly diagnosed with stack formation

The most common reason for an unsuccessful stack build is a hardware configuration mismatch, a software configuration mismatch, or a combination of both.

The following common problems may be encountered when building stacks:

- Ports on the same trunk connect to different units.
- Ports on the same trunk connect to different trunks on the same unit.
- Sub-ports of the 4 x 10-Gbps module are down.
- One end of a 10-Gbps port is up, but the other end is down.
- Communication problems exist between units in the stack.

A common connection error is that the two cables of a trunk go to different units or to different trunks on the same unit. A stack may still form in these cases, but the incorrect connection may cause an internal forwarding loop, or the unit may have forwarding problems.

Manually triggering stack diagnosis

You can manually trigger stack diagnosis using the **show stack connection** command. This command can provide additional detail on connections that are identified as problems.

Troubleshooting an unsuccessful stack build

If you are unable to build a stack (for example, the **show stack** command does not display any members), perform the following steps.

1. Enter the **show run** command on each unit to make sure the configuration contains "stack enable." If it does not, enter the **stack enable** command on the unit. Before a stack is formed, you can still access the console port on each device. Once a stack is successfully formed, you are redirected to the active controller.

NOTE

If you are building a stack using stack interactive-setup, you do not have to enter the **stack enable** command on each unit.

2. Check that all of your stacking port connections are secure and working properly. Enter **show interfaces stack** on each device to confirm that the stacking port links are up and the ports are in the forward state.

```
device# show interfaces stack
Port  Link  State  Dupl Speed  Trunk  Tag  P  MAC      Name
1/2/1 Up    Forward Full 10G   None   No   1  0000.00eb.a902
1/2/2 Up    Forward Full 10G   None   No   1  0000.00eb.a904
```

NOTE

When you use stack interactive-setup or stack zero-touch provisioning, data ports can be in the BLOCKING state if spanning tree is configured. However, stack interactive-setup probe packets can traverse blocked ports.

3. Confirm that all of the devices are running the same software image.
4. Use the **show log** command to display any IPC version mismatch messages. These messages appear in one minute when receiving mismatched probe packets, and then once every 10 minutes.

- Use the **show stack ipc** command to see if any traffic has been sent or received. Enter **clear stack ipc** to clear the traffic statistics and then enter **show stack ipc** again so you can easily see differences in traffic flow.

```

ICX7750-26Q Router# show stack ipc
V80, G4, src=748e.f8f9.6300, max_pkt_size=10264, delay_buf=10264
Recv: SkP0: 13788, P1: 16488, sum: 30276, since t=3028.1 ago
Message types have callbacks:
Send message types:
  [1]=12422,      [5]=12600,      [6]=3,          [7]=1145,
  [9]=875,       [13]=294,      [22]=17,       [24]=644,
  [28]=41,       [31]=2651,     [40]=15,       [60]=4,
  [77]=188,
Recv message types:
  [1]= 0:4609, 1:6737,      [5]= 0:6106, 1:6459,      [6]= 0:1, 1:2,
  [7]= 0:566, 1:579,      [9]= 0:1413, 1:1597,     [13]= 0:773, 1:789,
  [23]= 0:319, 1:325,     [34]= 0:1,
Statistics:
send pkt num      :      30890,   recv pkt num      :      30276,
send msg num      :      30890,   recv msg num      :      30276,
send frag pkt num :           0,   recv frag pkt num :           0,
pkt buf alloc     :      30897,
send_delay_msg    :           0,   send_delay_pkt    :           0,
fwd_stby_msg      :           0,   fwd_stby_pkt      :           0,

Reliable-mail     send  success  receive  duplic  T (us)
target ID         2      2         0        0     82226
target MAC        0      0         0        0     82226
unrel target ID   5              0
unrel target MAC  4              0
There is 0 current jumbo IPC session

Possible errors:

```

If the "Send message types" field is empty, **stack enable** has not been configured. If the number of "Recv IPC packets" increases, but there are no "Recv message types," then the packets are being dropped for various reasons, including the wrong IPC version, or a checksum error. The "Possible errors" field lists reasons for packet loss.

NOTE

A small "***state not ready" count is normal, but if it continues to increase, a problem is indicated.

- If the results of a **show stack** command show other stack members, but lists them as non-operational, this could be due to an image mismatch, or a configuration mismatch. In the event of an image mismatch, you can download the correct images to the entire stack from the active controller.

NOTE

If your intended stacking ports are connected in a ring topology, they will not all appear to be in the forwarding state because of Spanning Tree Protocol, but stack interactive-setup can still build the stack.

7. Check to be sure you do not have any stacking to non-stacking connections. All platforms use proprietary link negotiation to detect whether a stacking port's neighbors are also stacking ports. The platforms then convert both sides from IEEE mode (used in data ports) to HiGig mode (used in internal ports). Under stable conditions, both ends of a stacking link are converted to HiGig mode. If a stacking port is UP but in IEEE mode, its neighbor is not a stacking port. Enter the **show stack stack-ports** command to check if any stacking port is UP but in IEEE mode. The following example shows that U3 ports 3/2/1 to 3/2/3 are UP and in IEEE mode as indicated by the **up*** mark.

```
ICX7750-26Q Router(config-unit-3)# show stack stack-ports
              standby      active
  +----+      +----+      +----+
 2/1| 3 |2/4==2/4| 1 |2/1==2/1| 2 |
  +----+      +----+      +----+

U#  Stack-port1                Stack-port2
 1  up 1/2/1 to 1/2/3           up 1/2/4 to 1/2/6
    up ports: 1/2/1, 1/2/2, 1/2/3
    up ports: 1/2/4, 1/2/5, 1/2/6

 2  up 2/2/1 to 2/2/3           none
    up ports: 2/2/1, 2/2/2, 2/2/3
    up ports: 1/2/4, 1/2/5, 1/2/6

 3  up* 3/2/1 to 3/2/3          up 3/2/4 to 3/2/6
    up ports: 3/2/1, 3/2/2, 3/2/3
    up ports: 3/2/4, 3/2/5, 3/2/6
```

Note: *: Port is up in IEEE mode, not in HiGig mode.

8. If you run out of flash memory while performing a **write memory**, your stack devices may contain very large startup-config.v4 or startup-config.old files, which are preserved for recovery purposes. Enter the **show dir** command at the privileged EXEC level to see all flash files. If you identify these old files and they are not needed, you can delete them by entering the **flash delete** command at the privileged EXEC level as shown in the following example.

```
ICX7450-48F Router# show dir
Type      Size      Name
-----
F          27615428 primary
F          27851652 secondary
F              21 sil_logs
F           2361 startup-config.backup
F           2361 startup-config.old
F           2442 startup-config.txt
F            256 secondary.sig
F            256 bootrom.sig
F           77002 debug.boot

55551779 bytes 9 File(s) in FI root

1766779193 bytes free in FI root
1766779193 bytes free in /

ICX7450-48F Router# flash delete
ASCII string flash file name to delete
ICX7450-48F Router# flash delete startup-config.old
```

Troubleshooting stack interactive-setup

Stack interactive-setup can be used to form linear and ring stack topologies. For information about the procedure, refer to [Scenario 1 - Using stack interactive-setup to create a stack](#) on page 57.

If stack interactive-setup does not detect all the units that should be detected, perform the following checks:

- Make sure that all the cables are properly connected.
- Make sure that all the relevant ports are in the UP state.
- Make sure that all the units are running the same image.
- Issue the **stack enable** command only on the unit that will serve as the active controller.
- Make sure that **stack disable** is not configured on any prospective members (for example, by entering the **show running-config** command on the unit).
- Check to see if spanning tree protocols (STP, RSTP, PVST, or MSTP) are configured either globally or on the default VLAN. Connecting new links or new units without configuring spanning tree protocols creates Layer 2 loops. Loops cause high traffic count on the affected ports and may cause high CPU utilization if the looped packets are trapped to the CPU. Stack interactive-setup and many functions may not work properly in a looped environment.

NOTE

Ruckus recommends that you configure STP globally or on the default VLAN before making new stacking connections. If the system is already experiencing loops before you configure STP, STP may not converge when the looping packets have higher priority than STP's BPDU packets. Refer to [Stacking deployment guidelines](#) on page 34 for information on handling loops.

If stack interactive-setup times out (this may happen due to inactivity), you will not be able to make any changes in your configuration or stack topology until you restart the session by entering the **stack interactive-setup** command.

Troubleshooting unit replacement issues

The unit replacement process is intended to replace one unit with a clean unit of exactly the same model without entering any command. Unit replacement is not designed to discover new units. Refer to **Replacing stack units** in [Stacking deployment guidelines](#) on page 34 for more information.

- The replacement unit is a clean unit (does not contain a startup-config.txt file).
- The replacement unit running configuration does not contain the **stack enable** command.
- The replacement unit running configuration does not contain the **stack disable** command.
- The configurations for the stack ports on the active controller match the physical connections to the unit.
- You can replace only one unit at a time. If the active controller detects multiple new units, it issues warning messages.
- The clean unit must match only one reserved stack unit configuration. The active controller issues warning messages if the new unit matches multiple units.
- The console of the new unit displays a warning message if the unit receives unit-replacement packets when it does not qualify for unit replacement.

Checking hardware after an upgrade failure

You can perform a few basic checks if you suspect a hardware failure.

When the system resets as the result of an upgrade failure, you may see output similar to the following example.

```
##### LOGS #####  
Sent SIGTERM to all processes  
Sent SIGKILL to all processes  
Requesting system reboot
```

ICX Stack Troubleshooting

Checking hardware after an upgrade failure

Restarting system.

Ruckus Bootloader: 10.1.05b008T215 (Jul 08 2015 - 07:49:47)

```
Validate Shmoo parameters stored in flash ..... OK
Restoring Shmoo parameters from flash .....
Running simple memory test ..... OK
ICX7450-48 Fiber (Non-POE), A1
SYS CPLD VER: 0xe, Released Ver: 0
CPLD1 VER: 0xf, Released Ver: 0
CPLD2 VER: 0xf, Released Ver: 0
```

Enter 'b' to stop at boot monitor: 0

1. To stop the reset and open the boot prompt, enter **b**.
2. At the boot prompt, enter the **hwinfo** command to display basic hardware information as shown in the following example.

```
ICX7450-Boot> hwinfo
SKU                               : 48 Fiber (Non-POE), A1
System CPLD Version               : 0xe
CPLD1 Version                     : 0xf
CPLD2 Version                     : 0xf
CPLD Chip Select                  : 1
Bank Select                       : 0
Watchdog PCA9561 Enabled          : 0
Watchdog Enabled                  : 0x30
Booted from                       : 1
Uboot partition 1 Failure Record  : 0
Uboot partition 2 Failure Record  : 0
Reset Cause                       : WARM_RESET (CPU_RESET_REQ)
Write Protect NOR Enabled         : 0
Write Protect RCW Enabled         : 0
Write Protect PCA9561 Enabled     : 0
```

3. To verify installed image files, enter the **show_image** command at the boot prompt as shown in the following example.

```
ICX7450-Boot> show_image
=====
Primary   : SPS08030b(28590276)
Secondary: SPR08030b(31547588)
```

4. To reset hardware and memory, enter the **powercycle** command at the boot prompt. This causes the system to execute a cold boot as shown in the following example.

```
ICX77xx-Boot> powercycle

Bootloader Version: 10.1.01T205 (Jun 11 2014 - 16:29:55)

SVR: 0x82180111, PVR: 0x80230022
Sidewinder:48C,A1
SYS CPLD VER: 0xe, Released Ver: 0
Enter 'b' to stop at boot monitor: 0
bootdelay: ===
Booting image from Secondary
## Booting kernel from Legacy Image at 0300a200 ...
   Created:    2015-02-19   6:23:46 UTC
   Data Size:  17787567 Bytes = 17 MiB
   Load Address: 00000000
   Entry Point: 00000000
   Verifying Checksum ... OK
   Uncompressing Kernel Image ... OK
setup_arch: bootmem
```

Troubleshooting image copy issues

The **copy tftp flash** command copies the image to all stack units including the active controller. The **copy flash flash** command copies the image from the primary or secondary flash on the active controller to the primary or secondary flash image of a stack member. If you are unable to copy an image to one or more stack units, check the following:

- Make sure the unit is actually part of the stack. Use the **show stack** command.
- If a unit joins a stack after the **image copy** command was issued, you will need to copy the image to this unit separately.

Configuration, startup configuration files, and stacking flash

Stacking system behavior is defined by the runtime configuration, which can be displayed using the **show running-config** command. The **write memory** command stores the runtime configuration in a flash file called startup-config.txt. During bootup, the system reads and applies the startup-config.txt file to the runtime configuration. The startup-config.txt file can be shown using the **show config** command.

The stacking system installs a stacking.boot file on each unit that tells the unit what its role is during the boot process. The stacking.boot file is generated whenever there is an election that defines the roles for all units.

When an active controller is booted or a **write memory** command is issued, the active controller synchronizes its startup-config.txt file to every stack unit. The original startup-config.txt files in the standby controller and other stack members are renamed to startup-config.old. If you issue the **stack unconfigure me** command on the standby controller or stack member directly, these units recover their original startup-config.txt files and reboot as standalone devices. If you enter the **stack unconfigure all** command from the active controller, all devices recover their old startup-config.txt files and become standalone devices. When this happens, the startup-config.old file is renamed to startup-config.txt, and the stacking.boot file is removed.

Whenever a stack unit configuration parameter, such as the priority setting, is changed, an election is held to determine the active controller, and the result is written into the stacking.boot file. A prompt message appears on the console that recommends you use the **write memory** command. For an active controller role change to take effect, you must reset the entire stack.

If you do not use the **write memory** command but reset the stack, the stack units continue to operate in their roles as defined by the stacking.boot file. After the reset, each unit readjusts based on the current runtime configuration. However, you may observe different results depending on what has not been saved. If you have renumbered the stack unit IDs, you may see a configuration mismatch because your changes no longer match the active controller configuration.

If you change priorities to elect an active controller, the new active controller assumes its role after a reboot, whether or not you have used the **write memory** command. If you do not save your priority change before the next reboot, the reboot triggers an election that may result in a different winner based on the priority in the unsaved configuration. The new winner assumes the active controller role after the next reboot.

If you change the stacking port configuration and do not save your changes, you may encounter connectivity errors. To recover from a configuration error, define the correct stacking port by running stack interactive-setup.

NOTE

You should always execute the **write memory** command after making stacking-related configuration changes such as changing priority or changing stacking ports. If you do not want to keep the changes, change the configuration back to the previous version, and then execute the **write memory** command. Do not discard configuration changes by using a reset without executing the **write memory** command.

Stacking unit role transition considerations

An active or standby controller contains the stacking system configuration and its internal data structures. When an active or standby controller becomes a member, the configuration and data structures are not cleared. This does not affect its capability to function as a member. However, if the user changes the configuration, this member unit cannot become a standby again because of the difference in configuration. A member unit can become a standby only if the member was never a standby or active controller (with no configuration) or if it has the same configuration as the current active controller.

Port down and aging

Aging is only used as a safeguard. If a unit is powered down or the stacking link is removed, the system immediately detects that the port is down and knows that its neighbor is gone. That unit is immediately removed from the active controller.

If a stacking port does not receive keep-alive messages from its neighbor within 60 seconds, it ages out the neighbor. When a unit is no longer stack-enabled or when one stacking port becomes a non-stacking port, it sends a notification that the port is no longer a stacking port. When the neighboring port receives the notification from its neighbor, it immediately removes the neighbor.

The following message is logged and displayed when a port is aged out.

```
Warning! my mac=0000.004f.4243, age out up-stream
```



© 2019 ARRIS Enterprises LLC. All rights reserved.
Ruckus Wireless, Inc., a wholly owned subsidiary of ARRIS International plc.
350 West Java Dr., Sunnyvale, CA 94089 USA
www.ruckuswireless.com